

.....	3
General Description	3
.....	3
.....	3
.....	4
.....	5
.....	7
.....	8
.....	11
.....	11
.....	12
.....	13
.....	14
.....	15
.....	15
.....	17
.....	17

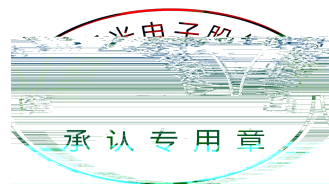

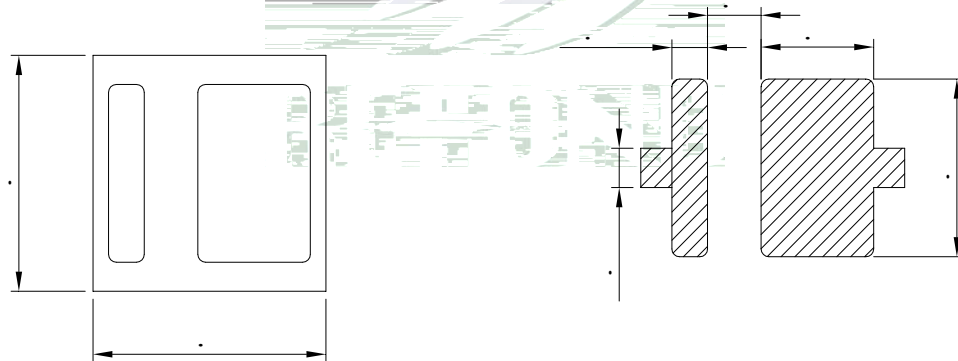

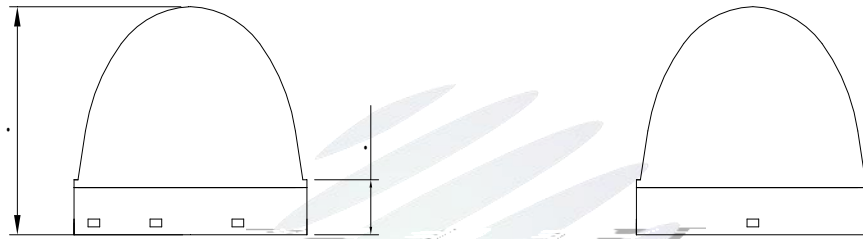
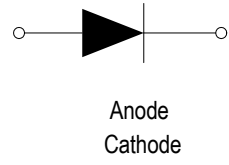
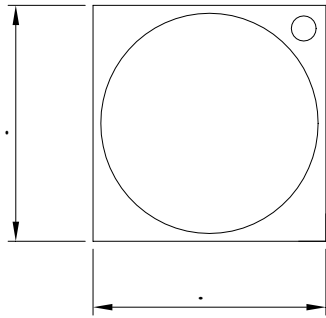

±

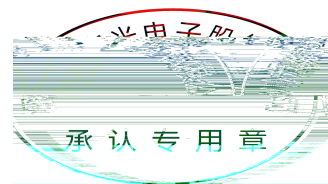

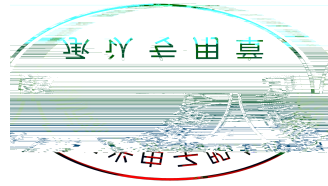

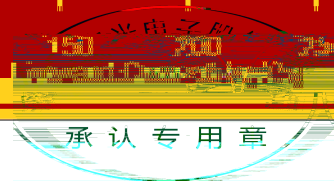
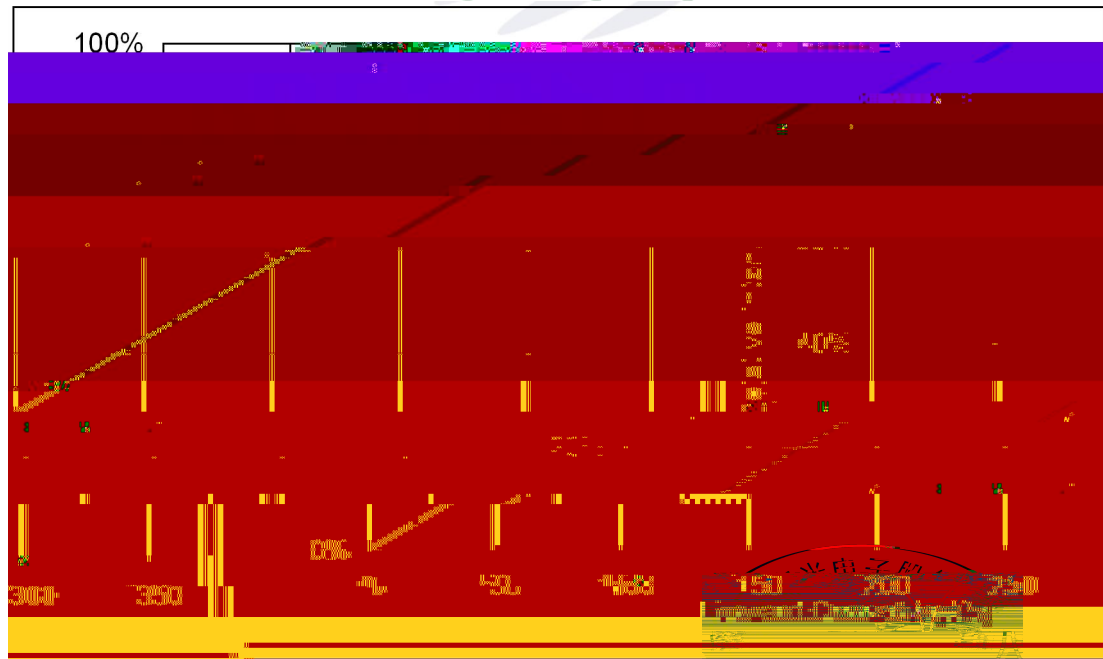
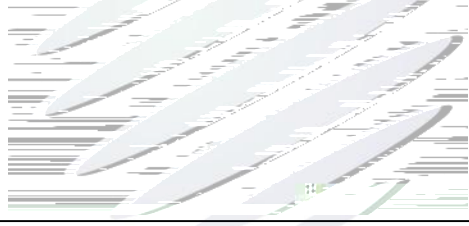
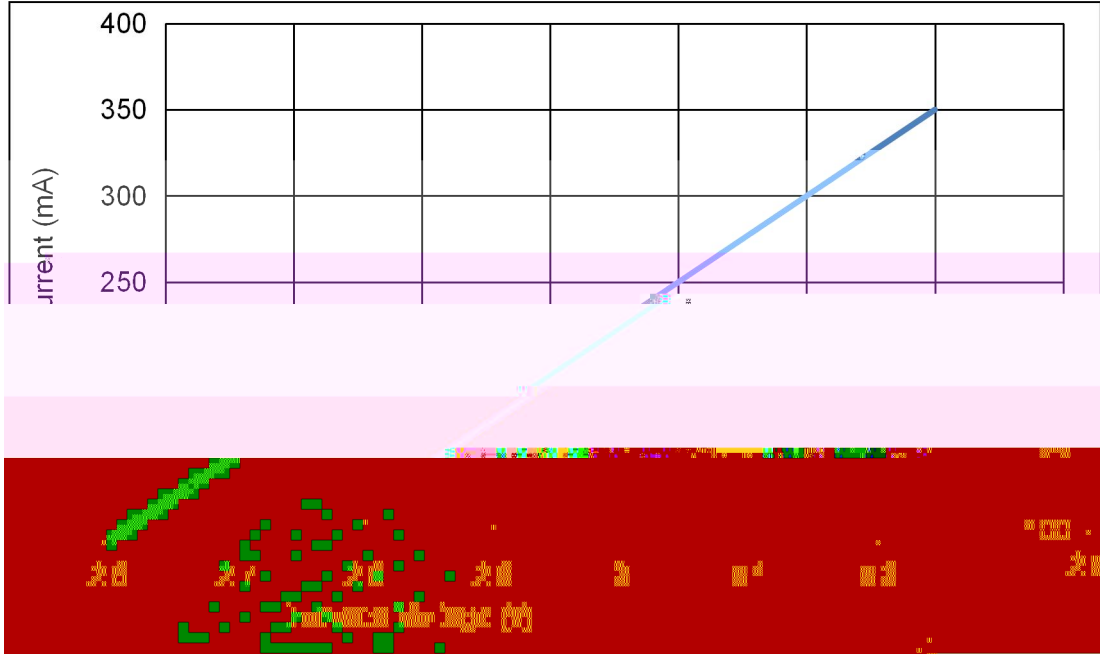

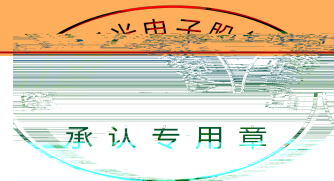
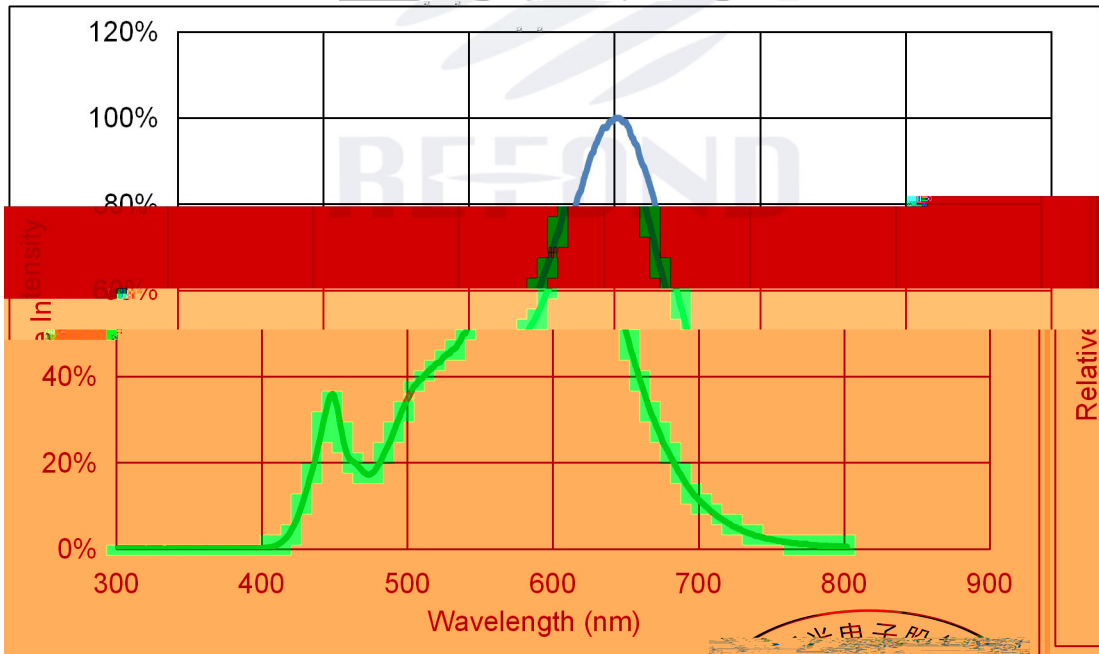
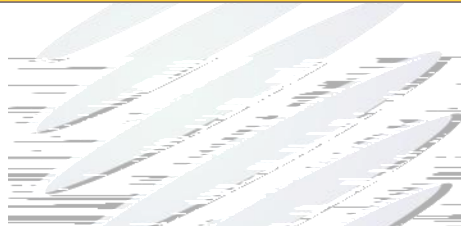
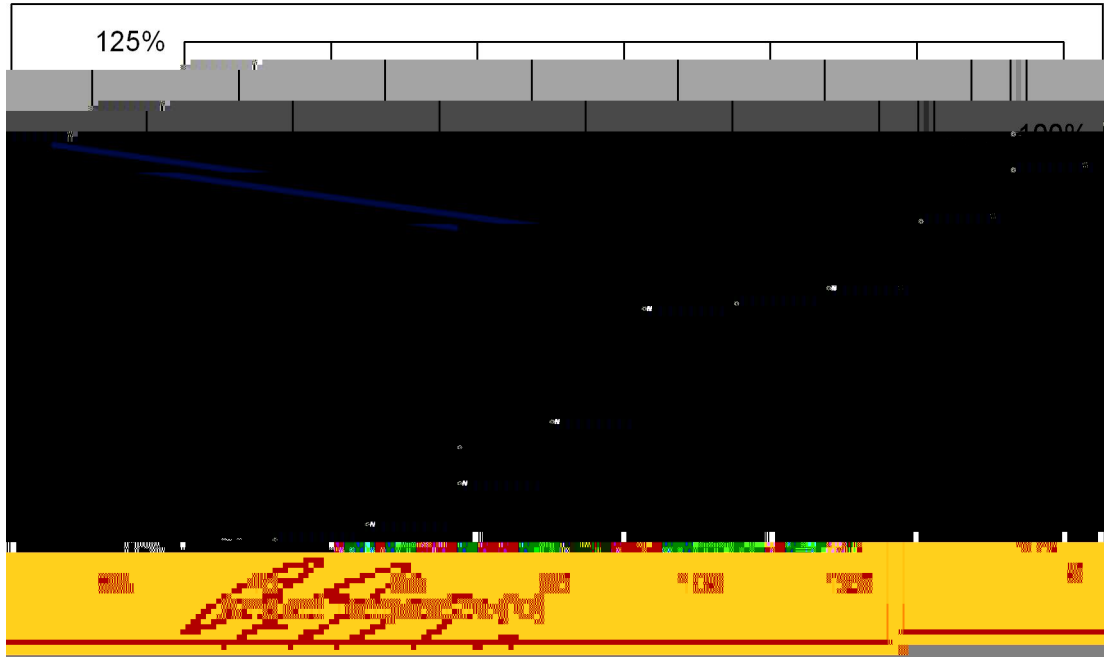

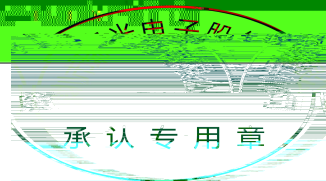
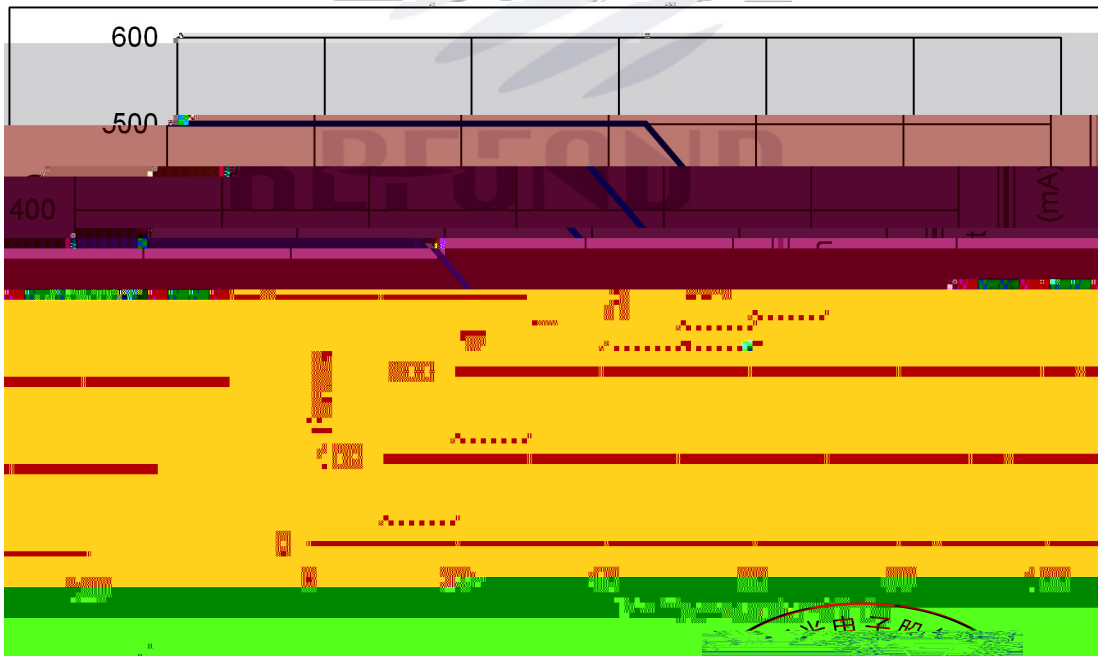
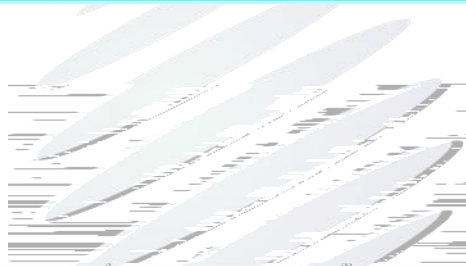
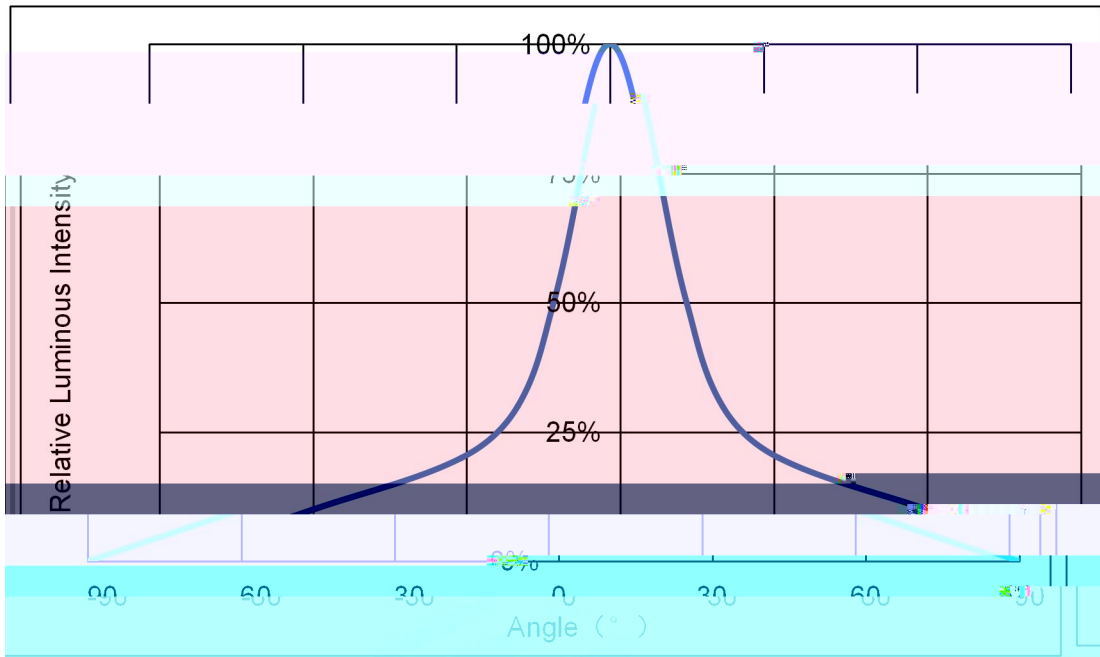

2500

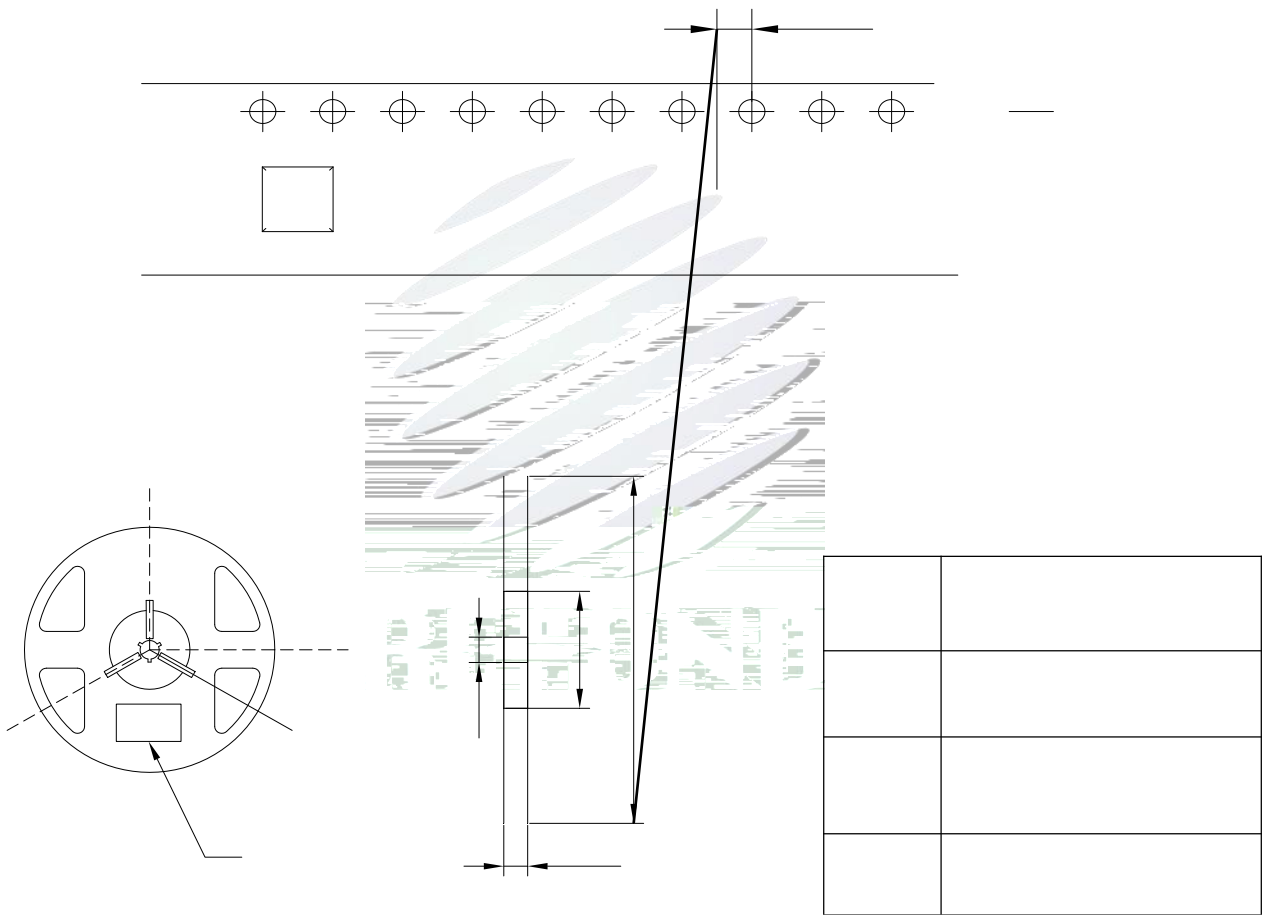

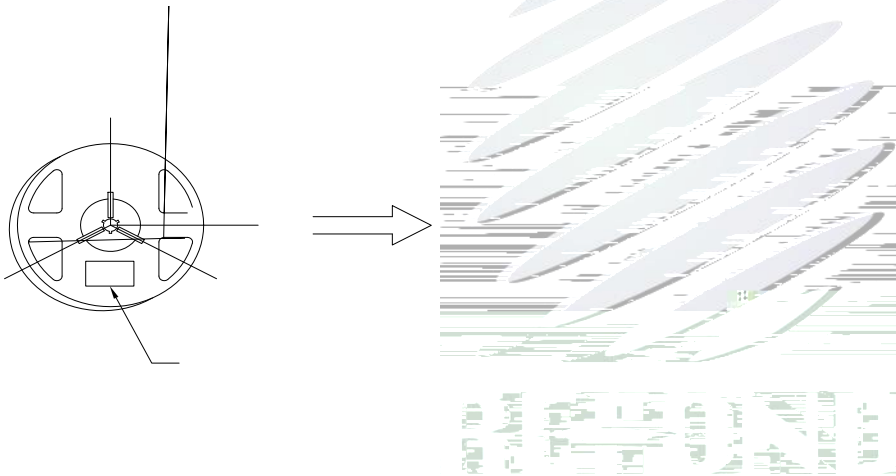

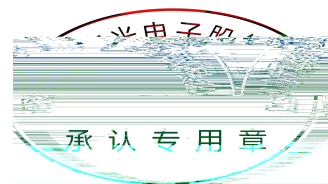

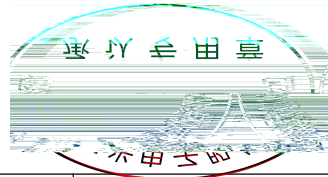

Luminous Flux				



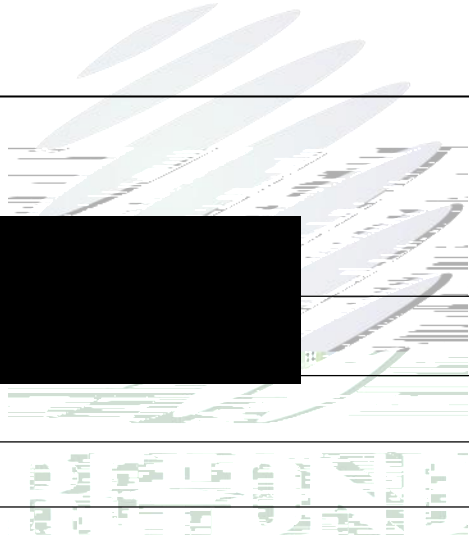
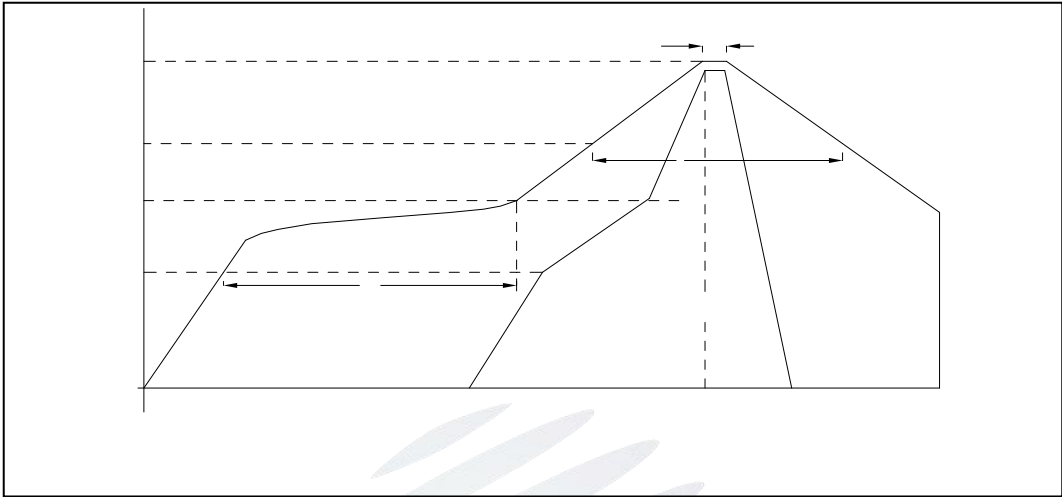

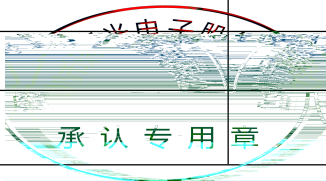

°C

