

SPECIFICATION

REFOND P/N

Mass Product

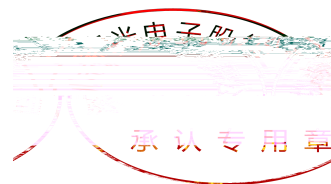

Contents

1. Description	
1.1 General Description	
1.2 Features	
1.3 Application	
1.4 Package Dimension	
1.5 Product Parameters	
1.6 Typical Optical Characteristics Curves	
2. Packaging	
2.1 Packaging Specification	
2.1.1 Carrier Tape Dimension	11
2.1.2 Reel Dimension	11
2.1.3 Label Form Specification	11
2.2 Moisture Resistant Packing	
2.3 Cardboard Box	
2.4 Reliability Test Items And Conditions	
2.5 Criteria For Judging Damage	
3. SMT Reflow Soldering Instructions SMT	
3.1 SMT Reflow Soldering Instructions SMT	
4. Handling Precautions	
4.1 Handling Precautions	

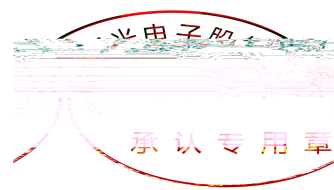
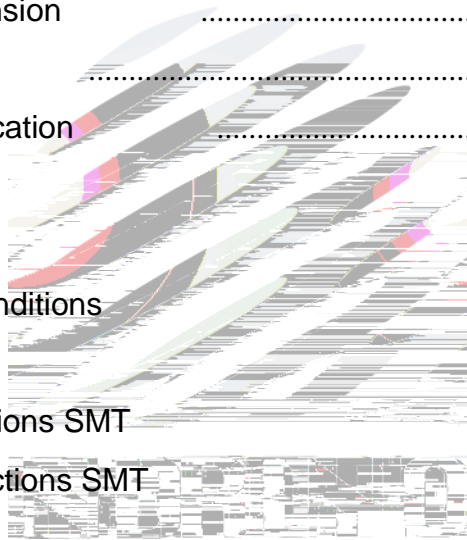

1. Description

1.1 General Description

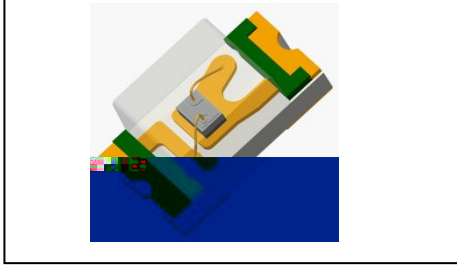

The Colour LED which was fabricated using a green chip Package Dimension : 1.6mmX0.8mmX0.7mm.

LED

1.6mmX0.8mmX0.7mm

1.2 Features

- Extremely wide viewing angle.
- Suitable for all SMT assembly and solder process.
- Moisture sensitivity level: Level 3.
- RoHS compliant.

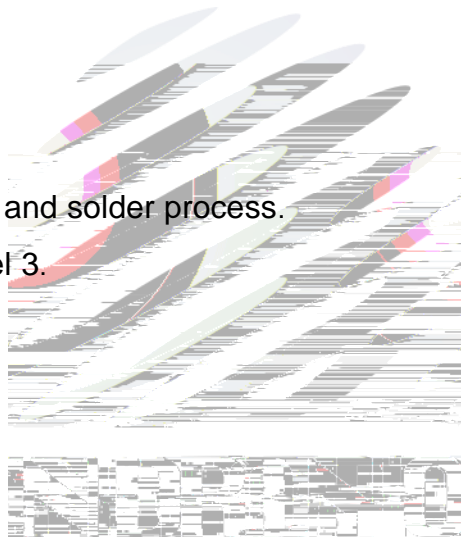

1.3 Application

- Optical indicator.
- Switch and symbol, display.
- General use.

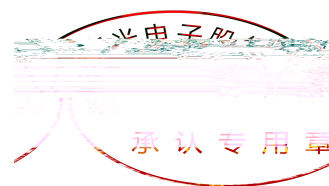

1.4 Package Dimension

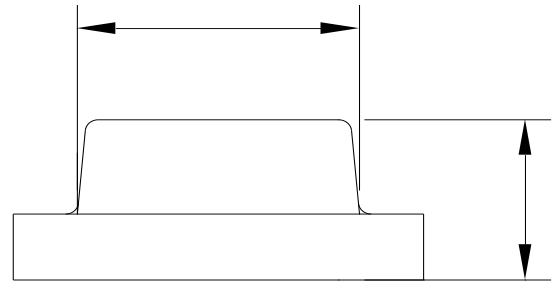

Fig.1-2 Side view

Fig.1-1 Top view

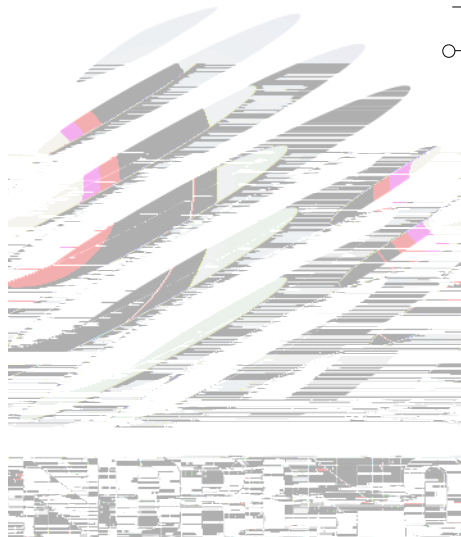

Fig.1-3 Bottom view

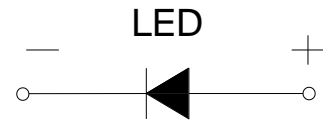

Fig.1-4 Polarity

Fig.1-5 Soldering patterns

Notes

All dimensions units are millimeters.

All dimensions tolerances are 0.2mm unless otherwise noted.

1.5 Product Parameters

Table 1-1 Electrical / Optical Characteristics at Ts=25°C

Item	Test Condition	Symbol		Value			Unit
				Min. ()	Typ.	Max.	
Spectral Half Bandwidth	$I_F=5\text{mA}$			--	30	--	nm
Forward Voltage	$I_F=5\text{mA}$	V_F	F0	2.6	--	2.8	V
			G0	2.8	--	3.0	V
			H0	3.0	--	3.2	V

I_0

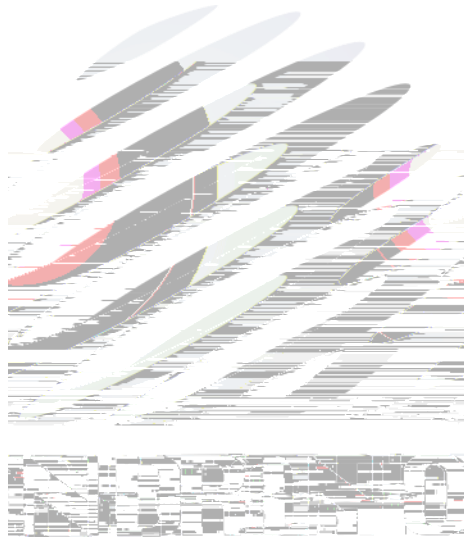

Notes : $V_R=5\text{V}$ For test conditions. $V_R=5\text{V}$

V

Table 1-2 Absolute Maximum Ratings at Ts=25°C

Parameter	Symbol	Rating	Units
Power Dissipation	P_d	68	mW

Notes

- 1/10 Duty cycle, 0.1ms pulse width.
- The above forward voltage measurement allowance tolerance is $\pm 0.1V$.
- The above dominant wavelength measurement allowance tolerance is $\pm 2nm$.
- The above luminous intensity measurement allowance tolerance $\pm 10\%$.
- Care is to be taken that power dissipation does not exceed the absolute maximum rating of the product.
- All measurements were made under the standardized environment of Refond.
- When the LEDs are in operation the maximum current should be decided after measuring the package temperature, junction temperature should not exceed the maximum rate

1.6 Typical Optical Characteristics Curves

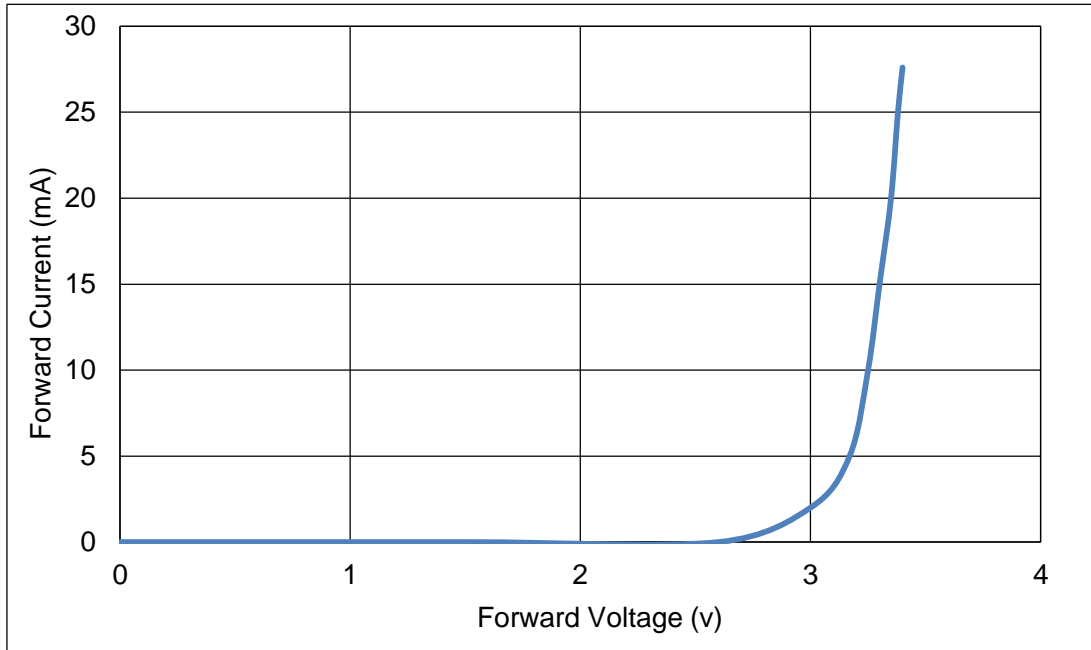
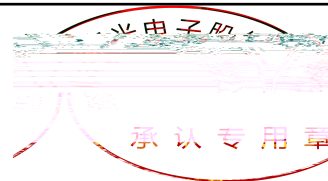

Fig 1-6 Forward Voltage Vs. Forward Current



Fig 1-7 Forward Current Vs. Relative Intensity



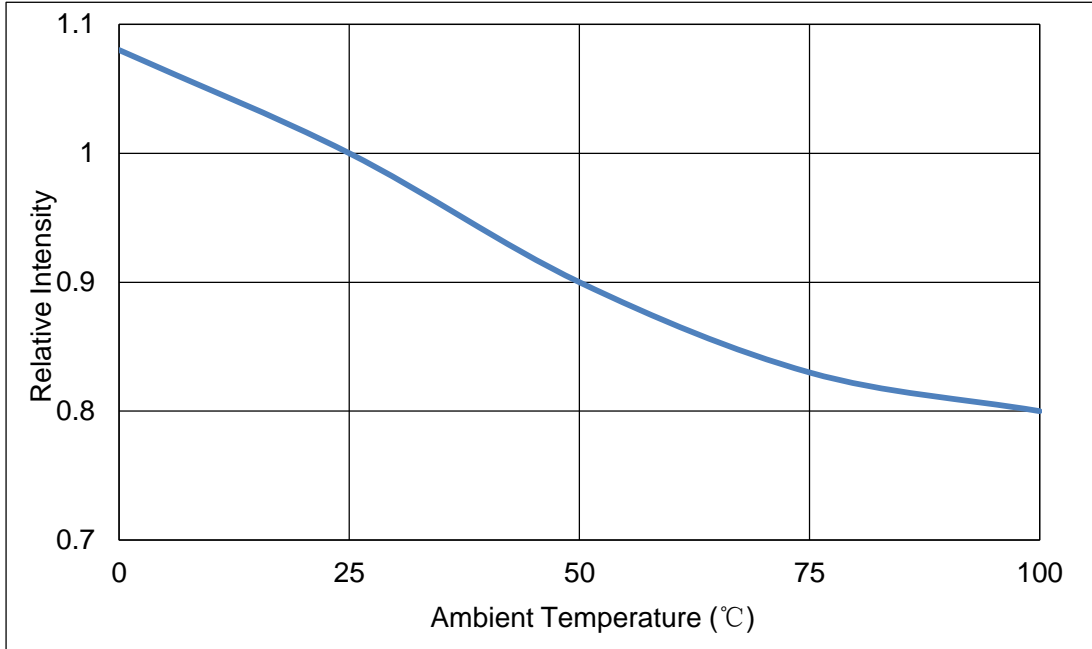

Fig 1-8 Pin Temperature Vs Relative Intensity

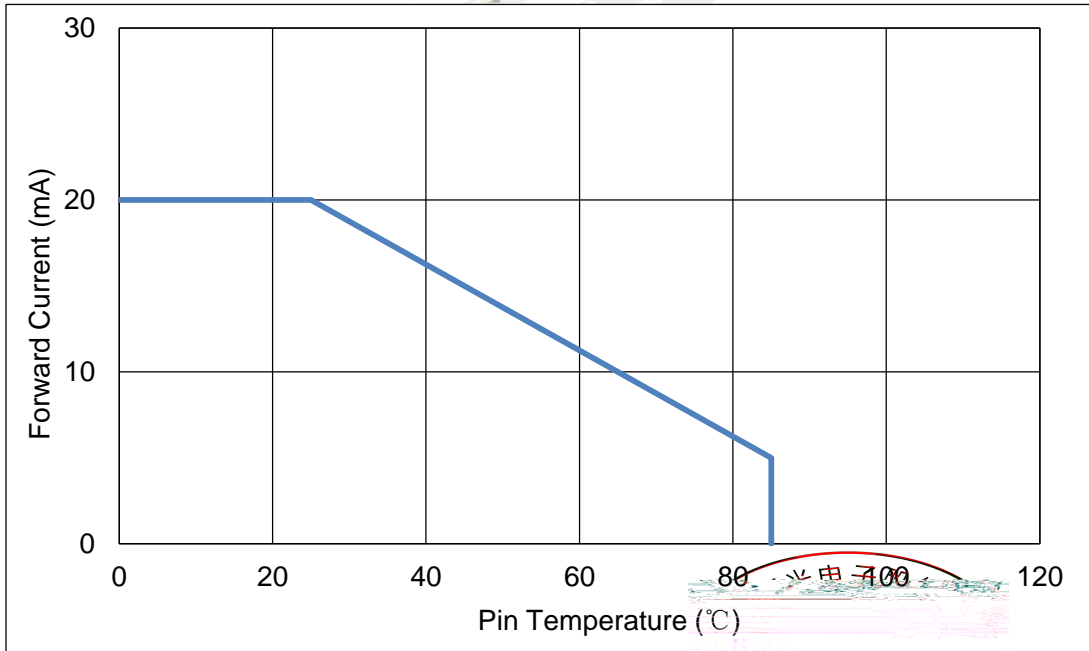
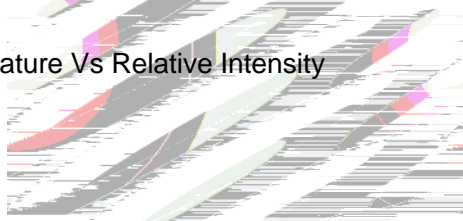

Fig 1-9 Pin Temperature Vs Forward Current

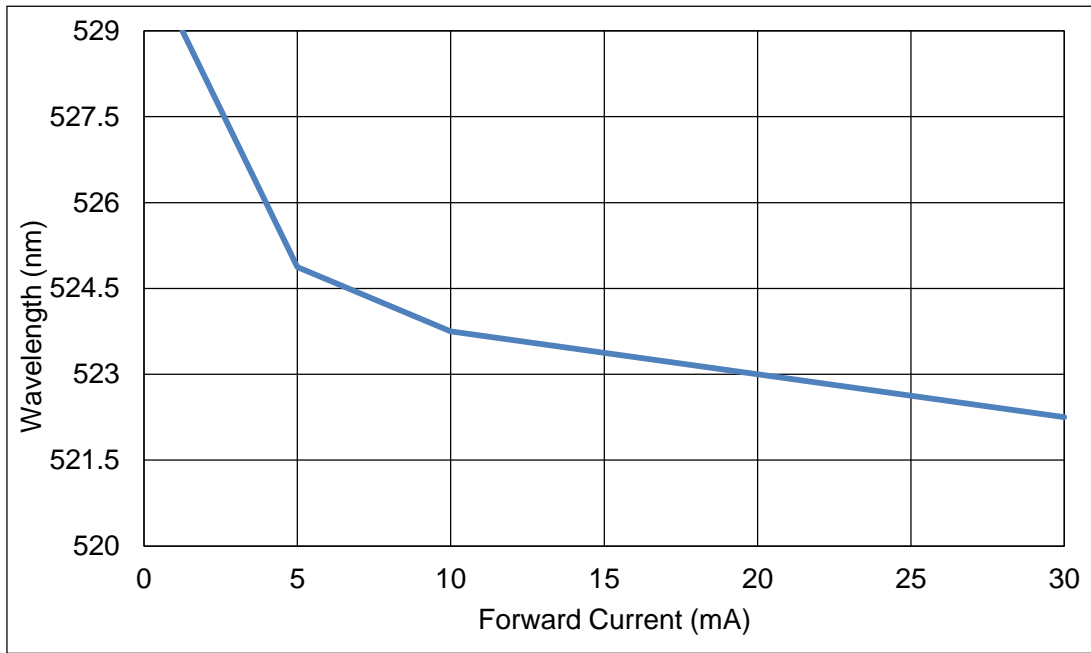

Fig 1-10 Forward Current Vs. Dominate Wavelength (Ta=25°C)

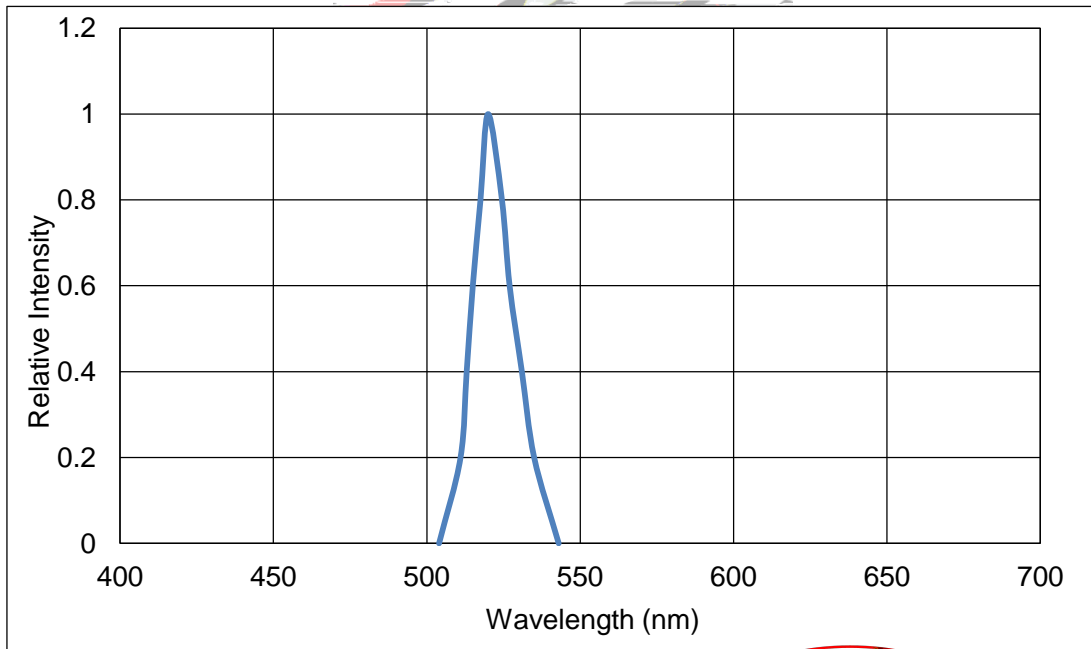
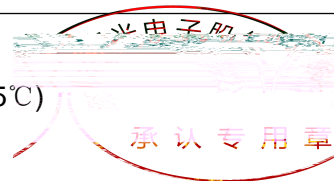

Fig 1-11 Relative Intensity Vs. Wavelength (Ta=25°C)



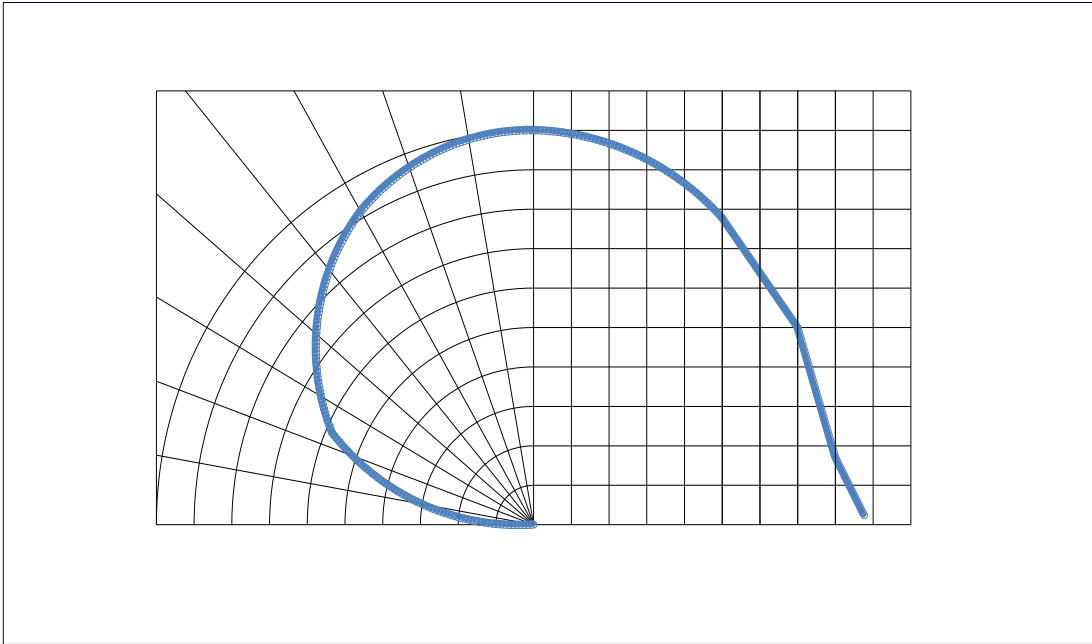
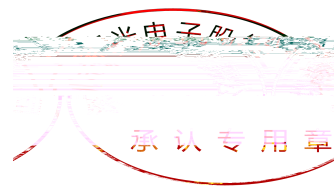
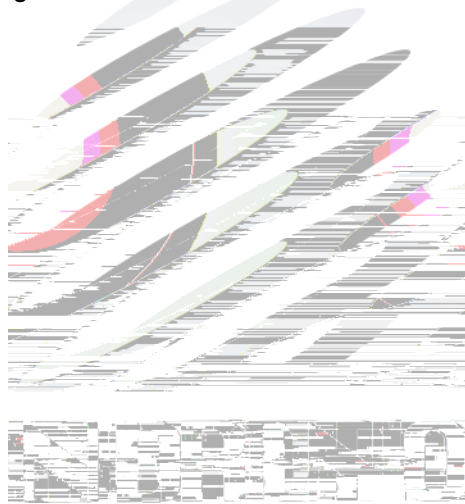

Fig 1-12 Diagram characteristics of radiation



2. Packaging

2.1 Packaging Specification

Package:4000pcs/reel.

4000pcs

2.1.1 Carrier Tape Dimension

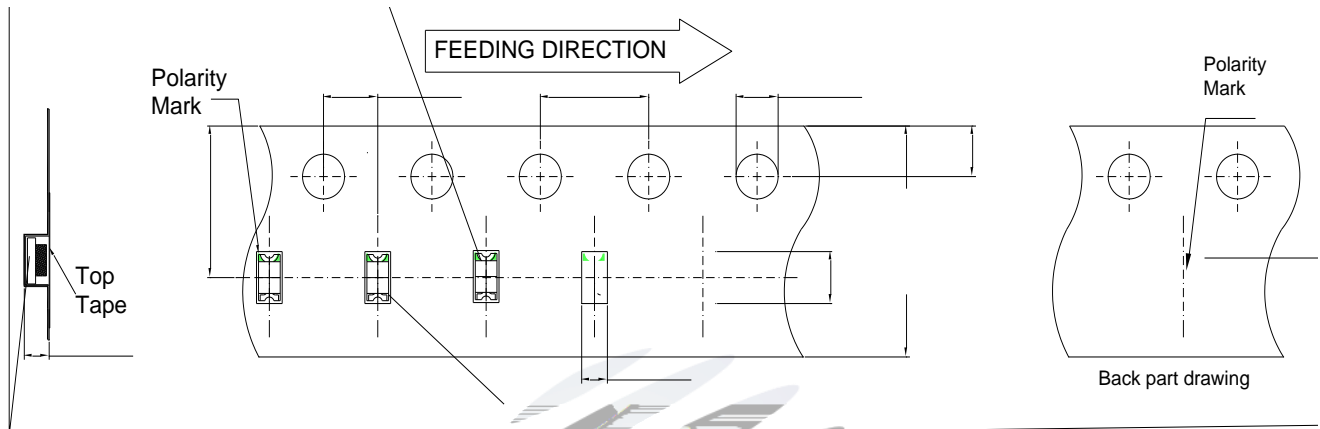

Fig.2-1 Carrier Tape Dimension

2.1.2 Reel Dimension

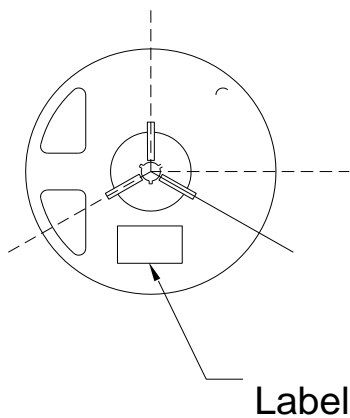

Fig.2-2 Reel Dimension

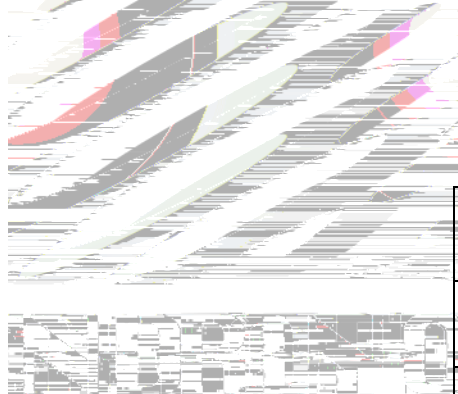

Table 2-1 Dimension

A	8.0 0.1mm
B	178 1mm
C	60 1mm
D	13.0 0.5mm

Notes

The tolerances unless mentioned $\pm 0.1\text{mm}$. Unit : mm

2.1.3 Label Form Specification

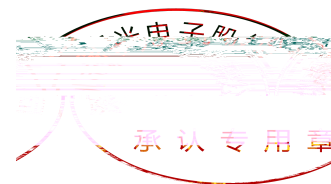

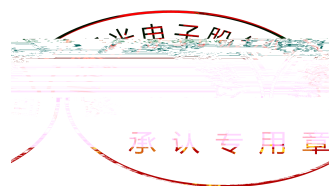
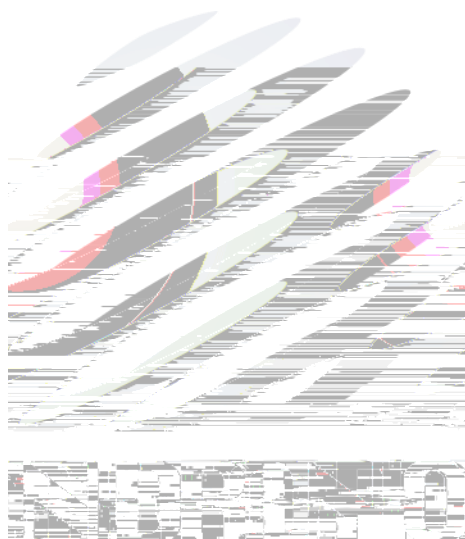

2.3 Cardboard Box

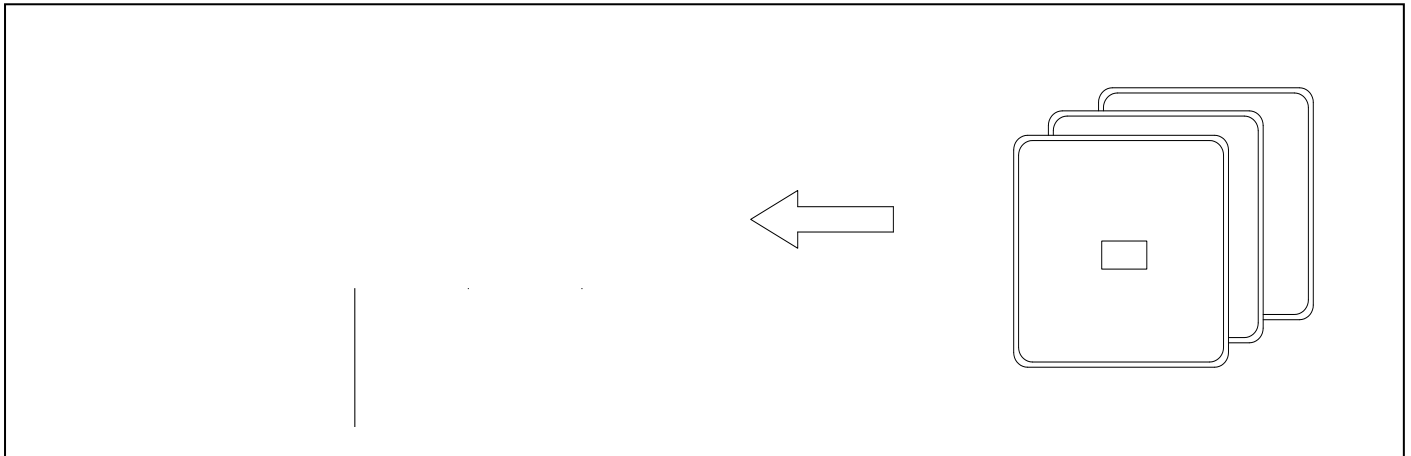
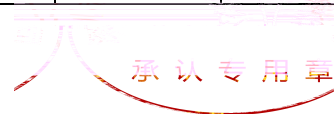

Fig.2-5 Cardboard Box

2.4 Reliability Test Items And Conditions

Table 2-3 Reliability Test Items And Conditions

Test Items	Ref.Standard	Test Condition	Time	Quantity	Ac/Re /
Reflow	JESD22-B106	Temp:260 max T=10 sec	2 times	22Pcs.	0/1
Temperature Cycle	JESD22-A104	100 30 min 5 min -40 30 min	50 cycles	22Pcs.	0/1
Thermal Shock	JESD22-A106	-40 15min 100 15min	150 cycles	22Pcs.	0/1
High Temperature Storage	JESD22-A103	Temp:100	500 hrs.	22Pcs.	0/1
Low Temperature Storage	JESD22-A119	Temp:-40	500 hrs.	22Pcs.	0/1
Life Test	JESD22-A108	T _a =25 I _f =5mA	500 hrs.	22Pcs.	0/1



2.5 Criteria For Judging Damage

Table 2-4 Criteria For Judging Damage

Test Items	Symbol	Test Condition	Criteria For Judgement	
			最小	Max.
Forward Voltage	V_F	$I_F=5mA$	-	U.S.L*)x1.1
Reverse Current	I_R	$V_R= 5V$	-	U.S.L*)x2.0
Luminous Flux		$I_F=5mA$	L.S.L*)x0.7	-

Notes

1.U.S.L: Upper standard level

L.S.L: Lower standard level

2.The above reliability tests is based on the verification of a

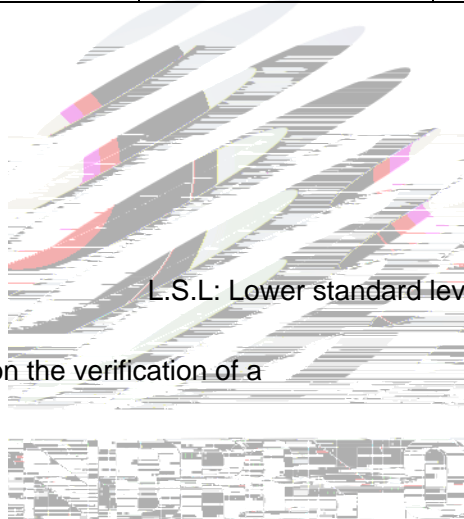

3. SMT Reflow Soldering Instructions SMT

3.1 SMT Reflow Soldering Instructions SMT

Fig.3-1 SMT Reflow Soldering Instructions SMT

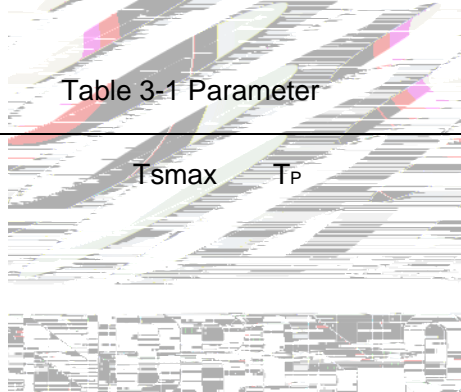

Table 3-1 Parameter

Average temperature rise speed

T_{smax} T_P

3 °C/ Max 3 °C/ s

Notes

(1)Reflow soldering should not be done more than twice. If more than 24 hours between the two solderings , LED will be damaged.

(2)When soldering , do not put stress on the LEDs during heating.

3.1.1 Soldering Iron

(1) When do soldering by hand, keep the temperature of iron below less 300°C less than 3 seconds.

(2) Soldering by hand should be done only one time.

3.1.2 Repairing

Repairing should not be done after the LEDs have been soldered. When repairing is unavoidable,a double-head soldering iron should be used (as below figure). It should be confirmed in advance whether the characteristics of LEDs will or not be damaged by repairing.

LED

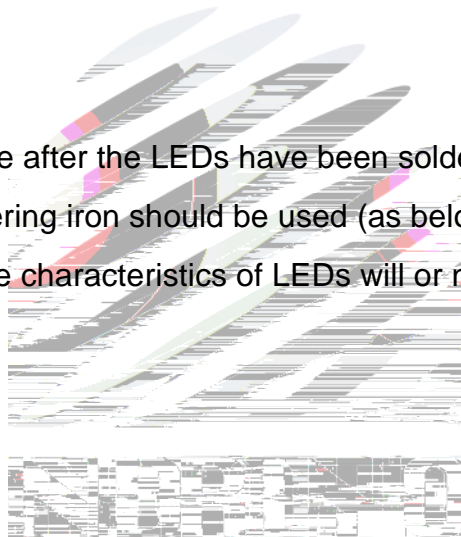

3.1.3 Cautions

(1) Components should not be mounted on warped (non coplanar) portion of PCB. After soldering, do not warp the circuit board.LED

(2) Do not apply mechanical force or excess vibration during the cooling process to normal temperature after soldering. Do not rapidly cool device after soldering.

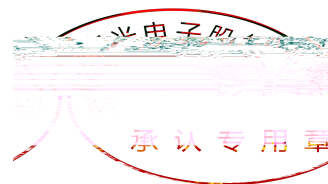

4. Handling Precautions

4.1 Handling Precautions

(1) LED operating environment and sulfur element composition cannot be over 100PPM in the LED mating usage material. This is provided for informational purposes only and is not a warranty or endorsement. LED

(2) In order to prevent external material from getting into the inside of LED, which may cause the malfunction of LED, the single content of Bromine element is required to be less than 900PPM, the single content of Chlorine element is required to be less than 900PPM, the total content of Bromine element and Chlorine element in the external materials of the application products is required to be less than 1500PPM. This is provided for informational purposes only and is not a warranty or endorsement.

(3) VOCs (Volatile organic compounds) emitted from materials used in the construction of fixtures can penetrate silicone encapsulants of LEDs and discolor when exposed to heat and photonic energy. The result can be a significant loss of light output from the fixture. Knowledge of the properties of the materials selected to be used in the construction of fixtures can help prevent these issues. Refond advises against the use of any chemicals or materials that have been found or are suspected to have an adverse affect on device performance or reliability. To verify compatibility, Refond recommends that all chemicals and materials be tested in the specific application and environment for which they are intended to be used. Attaching LEDs, do not use adhesives that outgas organic vapor.

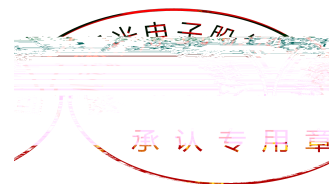

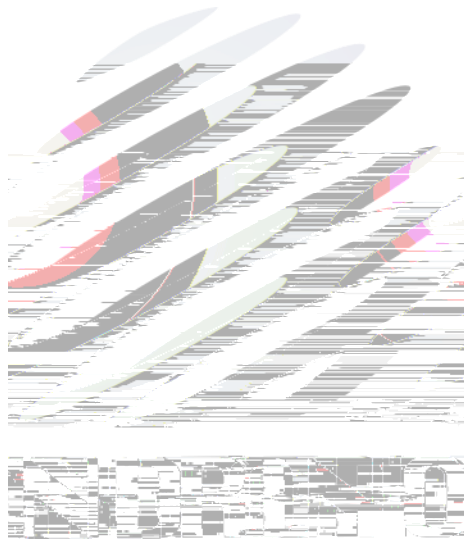

(8) Similar to most Solid state devices; LEDs are sensitive to Electro-Static Discharge (ESD) and Electrical Over Stress (EOS).

(9) Other points for attention, please refer to our relevant information.

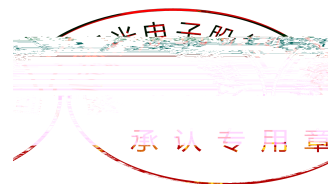
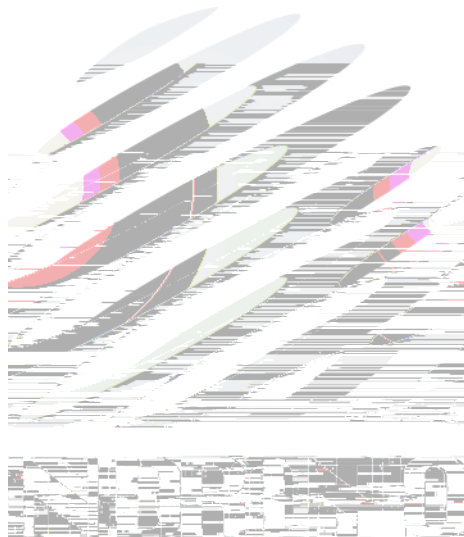

Date	Revisor	Version	Remarks
2020.08.31		E/0	
2021.5.10		E/1	

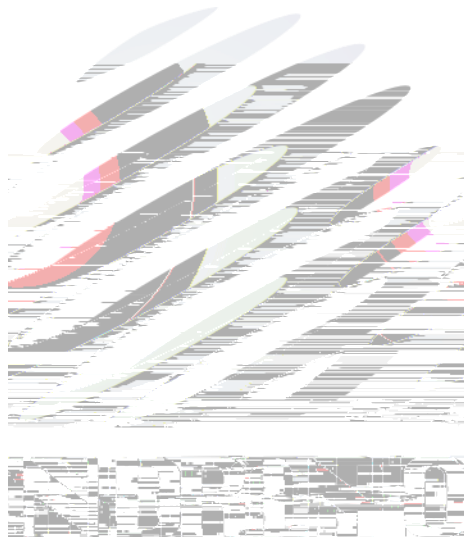

--	--	--	--	--

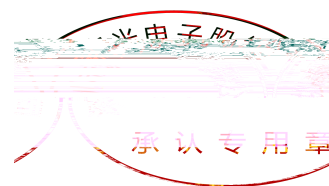



Declare

This specification is written both in English and in Chinese and the latter is formal.

