

General Description	3
	3
	3
	3
	4
	5
	7
	11
2.1.5	11
	12
	13
	13
	14
	15
	15
	17
	17

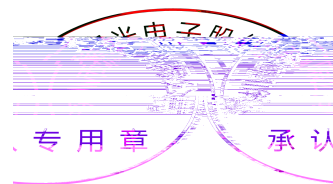

LED

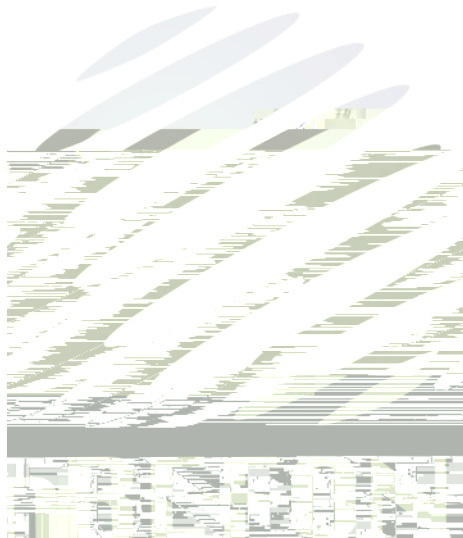

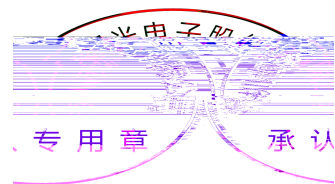
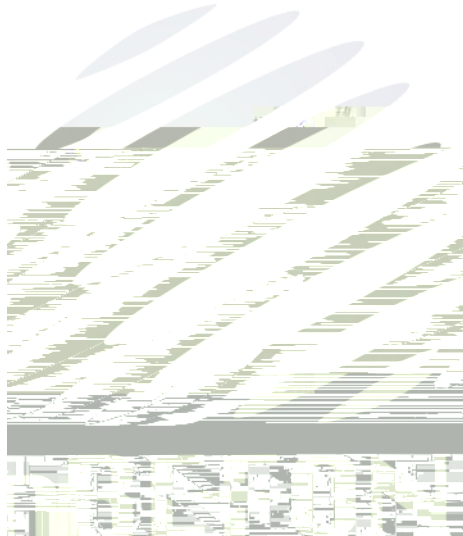
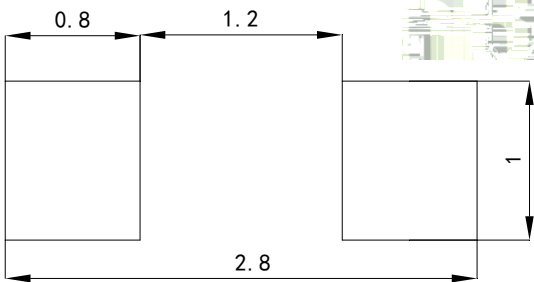
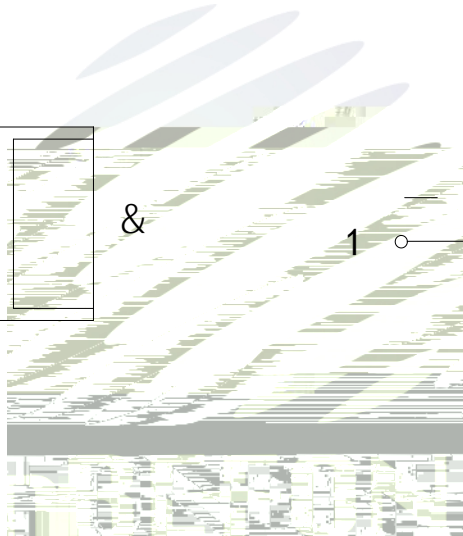
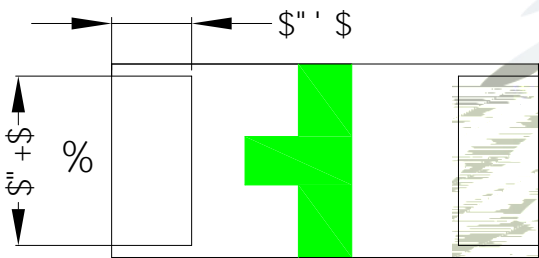
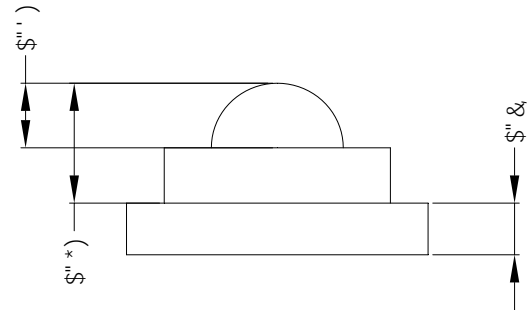
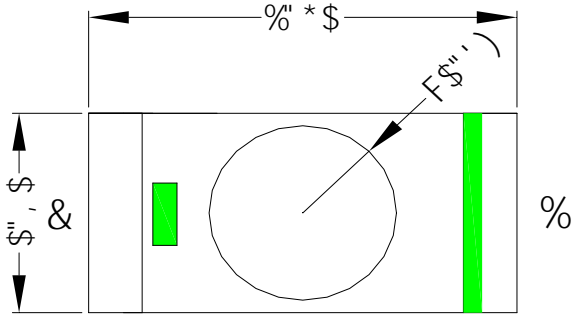

1.

2.

±

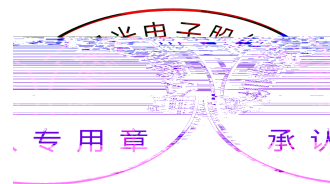

±0.2

							μ

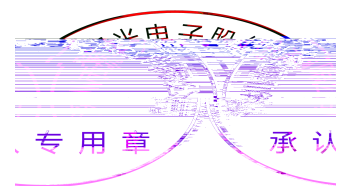

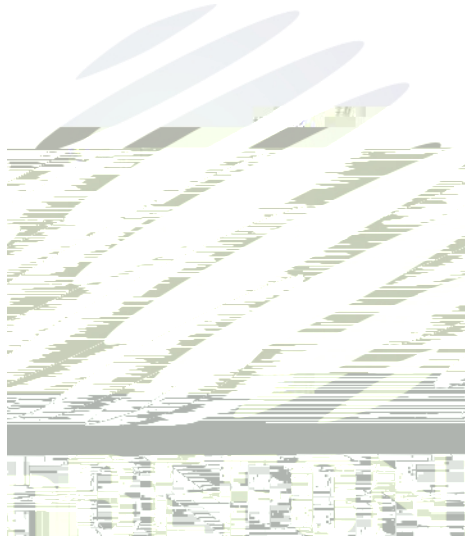

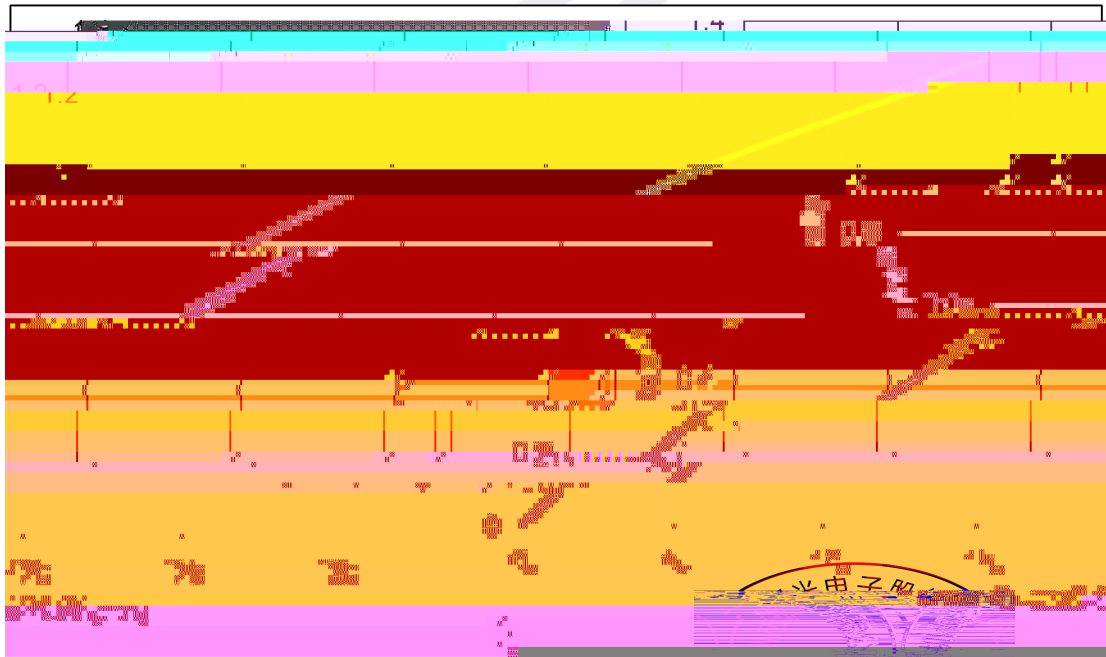
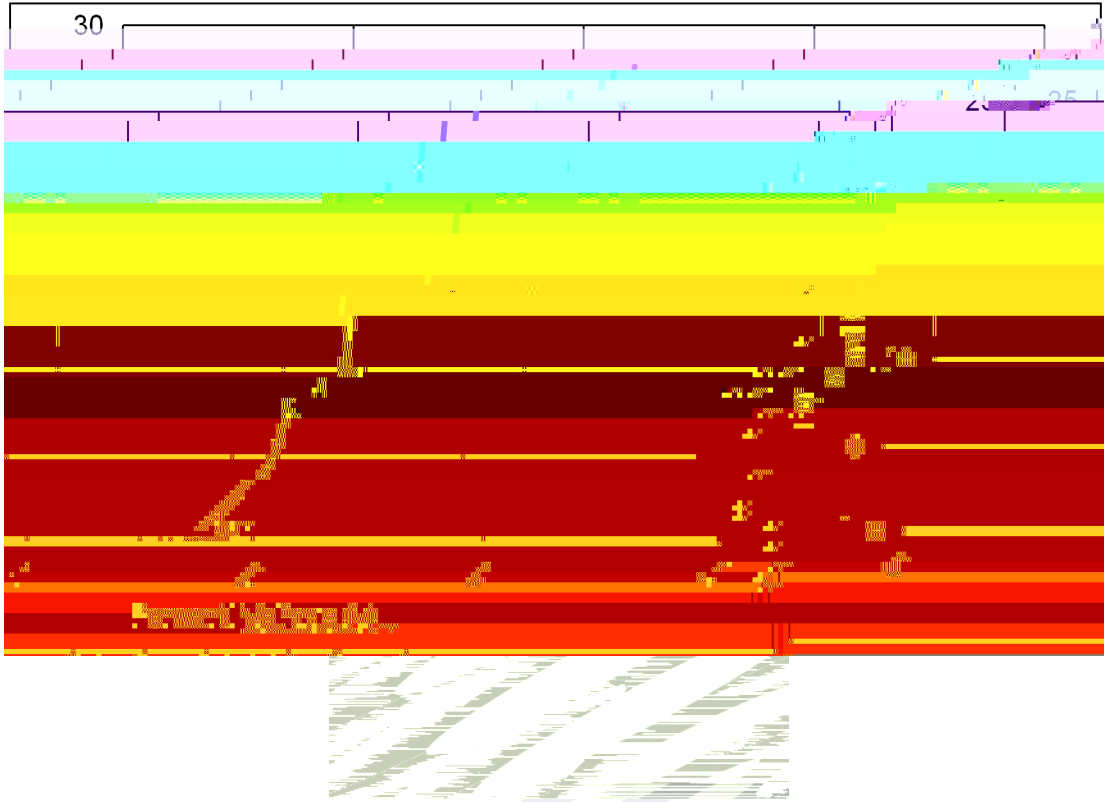

世通光电  
专用章 承认

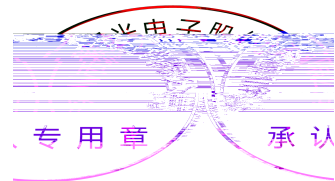
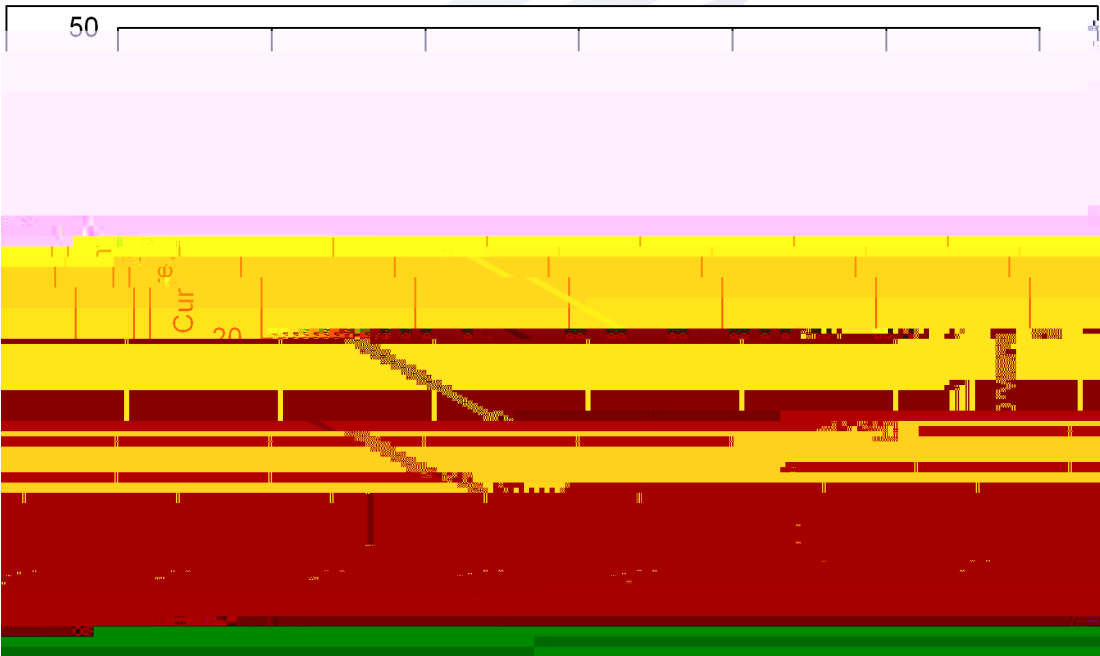
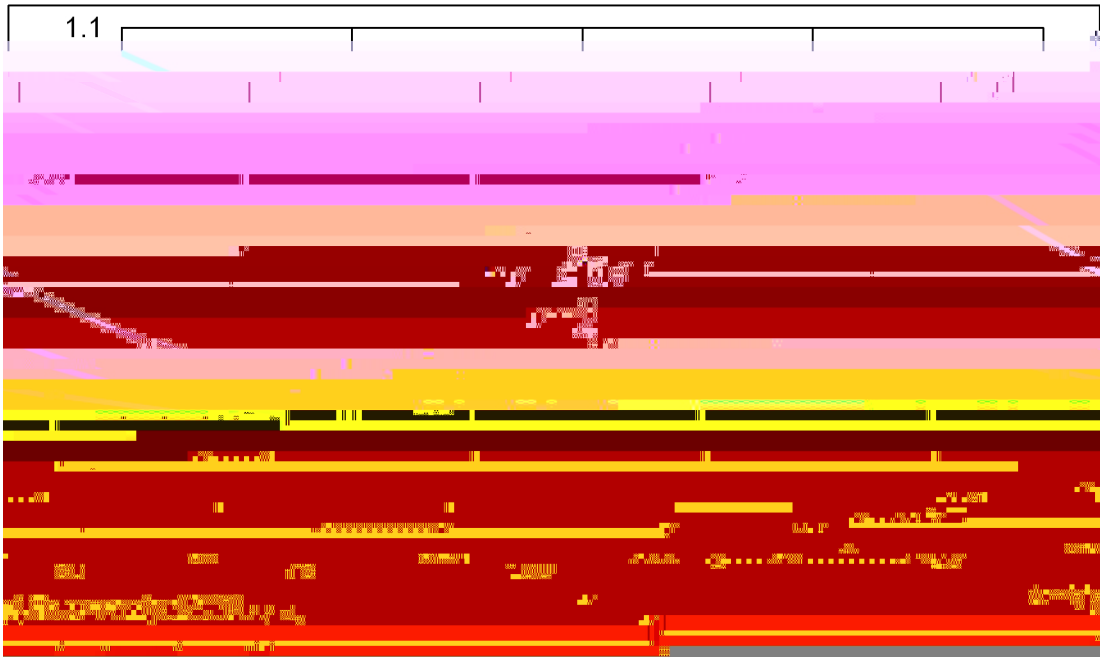



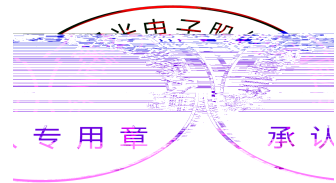
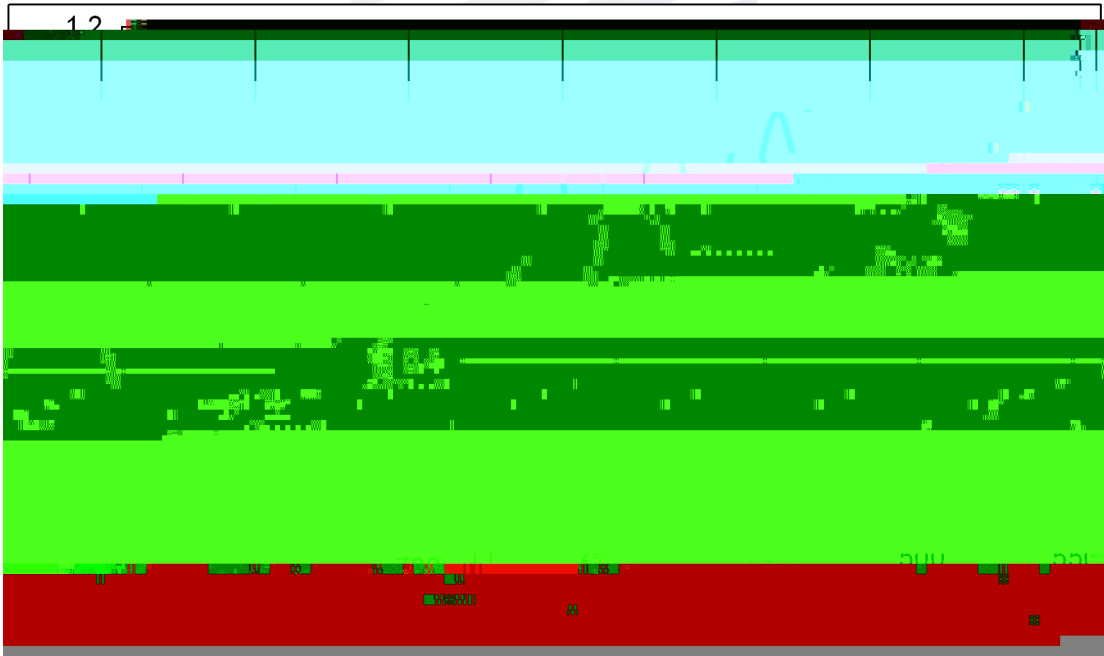
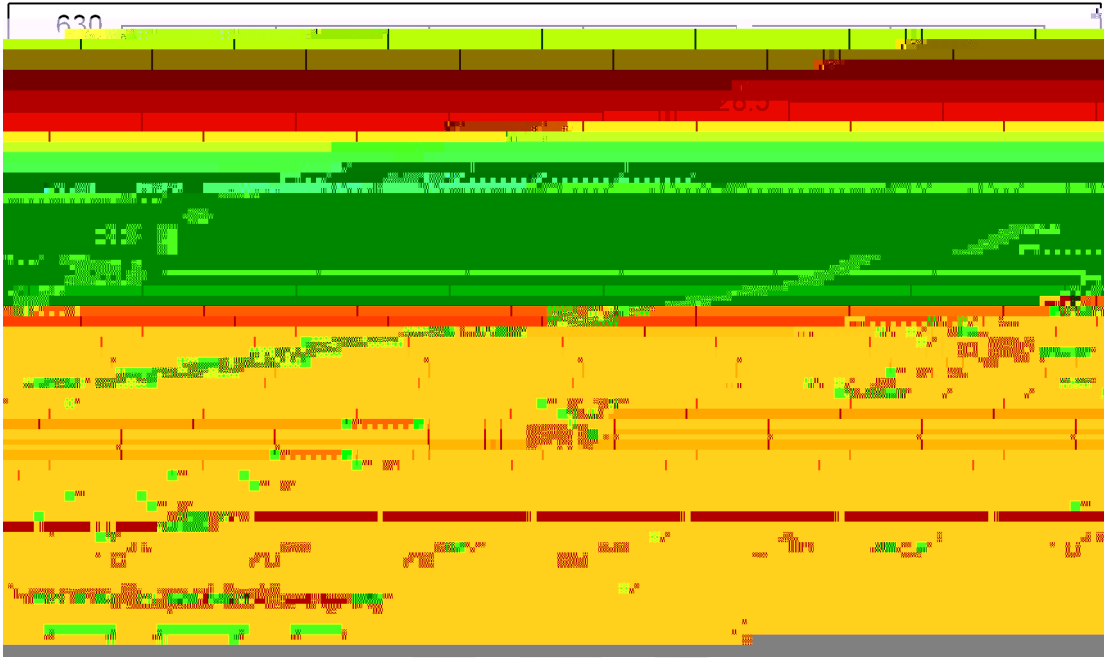

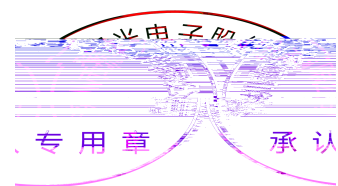
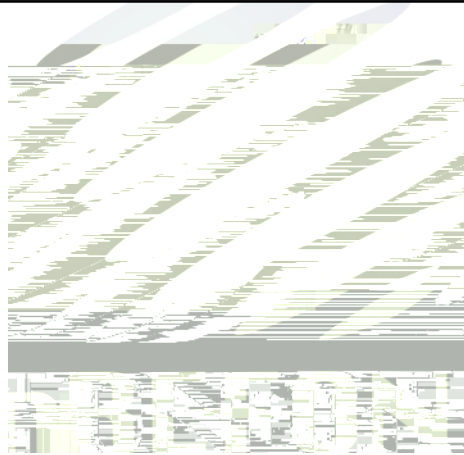
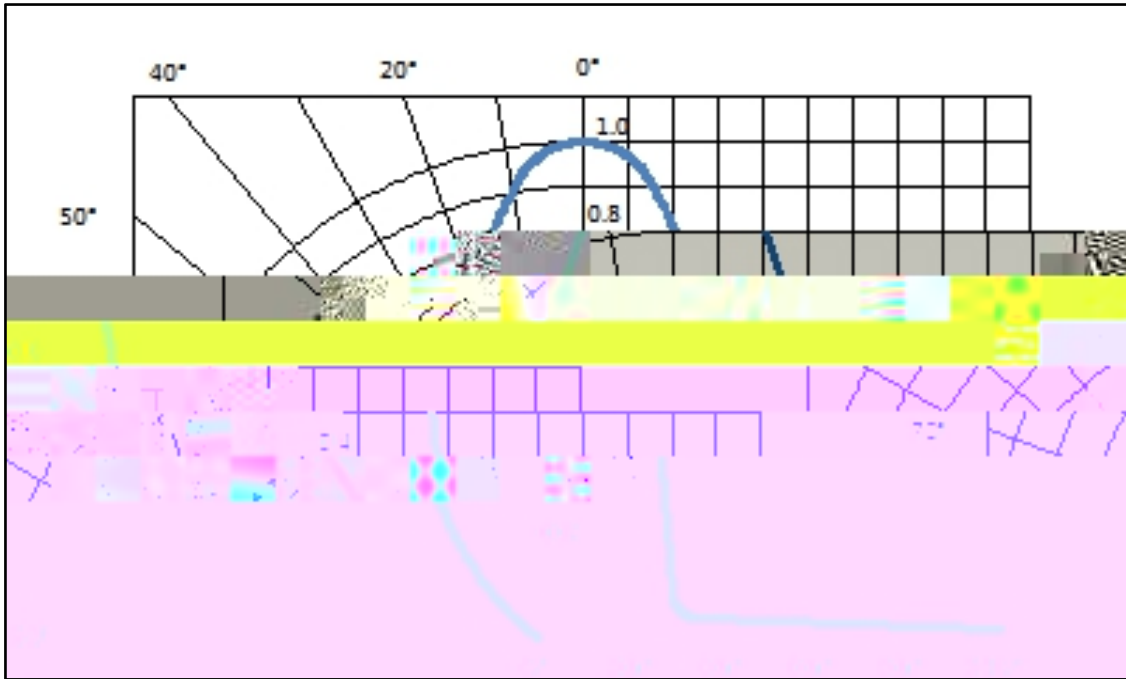

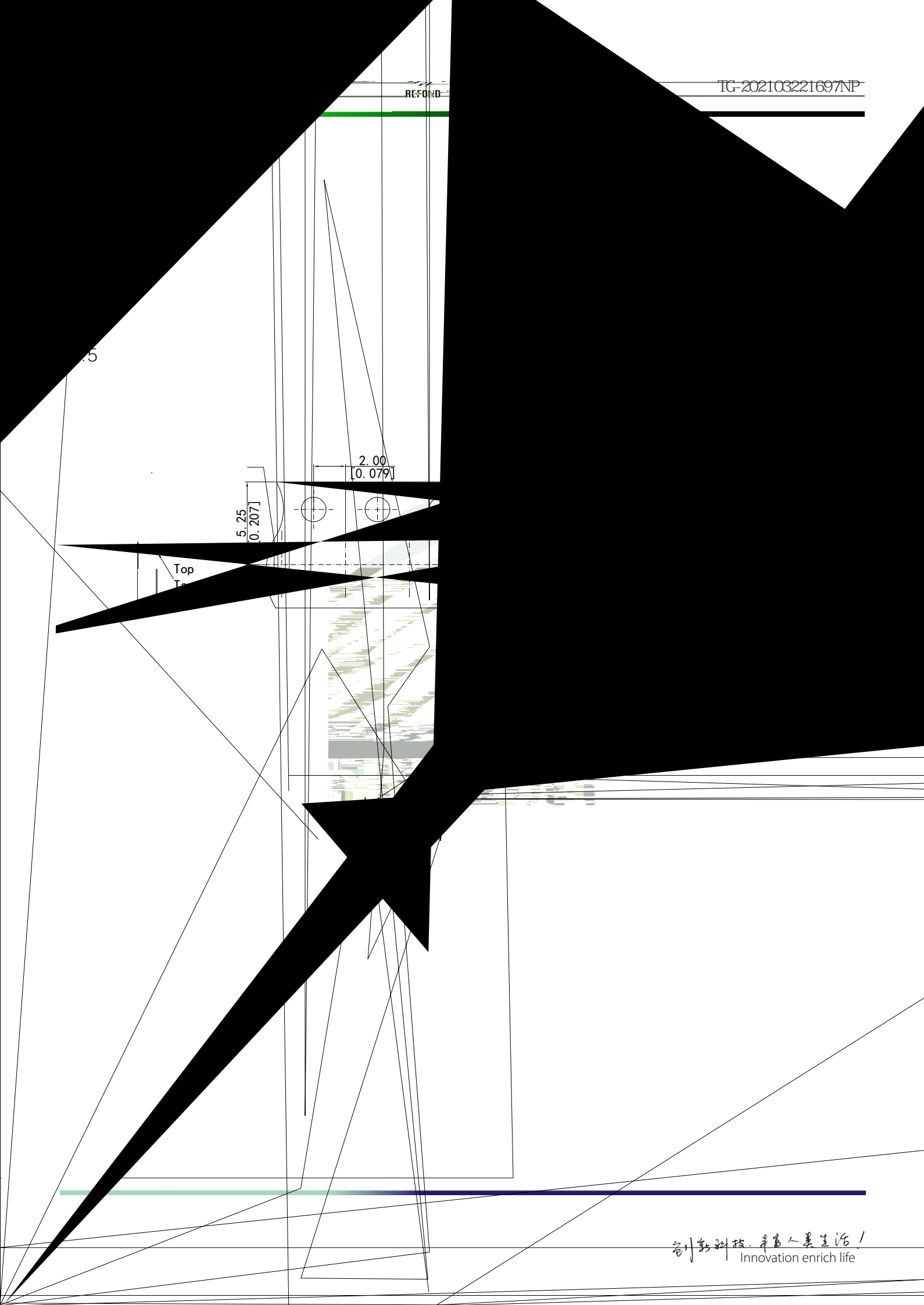



PART NO:  
SPEC NO:  
WLD:  
Qty:  
Date:

LOI NO:  
BIN CODE  
IV:  
VF:



---

---

---

---

---

---

---

---

---

---

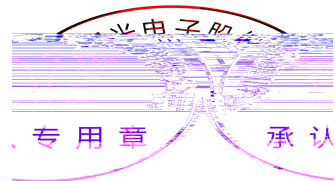
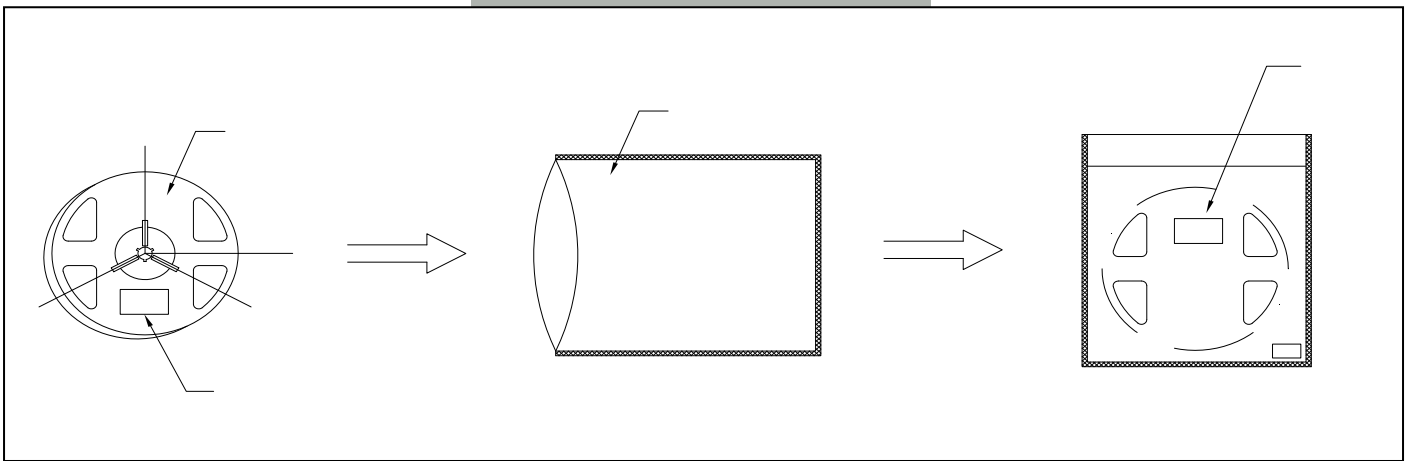
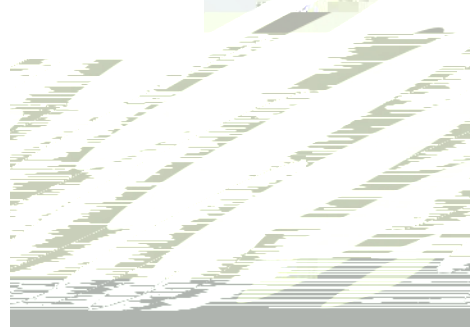

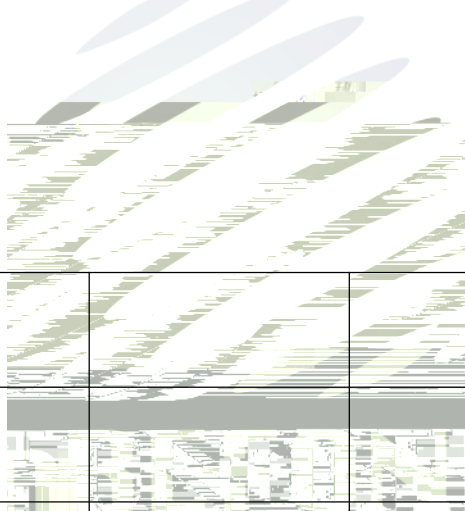
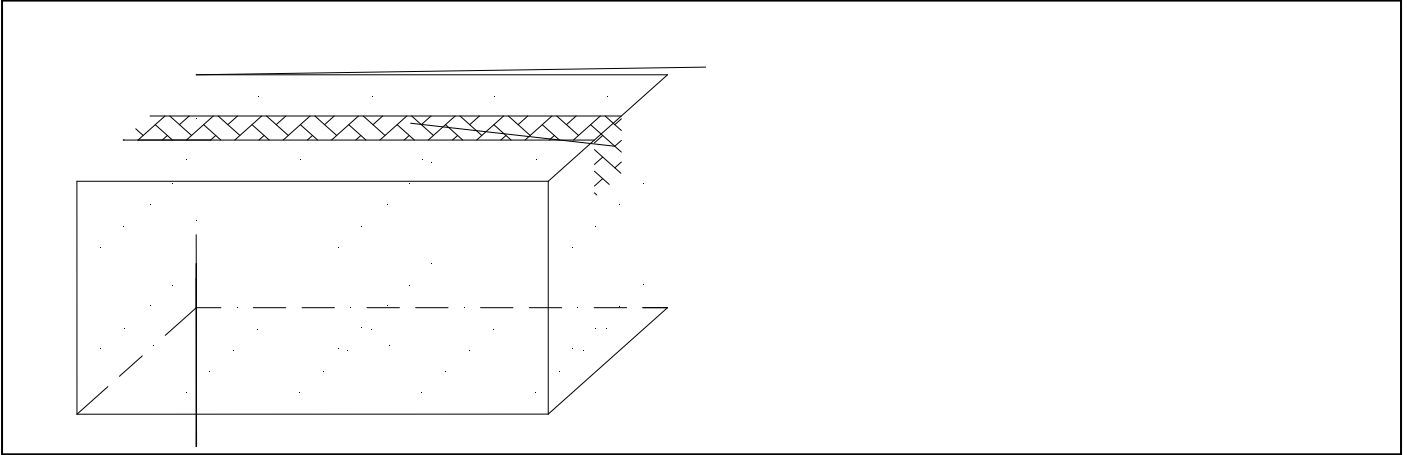



-X IQJ

[ 4000 ]

Y



G5'k'8& y

DĚ  
LED

/ LED

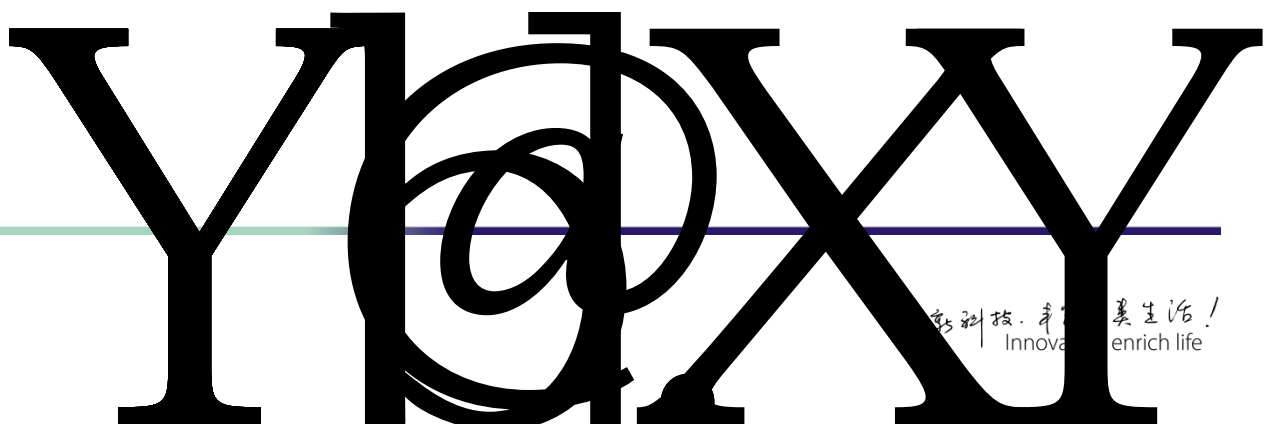



24 LED

" , 300 3

LED



PCB

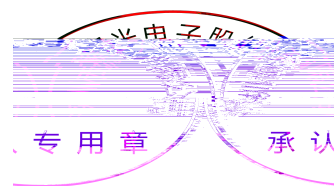



LED

100PPM.

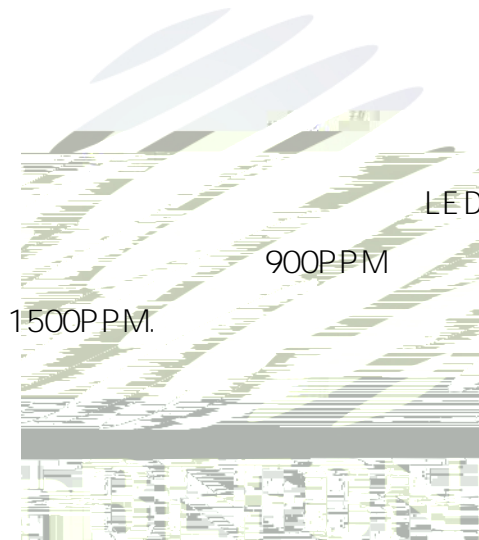

1500PPM.

900PPM

LED

LED

900PPM

LED

LED

LED

LED

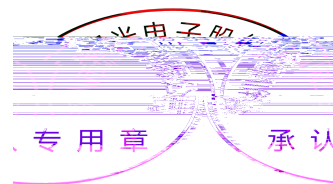



LED

LED

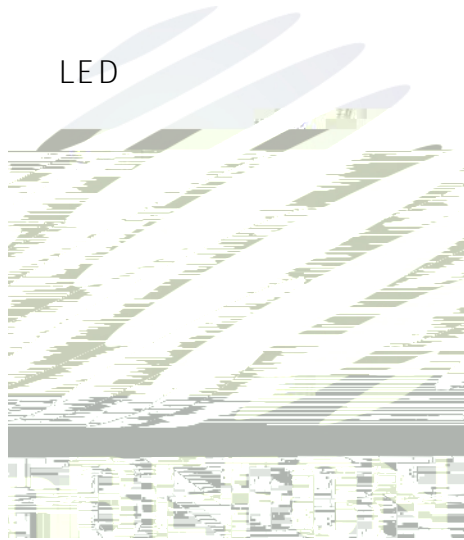

60±5

24

LED

