

±

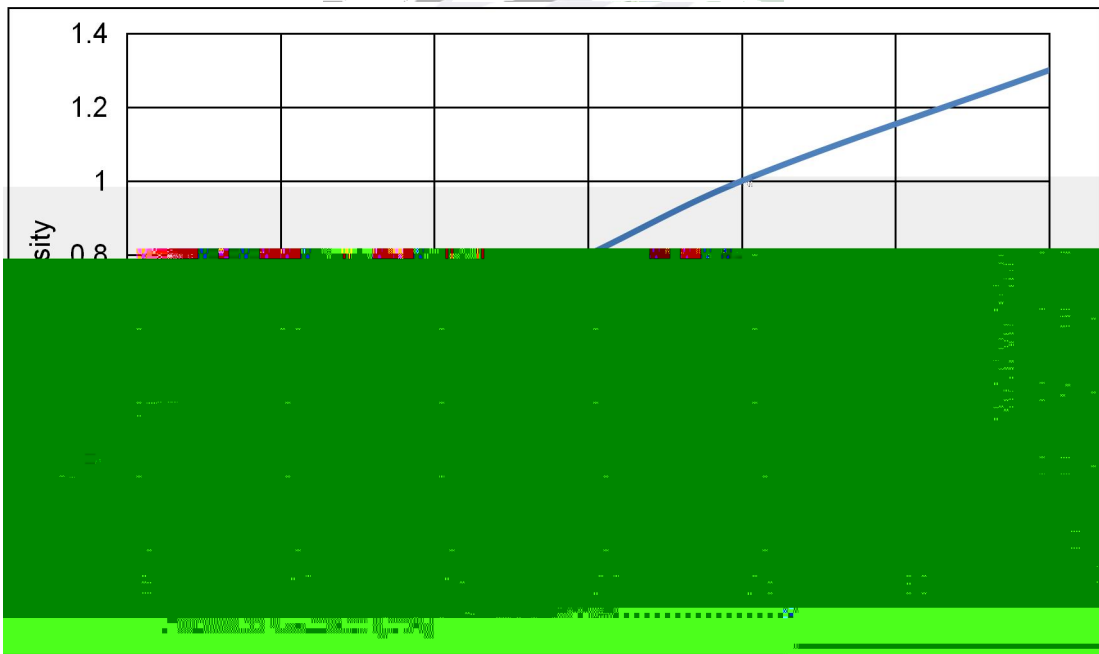

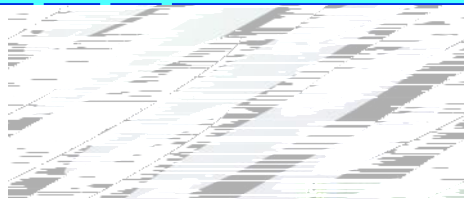

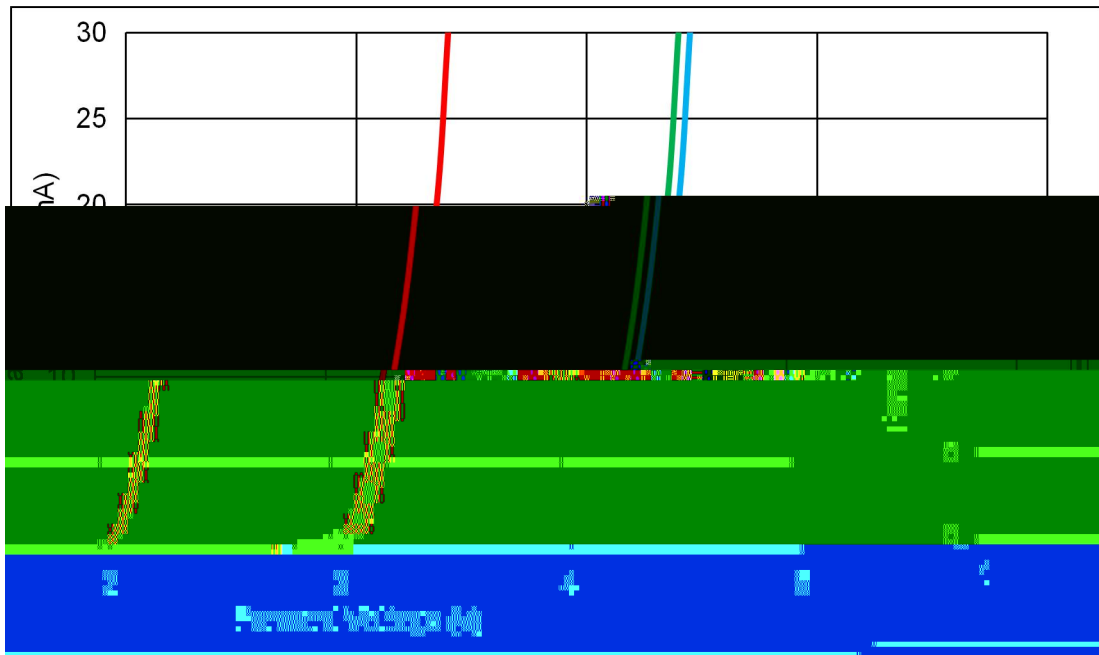

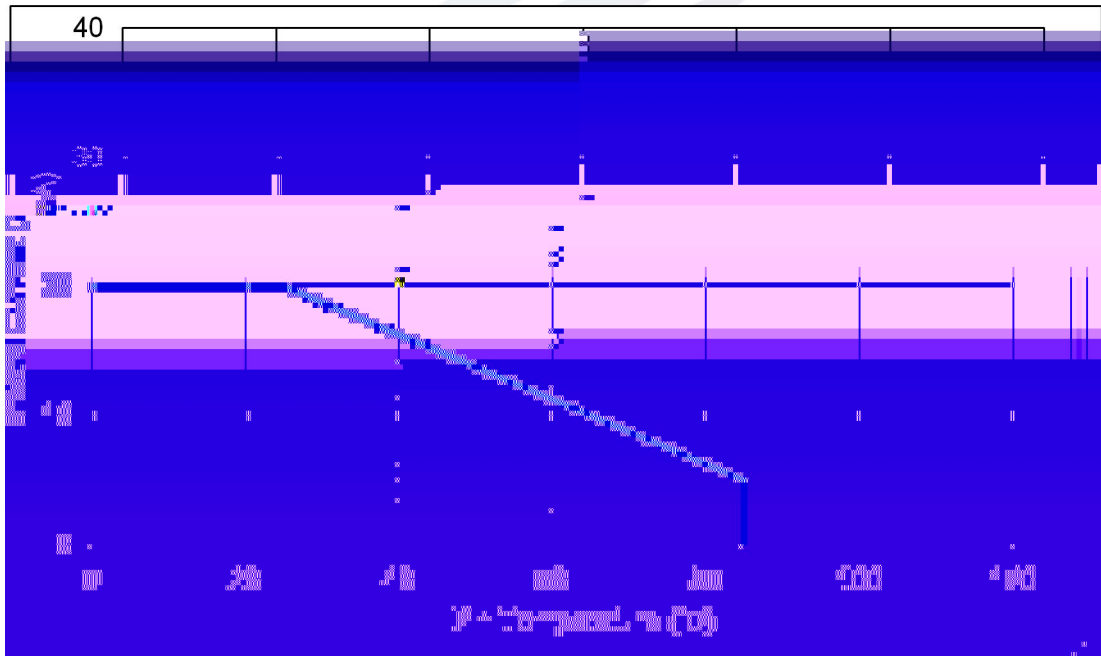
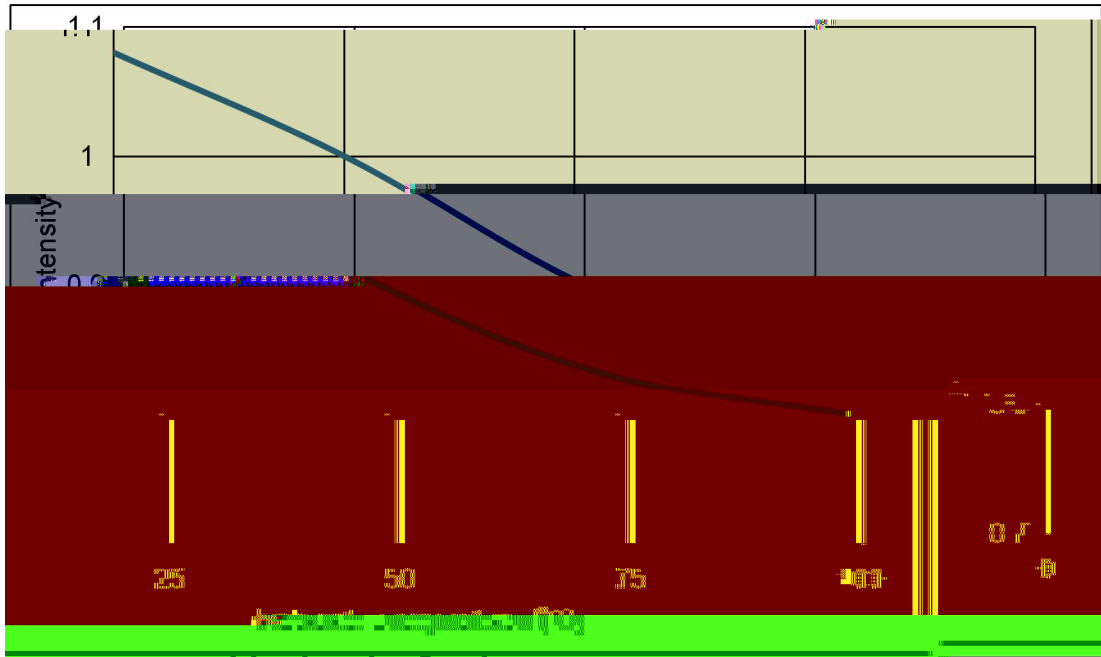
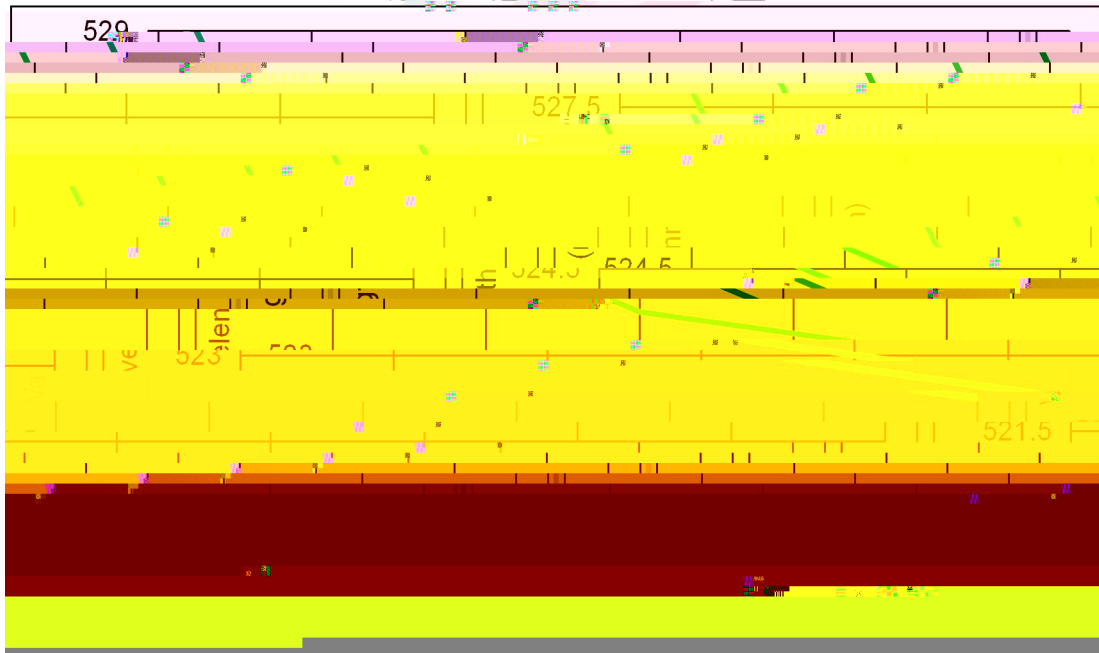
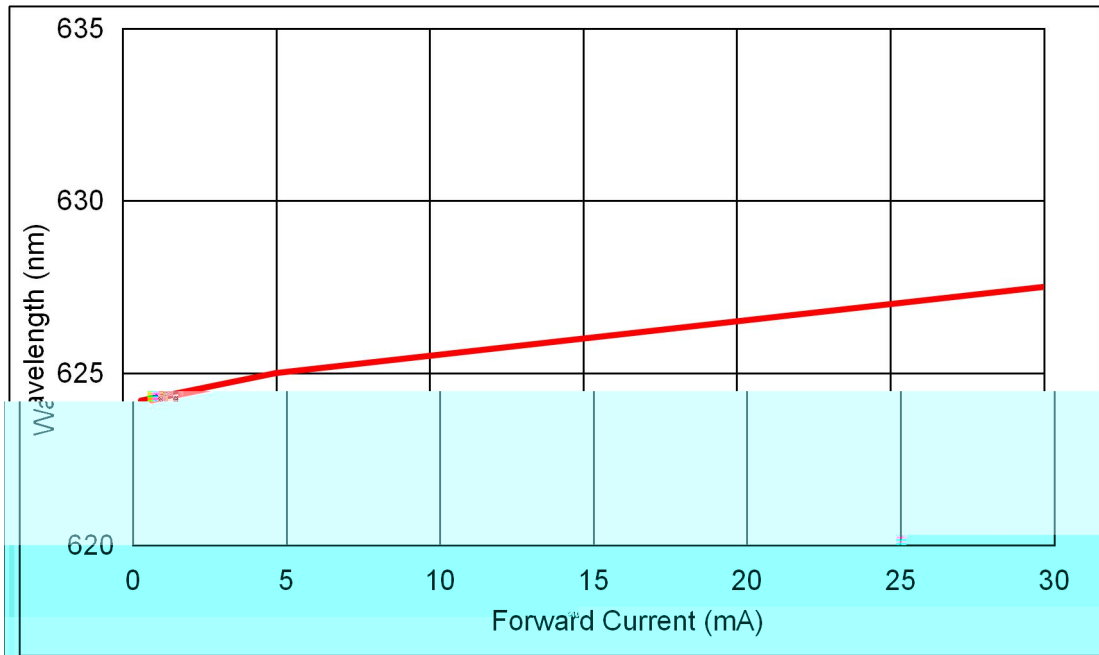

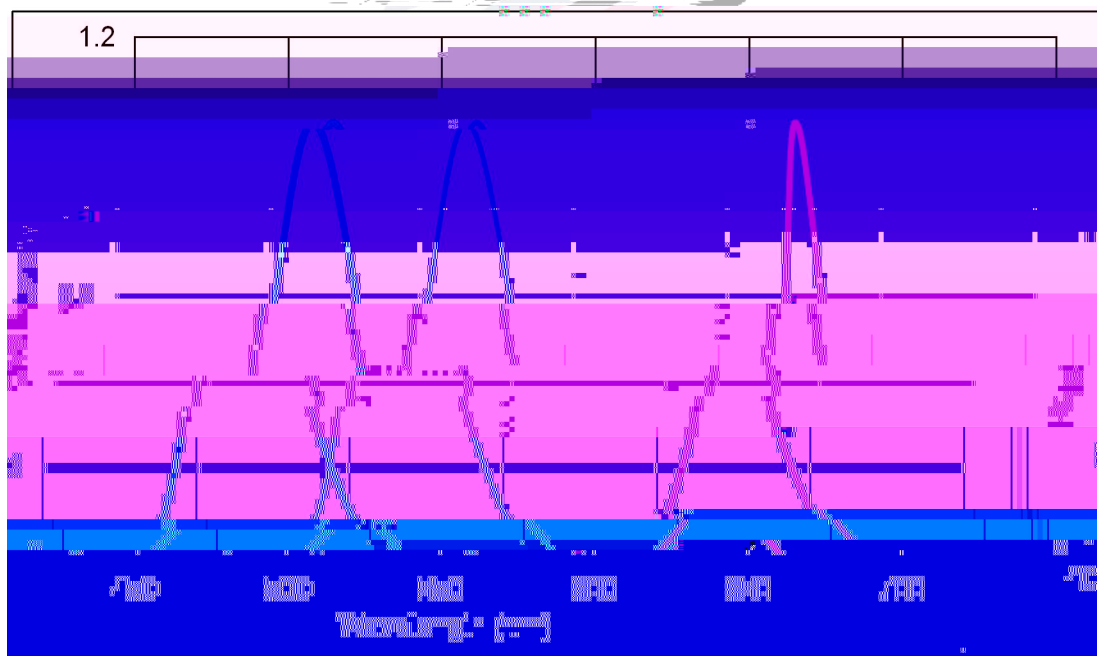
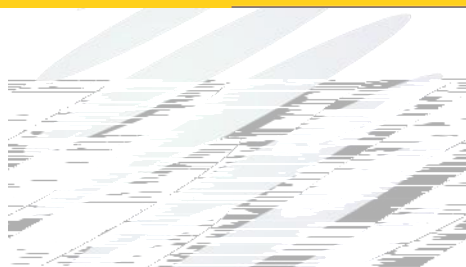

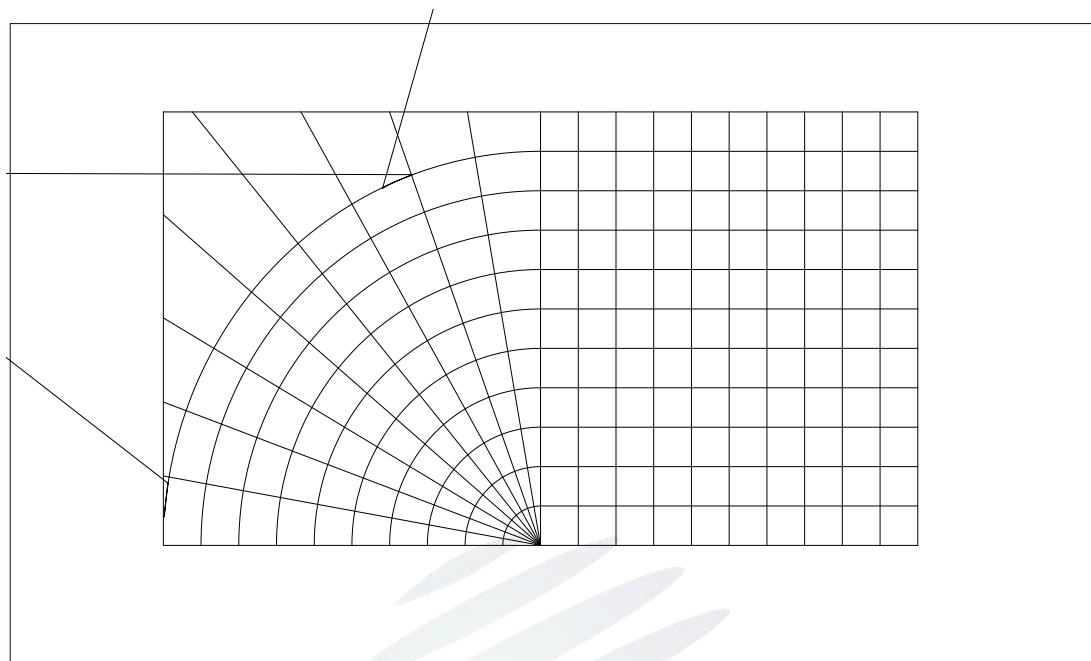



PART NO: .
SPEC NO:
LOT NO



BIN CODE:
Φ: XY:
VF: WLD:



QTY:
DATE:

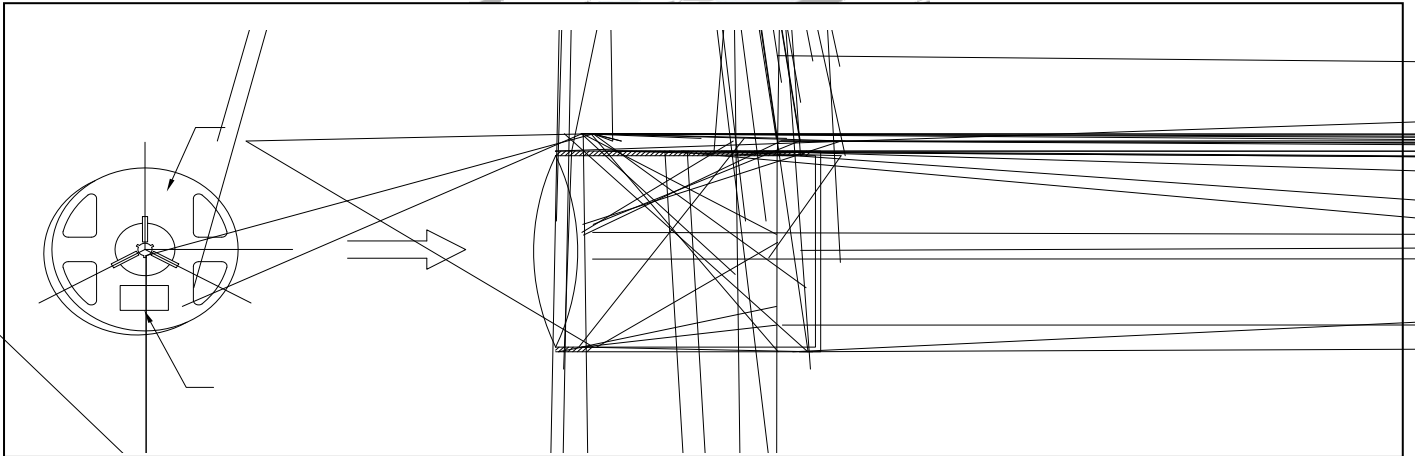
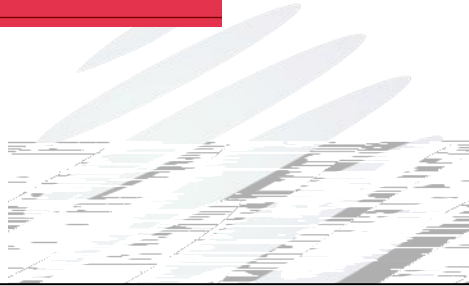

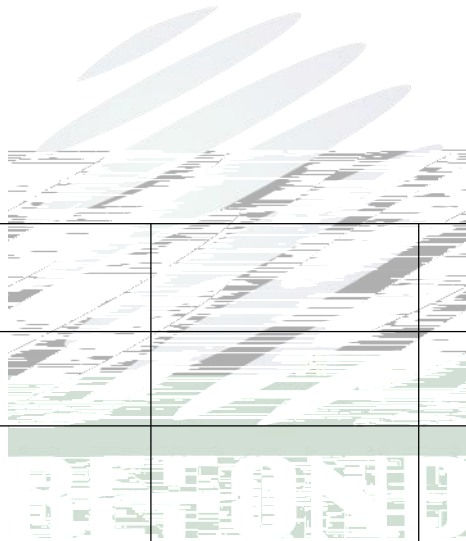
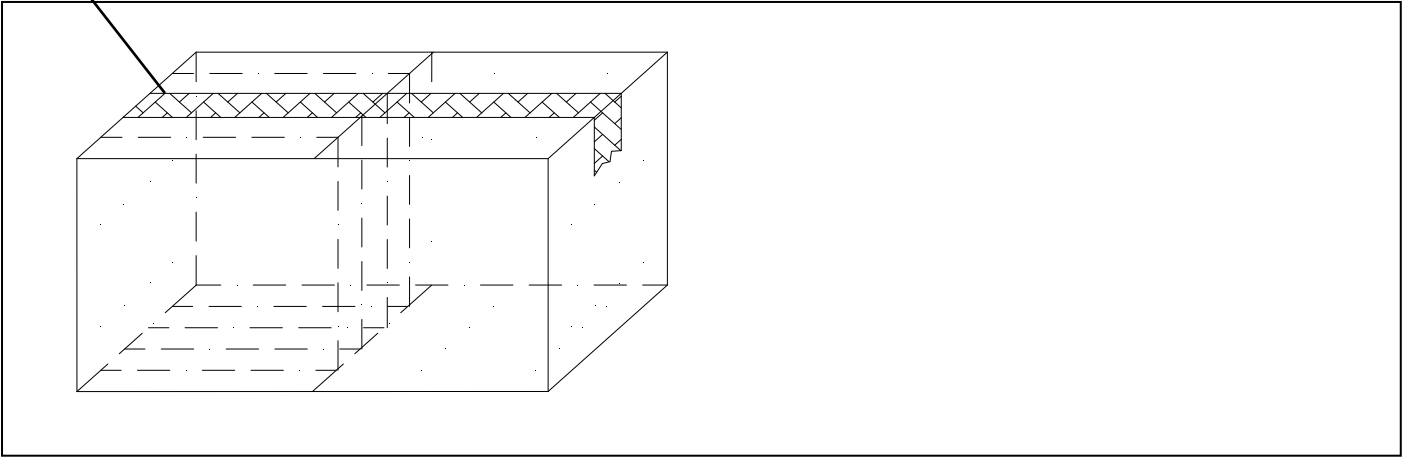

DE

+KED@

DFP

RU

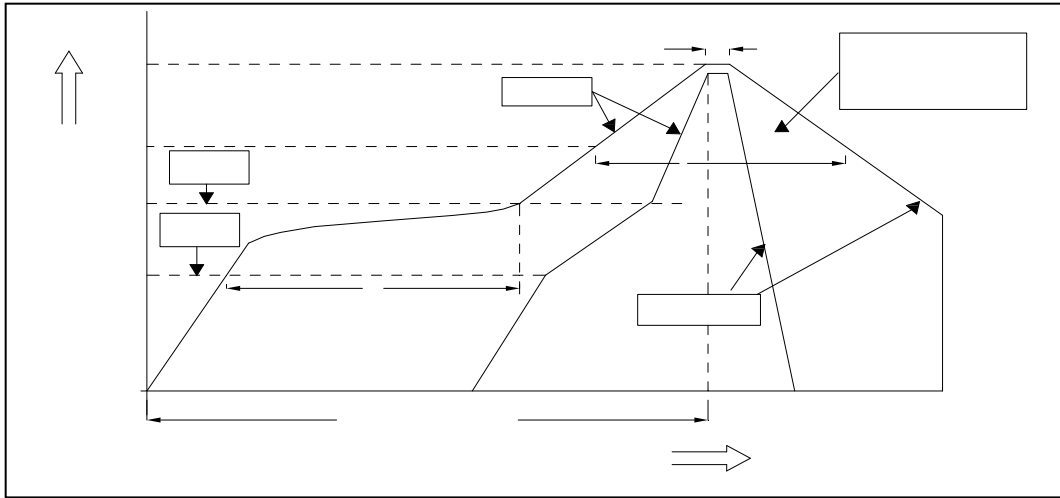

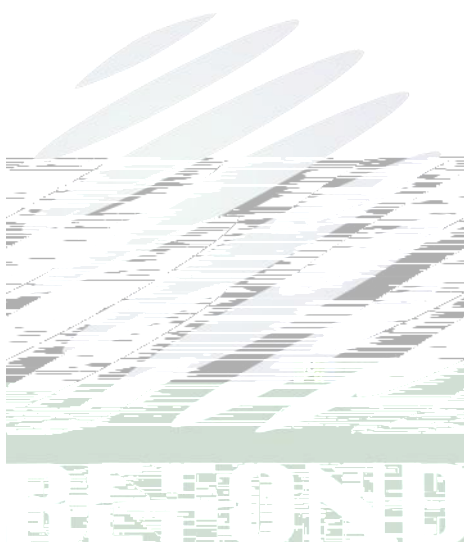

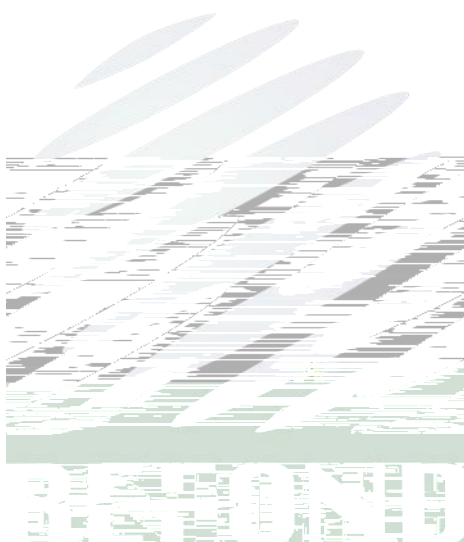

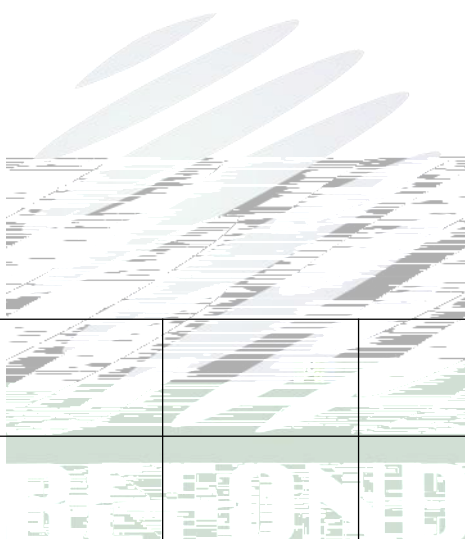

()

,

() °C



