



# SPECIFICATION



REFOND P/N

RF-WNS150DS-DD

R&D

Mass Product



# Contents

|  |     |
|--|-----|
| 1. Description   |     |
| 1.1 General Description                                      |     |
| 1.2 Features   |     |
| 1.3 Application  |     |
| 1.4 Package Dimension  |     |
| 1.5 Product Parameters                                       |     |
| 1.6 Bin Range Of Forward Voltage and Luminous Flux (IF=20mA) | BIN |
| (IF=20mA)  |     |
| 1.7 Typical Optical Characteristics Curves                   |     |
| 2. Packaging   |     |
| 2.1 Packaging Specification                                  |     |
| 2.1.1 Carrier Tape Dimension                                 | 12  |
| 2.1.2 Reel Dimension   | 12  |
| 2.1.3 Label Form Specification                               | 13  |
| 2.2 Moisture Resistant Packing                               |     |
| 2.3 Cardboard Box  |     |
| 2.4 Reliability Test Items And Conditions                    |     |
| 2.5 Criteria For Judging Damage                              |     |
| 3. SMT Reflow Soldering Instructions SMT                     |     |
| 3.1 SMT Reflow Soldering Instructions SMT                    |     |

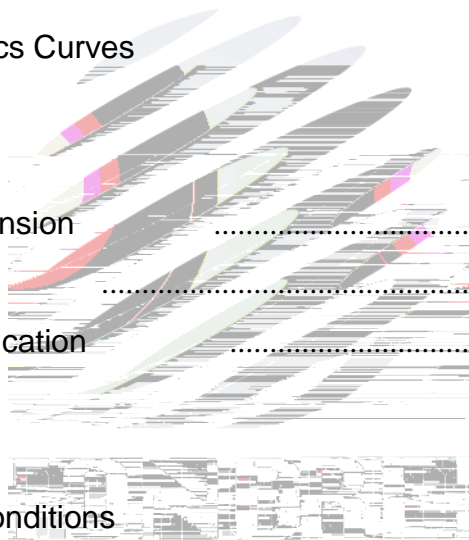

# 1. Description

## 1.1 General Description

The White LED, which was fabricated by using a blue chip and the phosphor.

Product Package: 3.2mmX1.6mmX0.7mm.

LED

3.2mmX1.6mmX0.7mm

## 1.2 Features

Extremely wide viewing angle.

Suitable for all SMT assembly and solder process.

Moisture sensitivity level: Level 3.

RoHS compliant.

RoHS

Level 3

SMT

## 1.3 Application

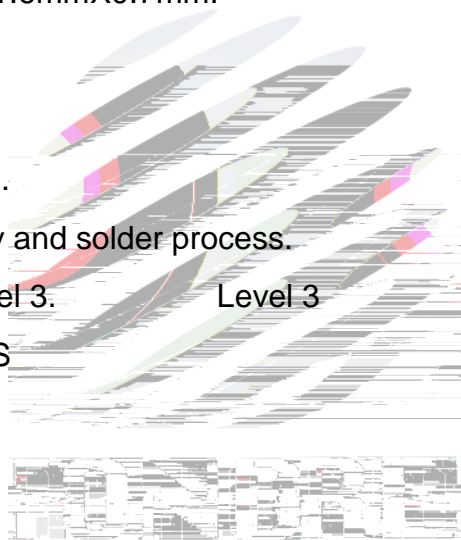

### 1.4 Package Dimension

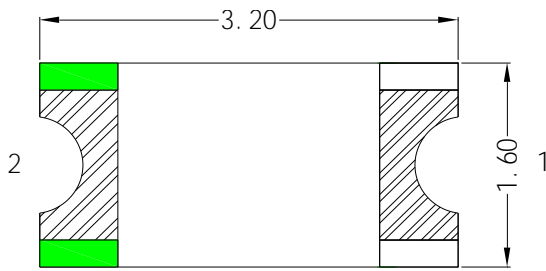

Fig.1-1 Top view

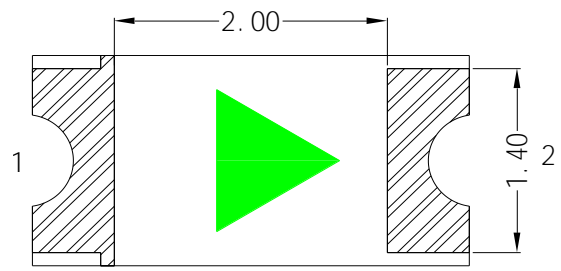

Fig.1-2 Bottom view

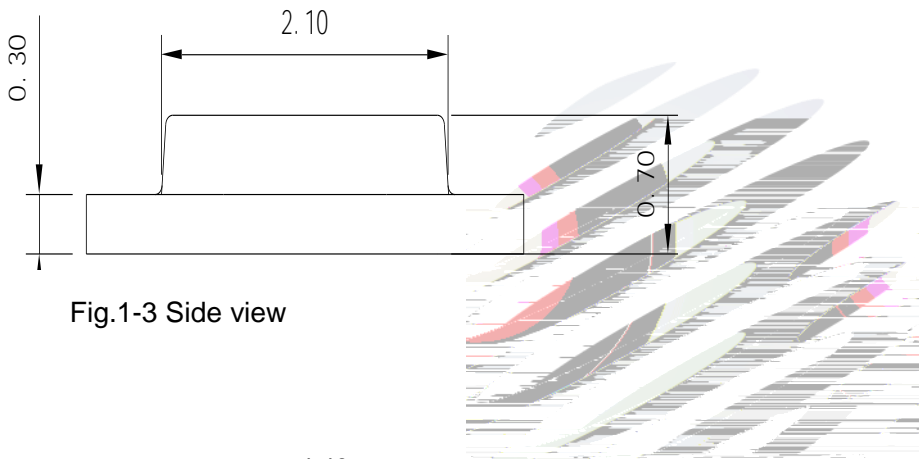

Fig.1-3 Side view

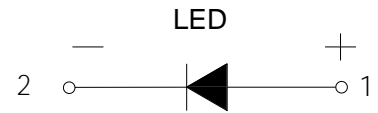

Fig.1-4 Polarity

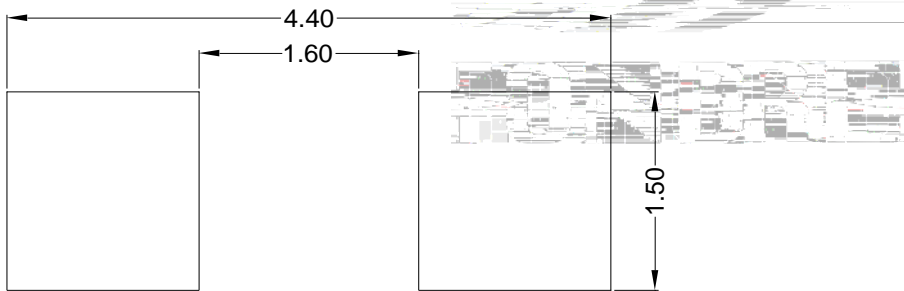
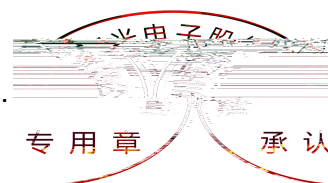

Fig.1-5 Soldering patterns

#### Notes

1. All dimensions units are millimeters.
2. All dimensions tolerances are  $\pm 0.2$ mm unless otherwise noted.



$\pm 0.2$

## 1.5 Product Parameters

Table 1-1 Electrical / Optical Characteristics at Ts=25°C

| Item            | Test Condition       | Symbol         |     | Value |             |             | Unit |
|-----------------|----------------------|----------------|-----|-------|-------------|-------------|------|
|                 |                      |                |     | Min.  | Typ.<br>( ) | Max.<br>( ) |      |
| Forward Voltage | I <sub>F</sub> =20mA | V <sub>F</sub> | G1  | 2.8   | --          | 2.9         | V    |
|                 |                      |                | G2  | 2.9   | --          | 3.0         | V    |
|                 |                      |                | H1  | 3.0   | --          | 3.1         | V    |
|                 |                      |                | H2  | 3.1   | --          | 3.2         | V    |
|                 |                      |                | I1  | 3.2   | --          | 3.3         | V    |
|                 |                      |                | I2  | 3.3   | --          | 3.4         | V    |
|                 |                      |                | J1  | 3.4   | --          | 3.5         | V    |
|                 |                      |                | 1BB | 400   | --          | 450         | mcd  |
|                 |                      |                | 1BC | 450   | --          | 500         | mcd  |
|                 |                      |                | 1BD | 500   | --          | 550         | mcd  |
|                 |                      |                | 1BE | 550   | --          | 600         | mcd  |

Table 1-2 Absolute Maximum Ratings at Ts=25°C

Notes

1. 1/10 Duty cycle, 0.1ms pulse width.

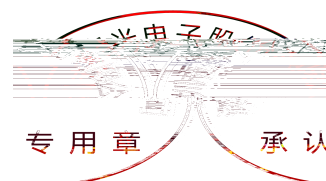
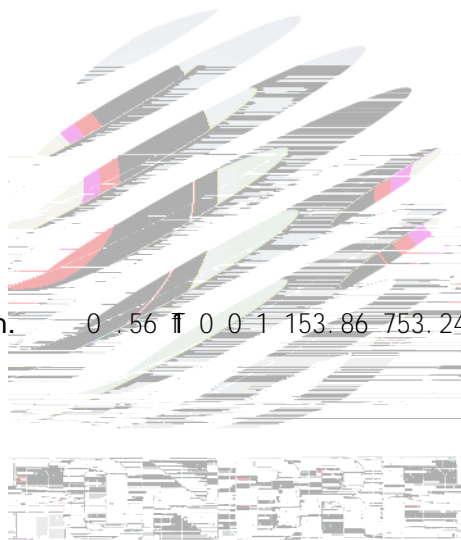

## 1.6 Bin Range Of Forward Voltage and Luminous Flux (IF=20mA)

### BIN (IF=20mA)

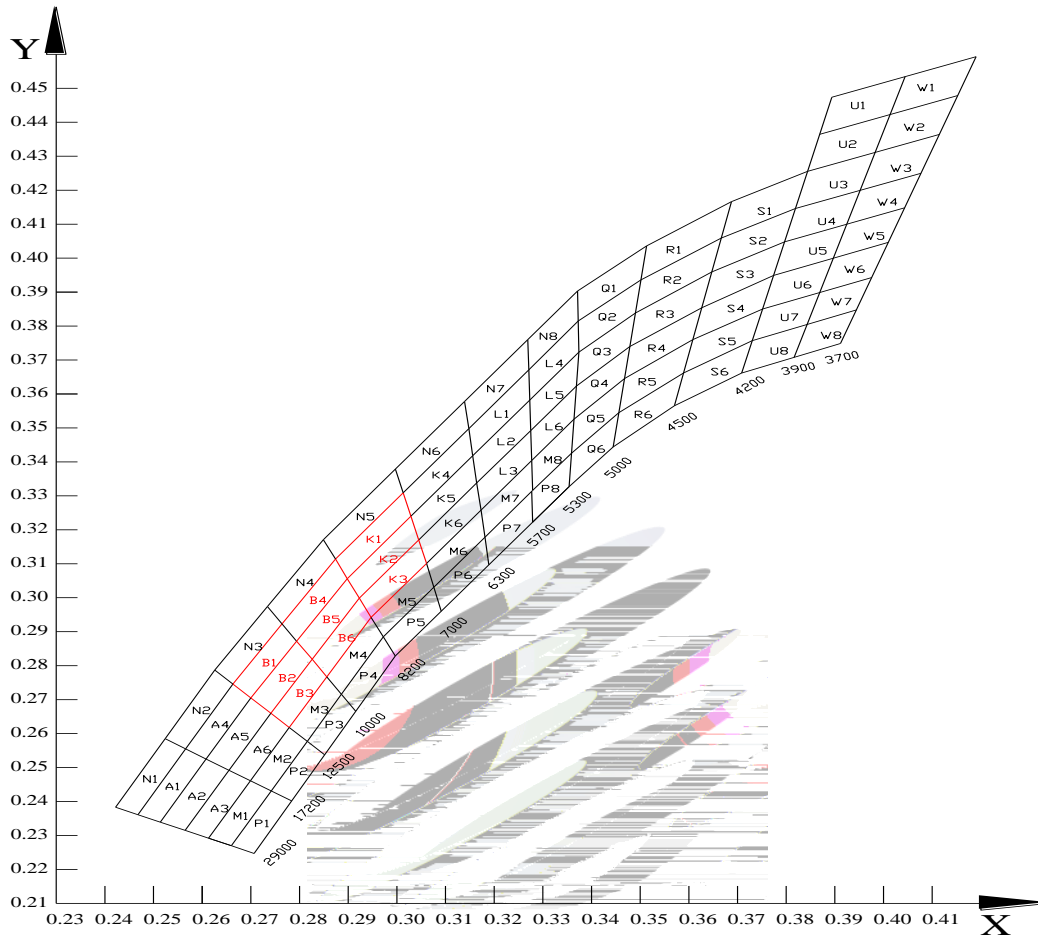

Fig. 1-6 The C.I.E Chromaticity Diagram CIE

Table 1-3 Bin Date Bin

| BIN CODE | CIE-X1 | CIE-Y1 | CIE-X2 | CIE-Y2 | CIE-X3 | CIE-Y3 | CIE-X4 | CIE-Y4 |
|----------|--------|--------|--------|--------|--------|--------|--------|--------|
| B01      | 0.2700 | 0.2705 | 0.2663 | 0.2746 | 0.2764 | 0.2923 | 0.2794 | 0.2872 |
| B02      | 0.2741 | 0.2660 | 0.2700 | 0.2705 | 0.2794 | 0.2872 | 0.2826 | 0.2819 |
| B03      | 0.2779 | 0.2618 | 0.2741 | 0.2660 | 0.2826 | 0.2819 | 0.2856 | 0.2767 |
| B04      | 0.2794 | 0.2872 | 0.2764 | 0.2923 | 0.2874 | 0.3114 | 0.2898 | 0.3056 |
| B05      | 0.2826 | 0.2819 | 0.2794 | 0.2872 | 0.2898 | 0.3056 | 0.2923 | 0.2999 |
| B06      | 0.2856 | 0.2767 | 0.2826 | 0.2819 | 0.2923 | 0.2999 | 0.2947 | 0.2942 |
| K01      | 0.2898 | 0.3056 | 0.2874 | 0.3114 | 0.3013 | 0.3309 | 0.3029 | 0.3240 |
| K02      | 0.2923 | 0.2999 | 0.2898 | 0.3056 | 0.3029 | 0.3240 | 0.3045 | 0.3170 |
| K03      | 0.2947 | 0.2942 | 0.2923 | 0.2999 | 0.3045 | 0.3170 | 0.3061 | 0.3101 |

## 1.7 Typical Optical Characteristics Curves

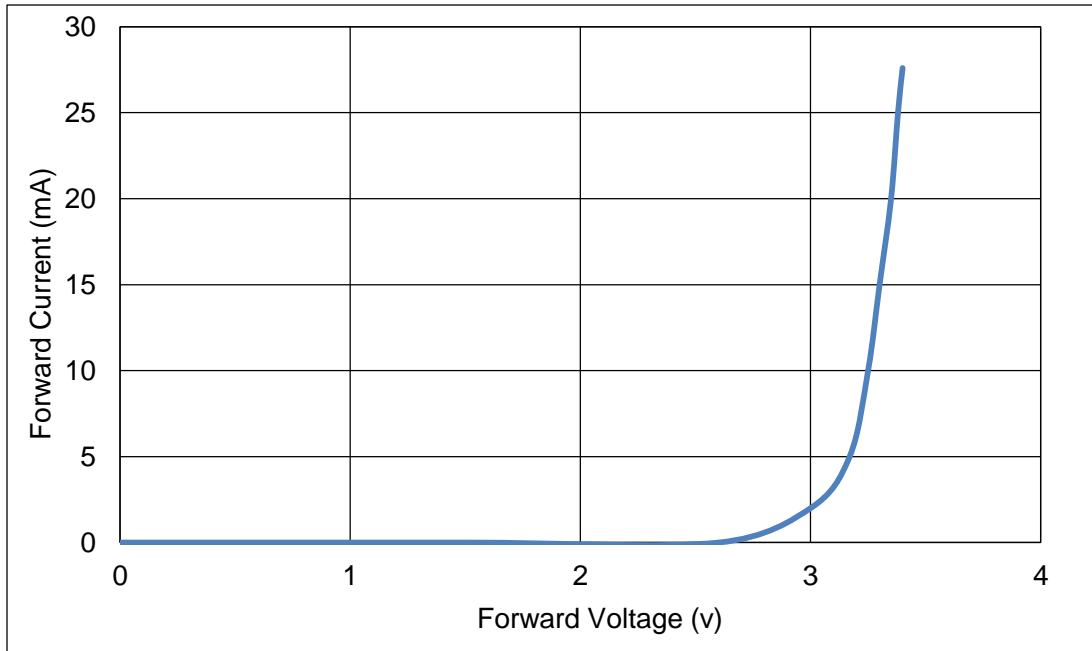

Fig 1-7 Forward Voltage Vs Forward Current

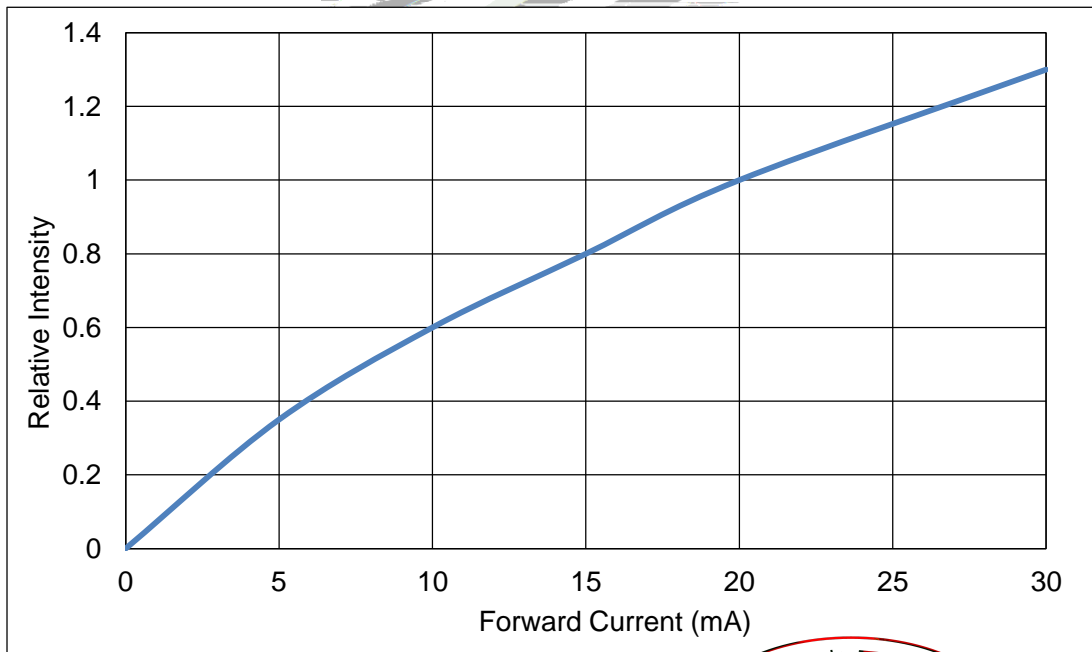

Fig 1-8 Forward Current Vs Relative Intensity

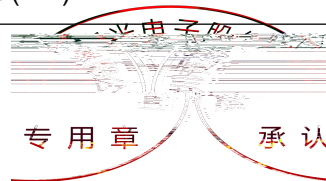



Fig 1-9 Pin Temperature Vs Relative Intensity

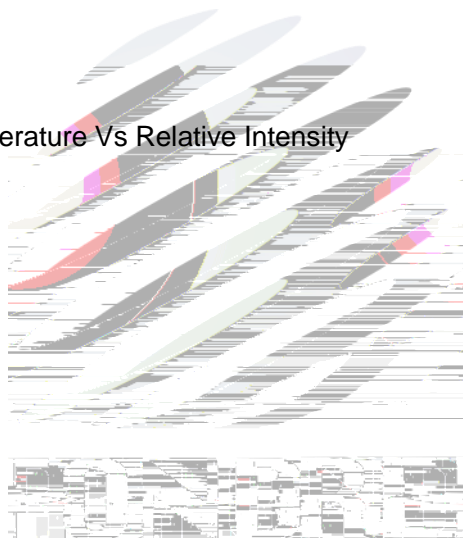
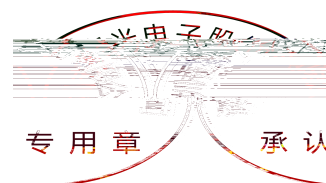

Fig 1-10 Pin Temperature Vs



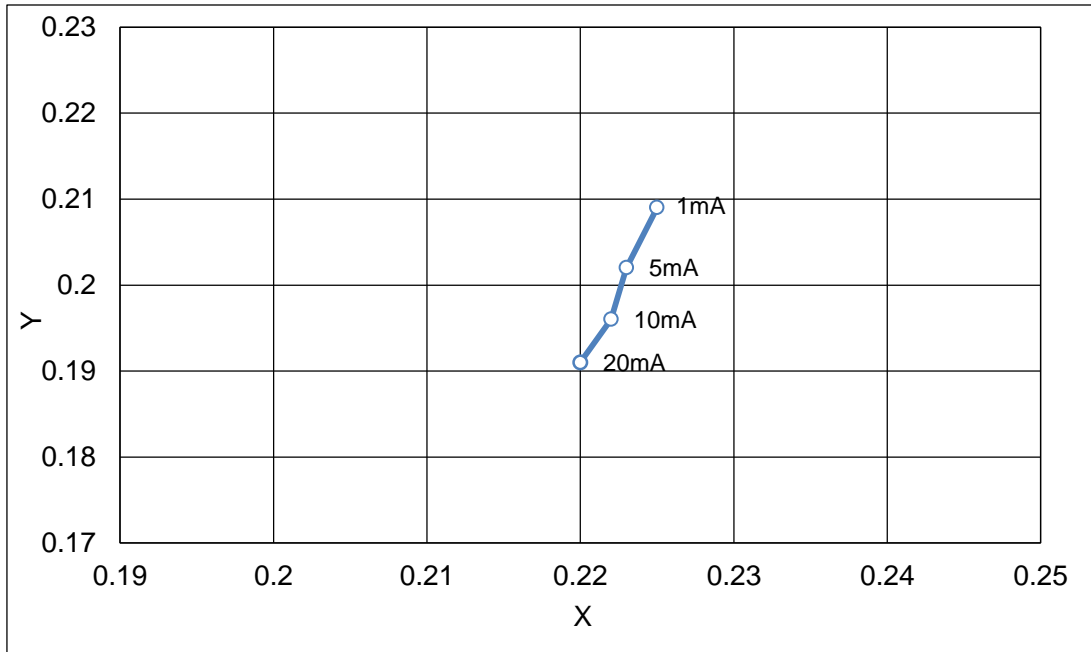

Fig.1-11 Forward Current Vs Dominate Wavelength (Ta=25°C)

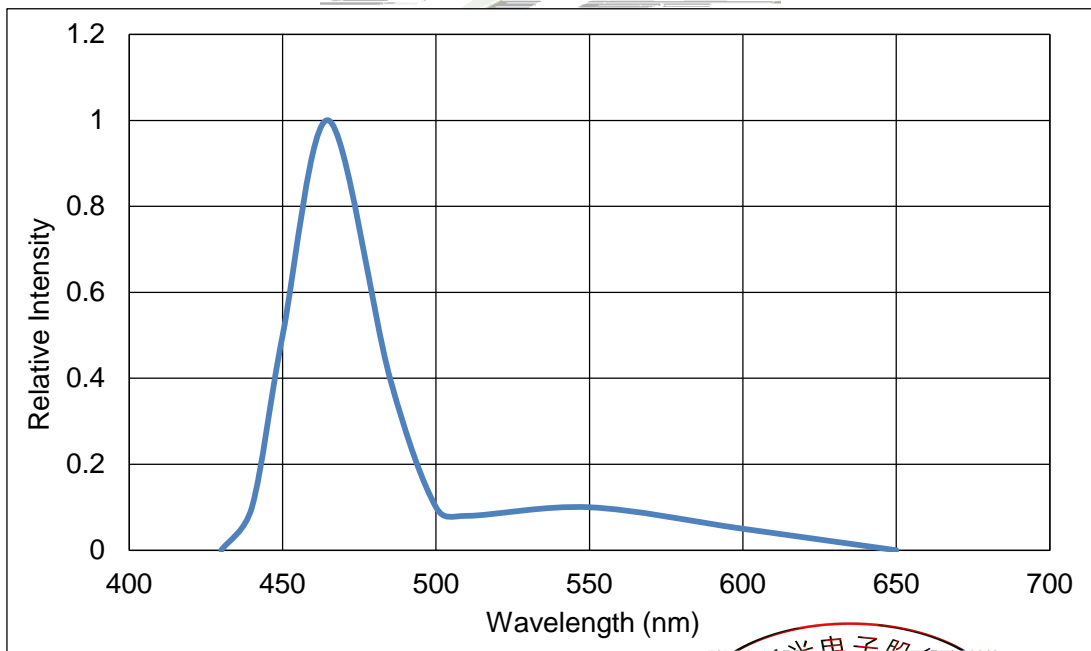
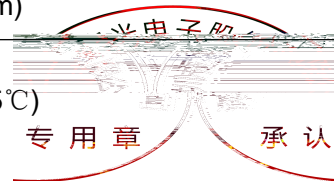

Fig.1-12 Relative Intensity Vs Wavelength (Ta=25°C)



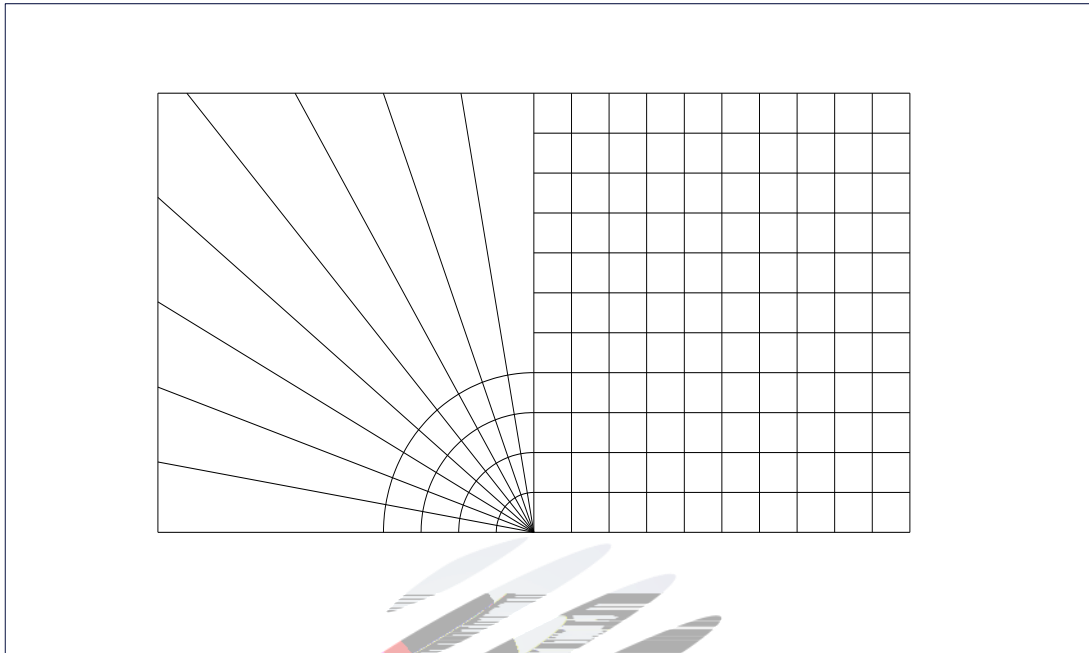
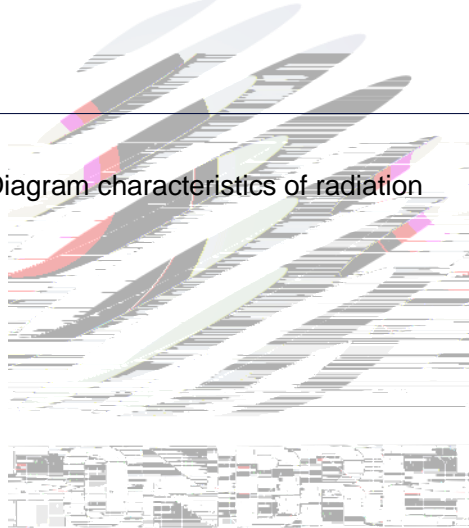

Fig.1-13 Diagram characteristics of radiation



## 2. Packaging

### 2.1 Packaging Specification

Package:4000pcs/reel.

4000pcs

#### 2.1.1 Carrier Tape Dimension

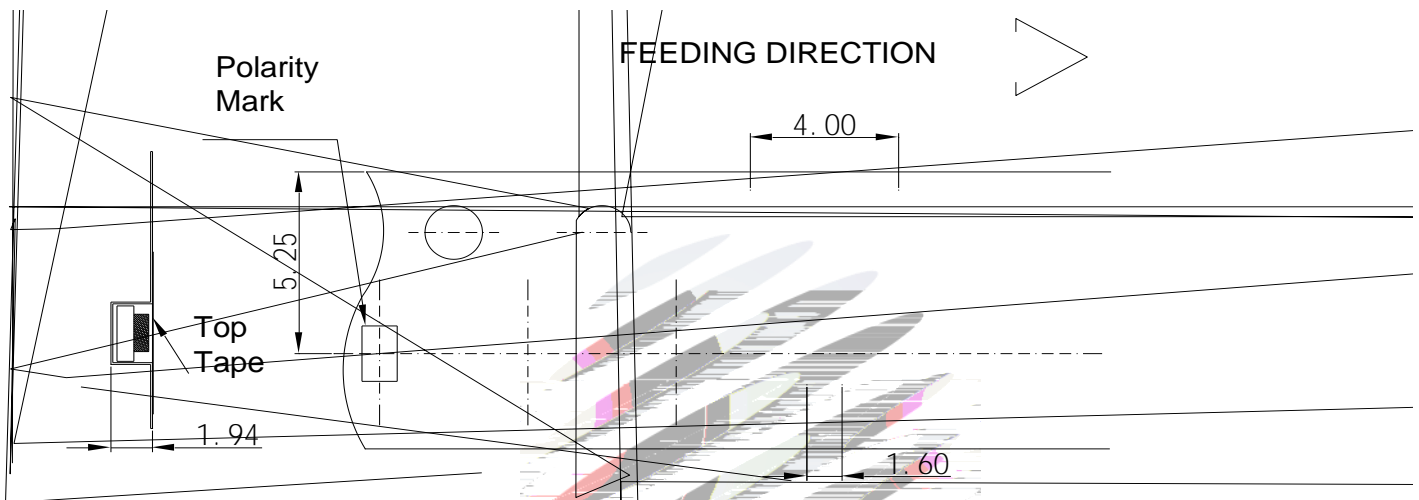
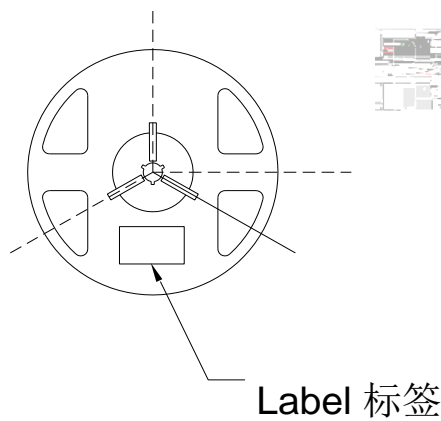

Fig.2-1 Carrier Tape Dimension

#### 2.1.2 Reel Dimension



Label 标签

Fig.2-2 Reel Dimension

Table 2-1 Dimension

|   |             |
|---|-------------|
| A | 8.0± 0.1mm  |
| B | 178± 1mm    |
| C | 60± 1mm     |
| D | 13.0± 0.5mm |

#### Notes

The tolerances unless mentioned  $\pm 0.1\text{mm}$ . Unit : mm

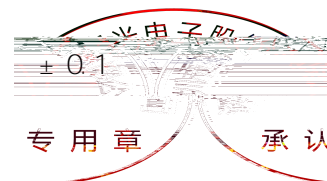

### 2.1.3 Label Form Specification

Table 2-2 Parameter

|          |             |
|----------|-------------|
| PART NO. | Part Number |
| SPEC NO. | Spec Number |
| LOT NO.  | Lot Number  |

Fig. 2-3 Label Form Specification

### 2.2 Moisture Resistant Packing

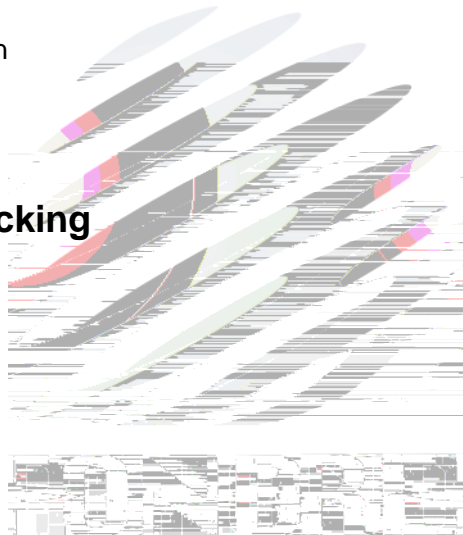

Fig.2-4 Moisture Resistant Packing

## 2.3 Cardboard Box

Fig.2-5 Cardboard Box

## 2.4 Reliability Test Items And Conditions

Table 2-3 Reliability Test Items And Conditions

| Test Items               | Ref.Standard | Test Condition                    | Time       | Quantity | Ac/Re / |
|--------------------------|--------------|-----------------------------------|------------|----------|---------|
| Reflow                   | JESD22-B106  | Temp:260 max<br>T=10 sec          | 2 times    | 22Pcs.   | 0/1     |
| Temperature Cycle        | JESD22-A104  | 100 30 min<br>5 min<br>-40 30 min | 100 cycles | 22Pcs.   | 0/1     |
| Thermal Shock            | JESD22-A106  | -40 15min<br>100 15min            | 300 cycles | 22Pcs.   | 0/1     |
| High Temperature Storage | JESD22-A103  | Temp:100                          | 1000 hrs.  | 22Pcs.   | 0/1     |
| Low Temperature Storage  | JESD22-A119  | Temp:-40                          | 1000 hrs.  | 22Pcs.   | 0/1     |

Life Test

JESD22-A108

## 2.5 Criteria For Judging Damage

Table 2-4 Criteria For Judging Damage

| Test Items      | Symbol | Test Condition | Criteria For Judgement |             |
|-----------------|--------|----------------|------------------------|-------------|
|                 |        |                |                        | Max.        |
| Forward Voltage | $V_F$  | $I_F=20mA$     | -                      | U.S.L*)x1.1 |
| Reverse Current | $I_R$  | $V_R= 5V$      | -                      | U.S.L*)x2.0 |
| Luminous Flux   |        | $I_F=20mA$     | L.S.L*)x0.7            | -           |

### Notes

1.U.S.L: Upper standard level

L.S.L: Lower standard level

2.The above reliability tests is based on the verification of a single/strip LED of Refond's existing experimental platform,the reliability experiment was taken under good heat dissipation conditions. When customers applies the LED to the series and parallel circuit,should take consideration of all the factors such as the current, voltage distribution, heat dissipation and others.

LED

3.The technical information shown in the data sheets is limited to the typical characteristics and circuit examples of the referenced products. It does not constitute the warranting of industrial property nor the granting of any license.

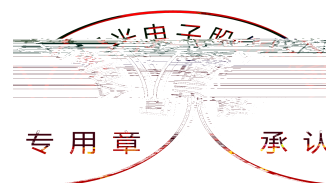

### 3. SMT Reflow Soldering Instructions SMT

#### 3.1 SMT Reflow Soldering Instructions SMT

Fig.3-1 SMT Reflow Soldering Instructions SMT

Table 3-1 Parameters 60

|  |                       |            |             |
|--|-----------------------|------------|-------------|
| Average temperature rise speed                             | $T_{smax} - T_P$      | 3 °C/ s    | Max 3 °C/ s |
| Preheating: minimum temperature                            | ( $T_{smin}$ )        | 150 °C     |             |
| Preheating: Max temperature                                | ( $T_{smax}$ )        | 200 °C     |             |
| Preheating: Time   | $T_{smin} - T_{smax}$ | 60 - 120 s | 60s-120s    |
| Time limited to maintain high temperature: the temperature | ( $T_L$ )             | 217 °C     |             |
| Time limited to maintain high temperature: The Time        | ( $t_L$ )             | 60 s       | Max 60s     |
| Peak /Classification of temperature:                       | ( $T_P$ )             | 260 °C     |             |

Time limit classification of peak temperature time

$t_p$



|       |                              |   |               |
|-------|------------------------------|---|---------------|
| 25 °C | Needed time from 25 °C to Tp | 8 | Max 8 minutes |
|-------|------------------------------|---|---------------|

### Notes

(1)Reflow soldering should not be done more than twice.If more than 24 hours between the two solderings,LED will be damaged. 24 \_\_\_\_\_LED\_\_\_\_\_

(2)Whensoldering , do not put stress on the LEDs during heating.

### 3.1.1 Soldering Iron

(1) When do soldering by hand, keep the temperature of iron below less 300°C less than 3 seconds. 300 3

(2) Soldering by hand should be done only one time.

### 3.1.2 Repairing

Repairing



(3) Do not apply mechanical force or excess vibration during the cooling process to normal temperature after soldering. Do not rapidly cool device after soldering.

## 4. Handling Precautions

### 4.1 Handling Precautions

(1) LED operating environment and sulfur element composition cannot be over 100PPM in the LED mating usage material. This is provided for informational purposes only and is not a warranty or endorsement. LED LED 100PPM.

(2) In order to prevent external material from getting into the inside of LED, which may cause the malfunction of LED, the single content of Bromine element is required to be less than 900PPM, the single content of Chlorine element is required to be less than 900PPM, the total content of Bromine element and Chlorine element in the external materials of the application products is required to be less than 1500PPM. This is provided for informational purposes only and is not a warranty or endorsement. LED LED 900PPM 900PPM 1500PPM.

(3) VOCs (Volatile organic compounds) emitted from materials used in the construction of fixtures can penetrate silicone encapsulants of LEDs and discolor when exposed to heat and photonic energy. The result can be a significant loss of light output from the fixture. Knowledge of the properties of the materials selected to be used in the construction of fixtures can help prevent these issues. Refond advises against the use of any chemicals or materials that have been found or are suspected to have an adverse effect on device performance or reliability. To verify compatibility, Refond recommends that all chemicals and materials be tested in the specific application and environment for which they are intended to be used. Attaching LEDs, do not use adhesives that outgas organic vapor.

LED  
LED

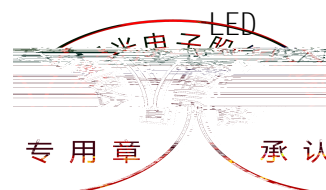

LED

(4) Handle the component along the side surface by using forceps or appropriate tools; Do not directly touch or Handle the silicone lens surface, it may damage the internal circuitry.

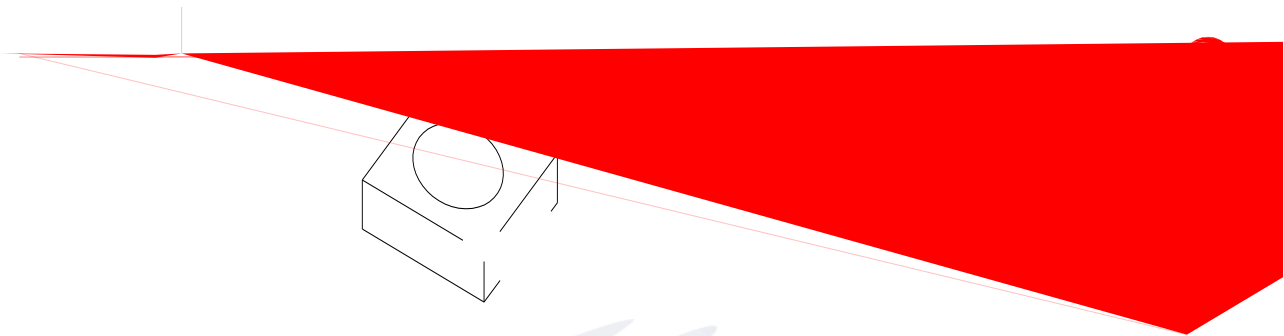

Fig 4-1 产品使用注意事项

(5) In designing a circuit,the current through each LED can not exceed the absolute maximum rating specified for each LED.In the mean while,resistors for protection should be applied,otherwise slight voltage shift will cause big current change,burn out may happen. The driving circuit must be designed to allow forward voltage only when it is ON or OFF.If the reverse voltage is applied to LED, migration can be generated resulting in LED damage.

LED



LED

(6) Thermal Design is paramount importance because heat generation may result in the Characteristics decline,such as brightness decreased,Color change and so on.Please consider the heat generation of the LEDs when making the system design.LED

LED

(7) Compared to standard encapsulants, silicone is generally softer, and the surface is more likely to attract dust,requiring special care during processing. In cases where a minimal level of dirt and dust particles cannot be guaranteed, a suitable cleaning solution must be applied to the surface after the soldering of components. Refond suggests using isopropyl alcohol for cleaning. In case

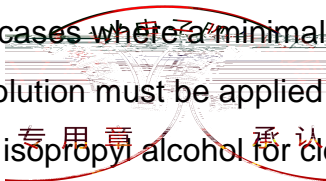

other solvents are used, it must be assured that these solvents do not dissolve the package or resin. Ultrasonic cleaning is not recommended. Ultrasonic cleaning may cause damage to the LED.

## LED

Table 4-1 Storage

| Conditions |                             | Temperature | Humidity | Time                    |
|------------|-----------------------------|-------------|----------|-------------------------|
| Storage    | Before Opening Aluminum Bag | 30          | 75%      | Within 1 Year From Date |
|            | After Opening Aluminum Bag  | 30          | 60%      | 24hours<br>24           |
| Baking     |                             | 60± 5       | -        | 24hours<br>24           |

(8) If the moisture absorbent material silica gel has faded away or the LEDs have exceeded the storage time, baking treatment should be performed after unpacking and based on the following condition 65±5 °C for above 24 hours.

60± 5      24

If the package is flatulence or damaged, please notify the sales staff to assist.

(9) Similar to most Solid state devices; LEDs are sensitive to Electro-Static Discharge (ESD) and Electrical Over Stress (EOS).

LED

(10) Other points for attention, please refer to our relevant information.





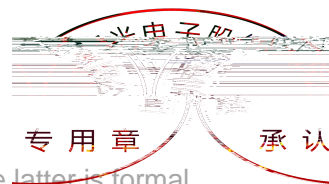

Declare  
This specification is written both in English and in Chinese and the latter is formal.