

SPECIFICATION

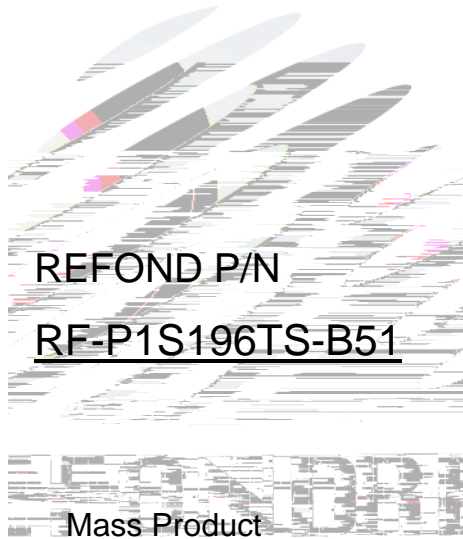

Contents

1. Description	
1.1 General Description	
1.2 Features	
1.3 Application	
1.4 Package Dimension	
1.5 Product Parameters	
1.6 Typical Optical Characteristics Curves	
2. Packaging	
2.1 Packaging Specification	
2.1.1 Carrier Tape Dimension	11
2.1.2 Reel Dimension	11
2.1.3 Label Form Specification	12
2.2 Moisture Resistant Packing	
2.3 Cardboard Box	
2.4 Reliability Test Items And Conditions	
2.5 Criteria For Judging Damage	
3. SMT Reflow Soldering Instructions SMT	
3.1 SMT Reflow Soldering Instructions SMT	
4. Handling Precautions	
4.1 Handling Precautions	

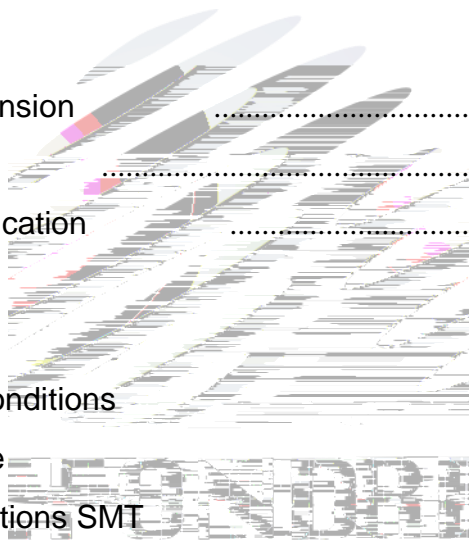

1. Description

1.1 General Description

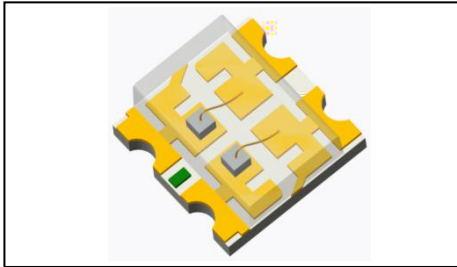

The Colour LED which was fabricated using a yellow chip and yellow-green chip , Package Dimension : 1.6mmX1.6mmX0.7mm.

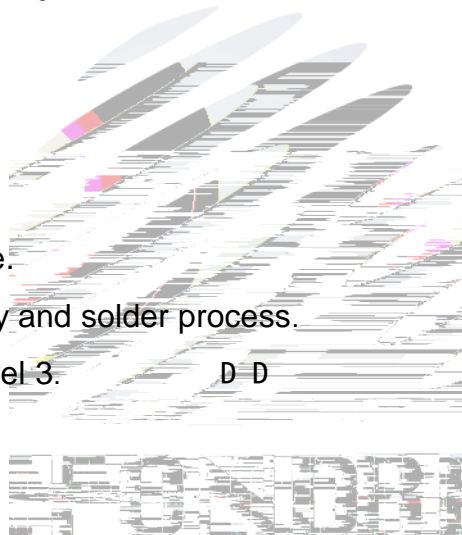

1.6mmX1.6mmX0.7mm

1.2 Features

Extremely wide viewing angle.

Suitable for all SMT assembly and solder process. 2, 3

Moisture sensitivity level: Level 3. D-D

RoHS compliant. 2

1.3 Application

Optical indicator.

Switch and symbol, display.

General use.



1.4 Package Dimension

1 Top vFig.1

Fig.1-1 Top view 4 0.09 (Fi)-7 (9) (1) T 1a5* n4s T 1 1 89

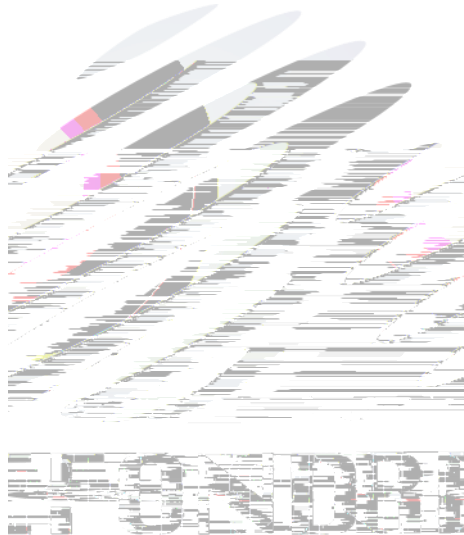

1.5 Product Parameters

Table 1-1 Electrical / Optical Characteristics at Ts=25°C

Item	Test Condition	Symbol		Code	Value			Unit
					Min. ()	Typ.	Max.	
Spectral Half Bandwidth	I _F =20mA	Δ	Y	/	--	15	--	nm
			YG		--	15	--	
Forward Voltage	I _F =20mA	V _F	Y	1L	1.8	--	2.4	V
			YG	1L	1.8	--	2.4	
Dominant wavelength	I _F =20mA	λ _d	Y	D00	585.0	--	590.0	nm
				E00	590.0	--	595.0	
			YG	B10	565	--	567.5	
				B20	567.5	--	570.0	
				C10	570	--	572.5	
				C20	572.5	--	575	
Luminous Intensity	I _F =20mA	I _v	Y	1DW	70	--	90	mcd
				1AP	90	--	120	
				G20	120	--	150	
			YG	1AW	150	--	200	
				C00	18	--	28	
				D00	28	--	43	
				E00	43	--	65	
				F00	65	--	80	
				F20	80	--	100	
Viewing Angle	I _F =20mA	! !			--	140	--	deg
Reverse Current	V _R =5V	I _R			--	--	10	A
Thermal Resistance.	I _F =20mA	R _{THJ-S}			--	--	450	/W

Notes : V_R=5V For test conditions. V_R=5V



Table 1-2 Absolute Maximum Ratings at Ts=25°C

Parameter	Symbol	Rating		Units
		Y	YG	
Power Dissipation	P_d			

Notes

- 1/10 Duty cycle, 0.1ms pulse width. LR
- The above forward voltage measurement allowance tolerance is $\pm 0.1V$. 5
- The above dominant wavelength measurement allowance tolerance is $\pm 2nm$. ML
- The above luminous intensity measurement allowance tolerance $\pm 10\%$.
- Care is to be taken that power dissipation does not exceed the absolute maximum rating of the product.
- All measurements were made under the standardized environment of Refond.
- When the LEDs are in operation the maximum current should be decided after measuring the package temperature, junction temperature should not exceed the maximum rate

1.6 Typical Optical Characteristics Curves

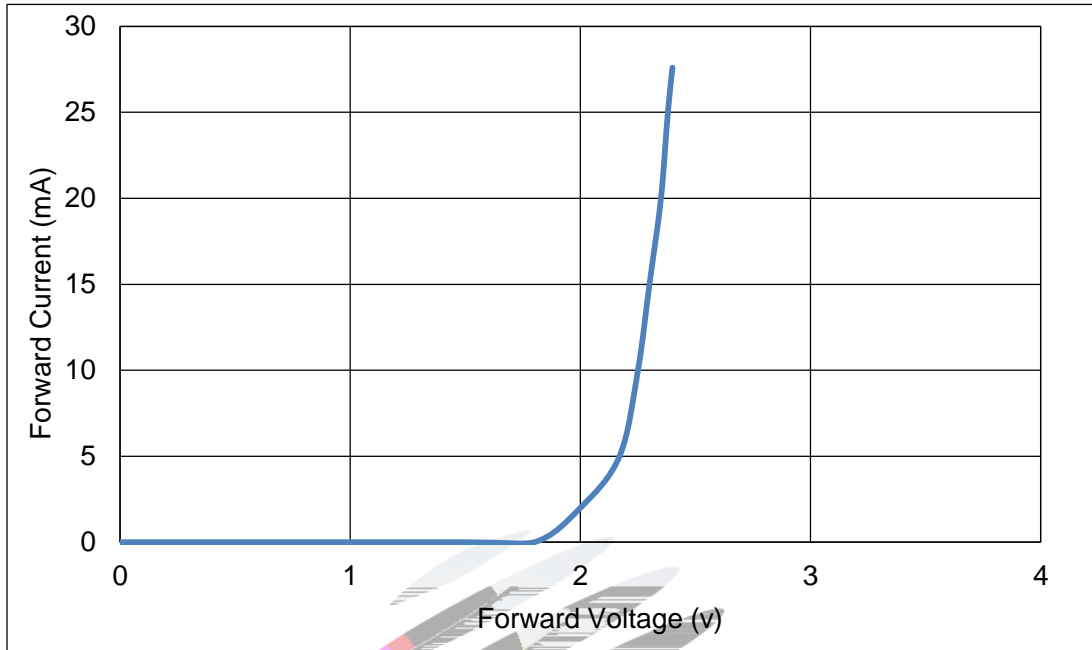

Fig.1-6 Forward Voltage Vs Forward Current

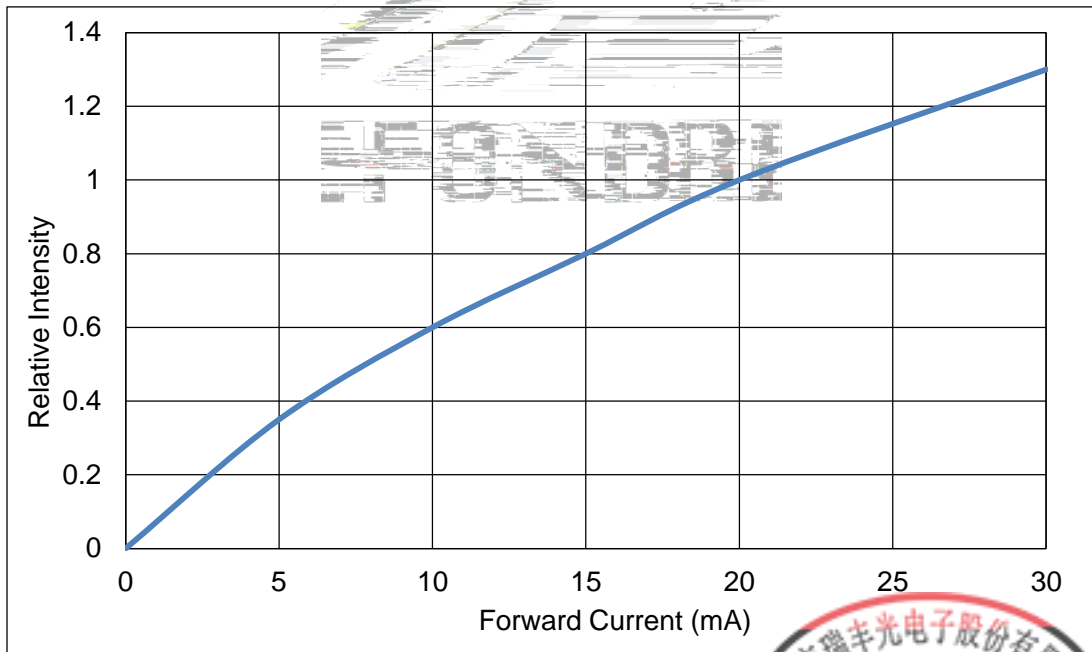
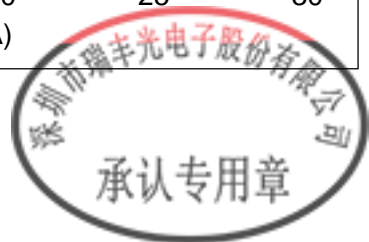

Fig.1-7 Forward Current Vs Relative Intensity



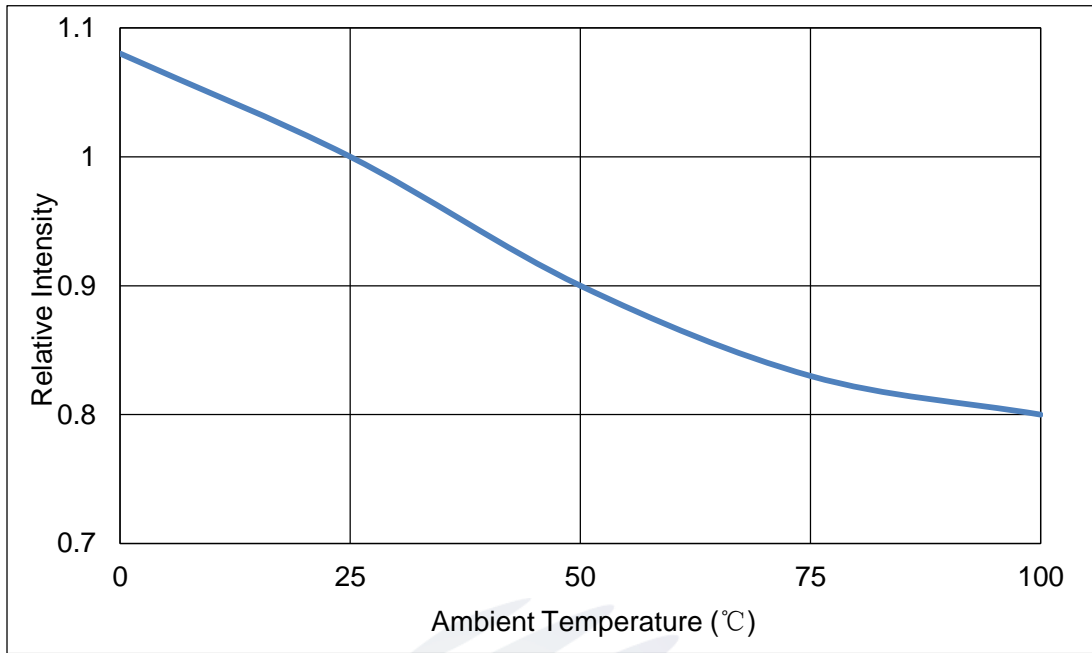

Fig.1-8 Pin Temperature Vs Relative Intensity

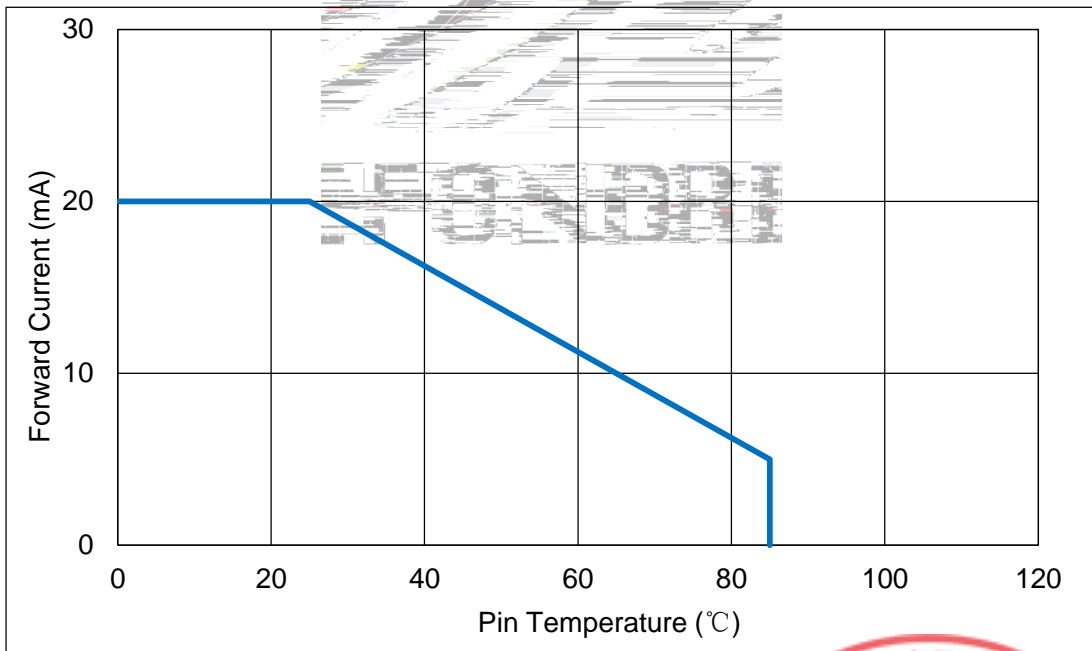

Fig.1-9 Pin Temperature Vs Forward Current





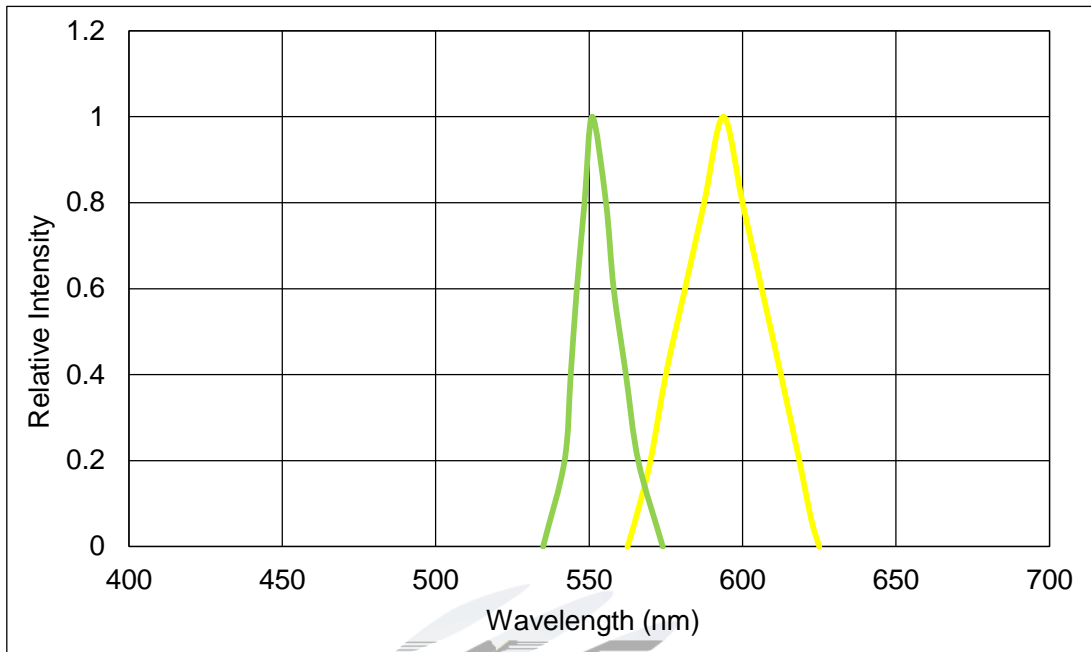

Fig.1-12 Relative Intensity Vs Wavelength (Ta=25°C)

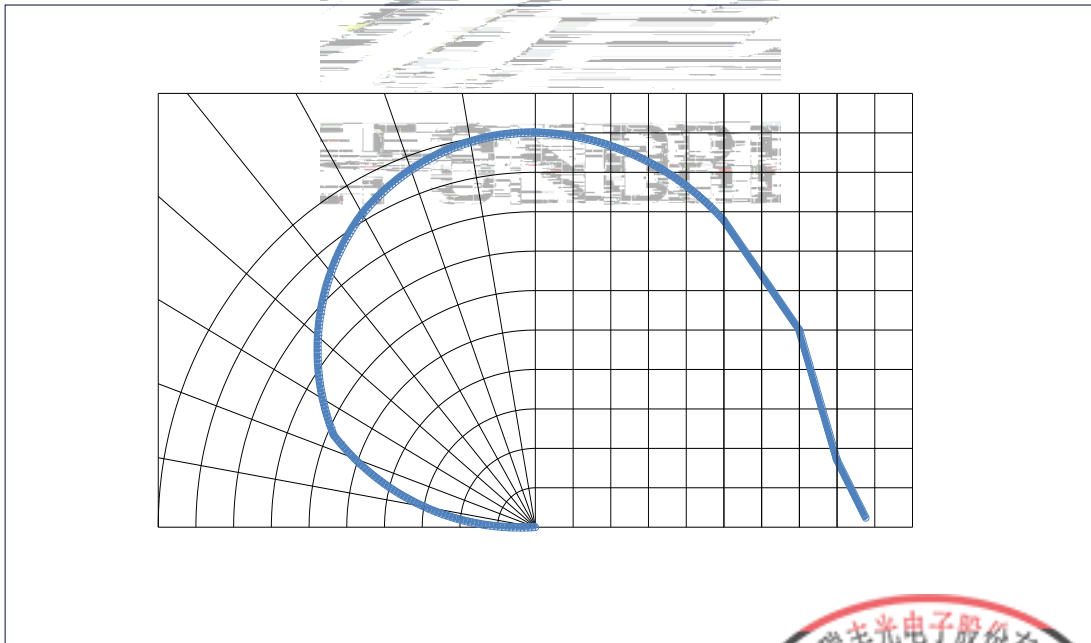
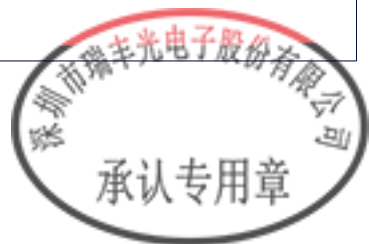

Fig.1-13 Diagram characteristics of radiation



2. Packaging

2.1 Packaging Specification

Package: 4000pcs/reel. 4000pcs

2.1.1 Carrier Tape Dimension

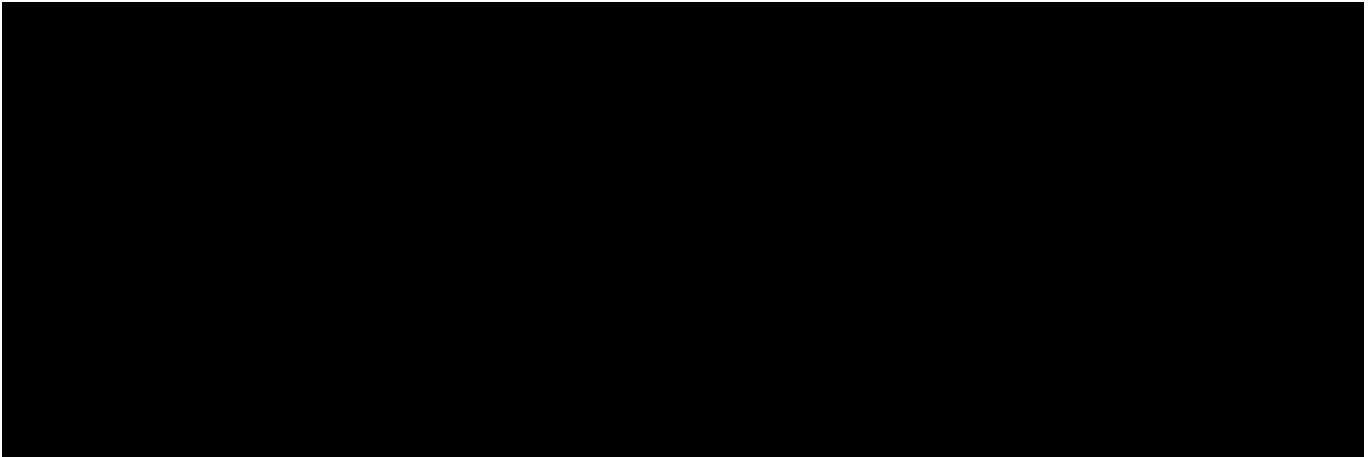

Fig.2-1 Carrier Tape Dimension

2.1.2 Reel Dimension

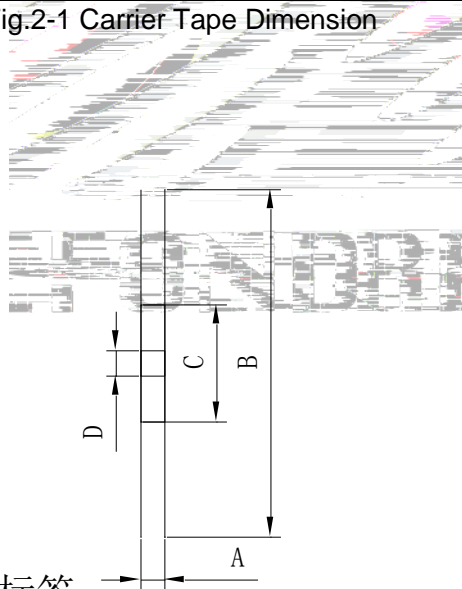
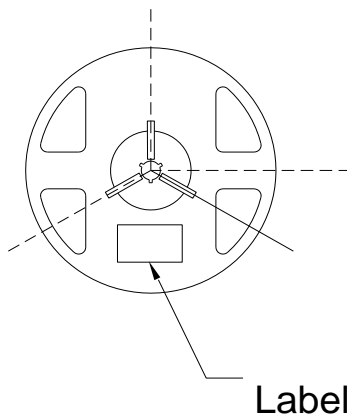

Table 2-1 Dimension

A	8.0 0.1mm
B	178 1mm
C	60 1mm
D	13.0 0.5mm

Fig.2-2 Reel Dimension

Notes

The tolerances unless mentioned $\pm 0.1\text{mm}$. Unit : mm



2.1.3 Label Form Specification



PART NO:		
SPEC NO:		
LOT NO		
BIN CODE:		
Φ:	XY:	
VF:	WLD:	
		
	QTY:	
	DATE:	

Table 2-2 Parameter

PART NO.	Part Number
SPEC NO.	Spec Number
LOT NO.	Lot Number
BIN CODE	Bin Code
	Luminous flux
XY	Chromaticity Bin
V _F	Forward Voltage
WLD	Wavelength
QTY	Packing Quantity
DATE	Made Date

Fig. 2-3 Label Form Specification

2.2 Moisture Resistant Packing



Fig.2-4 Moisture Resistant Packing



2.3 Cardboard Box

en- Tm432.

Fig.2-5 Cardboard Box

2.4 Reliability Test Items And Conditions

Table 2-3 Reliability Test Items And Conditions

Test Items

Ref.Standard

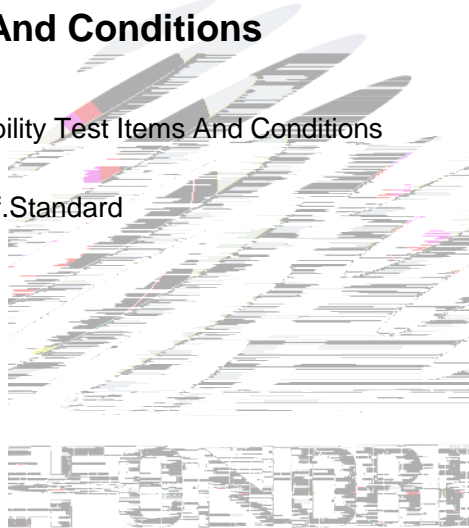

2.5 Criteria For Judging Damage

Table 2-4 Criteria For Judging Damage

Test Items	Symbol	Test Condition	Criteria For Judgement	
			Min.	Max.
Forward Voltage	V_F	$I_F=20mA$	-	U.S.L*)x1.1
Reverse Current	I_R	$V_R= 5V$	-	U.S.L*)x2.0
Luminous Flux		$I_F=20mA$	L.S.L*)x0.7	-

Notes

1.U.S.L: Upper standard level

L.S.L: Lower standard level

2.The above reliability tests is based on the verification of a single/strip LED of Refond's existing experimental platform,the reliability experiment was taken under good heat dissipation conditions. When customers applies the LED to the series and parallel circuit,should take consideration of all the factors such as the current, voltage distribution, heat dissipation and others.

3.The technical information shown in the data sheets is limited to the typical characteristics and circuit examples of the referenced products. It does not constitute the warranting of industrial property nor the granting of any license.



3. SMT Reflow Soldering Instructions SMT

3.1 SMT Reflow Soldering Instructions SMT

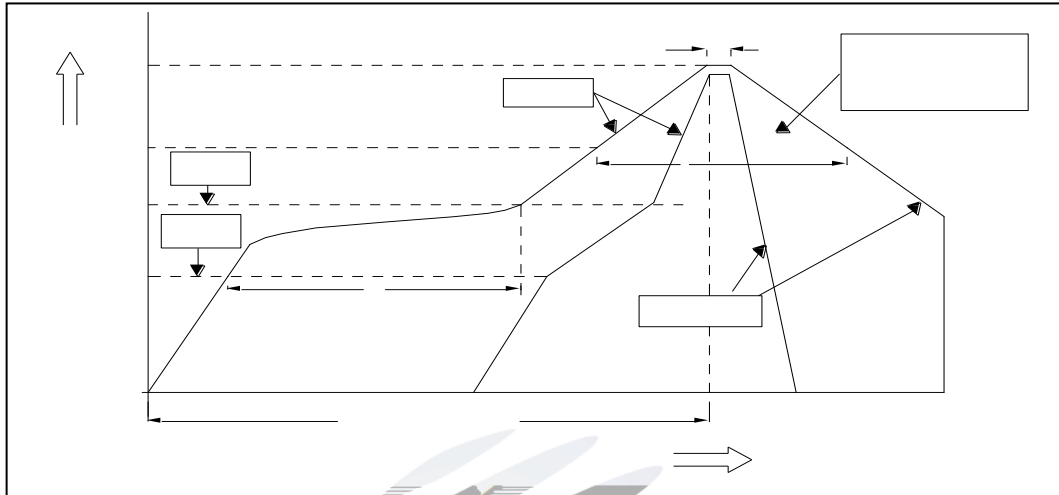
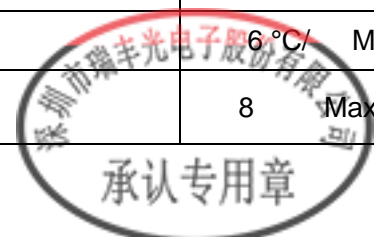

Fig.3-1 SMT Reflow Soldering Instructions SMT

Table 3-1 Parameter

Average temperature rise speed	T_{sm}	T_P	3 °C/	Max 3 °C/ s
Preheating: minimum temperature	(Tsmmin)		150 °C	
Preheating: Max temperature	(Tsmmax)		200 °C	
Preheating: Time	Tsmmin	Tsmmax	60 - 120	60s-120s
Time limited to maintain high temperature: the temperature	(Tl)		217 °C	
Time limited to maintain high temperature: The Time	(t)		60 - 150	60s-150s
Peak /Classification of temperature:	/ (Tp)		260 °C	
Time limit classification of peak temperature time	t_p		10	Max 10s
Hold time within 5 °C with the actual peak temperature (TP)	(Tp)		30	Max 30s
Cooling speed			6 °C/	Max 6 °C/ s
Needed time from 25 °C to Tp	25 °C		8	Max 8 minutes



Notes

(1)Reflow soldering should not be done more than twice. If more than 24 hours between the two solderings , LED will be damaged.

(2)Whensoldering , do not put stress on the LEDs during heating.

3.1.1 Soldering Iron

(1) When do soldering by hand, keep the temperature of iron below less 300°C less than 3 seconds.

(2) Soldering by hand should be done only one time.

3.1.2 Repairing

Repairing should not be done after the LEDs have been soldered. When repairing is unavoidable,a double-head soldering iron should be used (as below figure). It should be confirmed in advance whether the characteristics of LEDs will or not be damaged by repairing.

LED

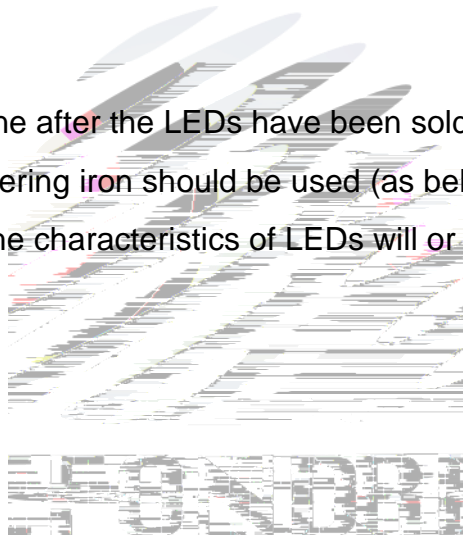

3.1.3 Cautions

(1) Components should not be mounted on warped (non coplanar) portion of PCB. After soldering, do not warp the circuit board.LED "!

(2) Do not apply mechanical force or excess vibration during the cooling process to normal temperature after soldering. Do not rapidly cool device after soldering.



4. Handling Precautions

4.1 Handling Precautions

(1) LED operating environment and sulfur element composition can not be over 100PPM in the LED mating usage material. This is provided for informational purposes only and is not a warranty or endorsement. LED

(2) In order to prevent external material from getting into the inside of LED, which may cause the malfunction of LED, the single content of Bromine element is required to be less than 900PPM, the single content of Chlorine element is required to be less than 900PPM, the total content of Bromine element and Chlorine element in the external materials of the application products is required to be less than 1500PPM. This is provided for informational purposes only and is not a warranty or endorsement.

(3) VOCs (Volatile organic compounds) emitted from materials used in the construction of fixtures can penetrate silicone encapsulants of LEDs and discolor when exposed to heat and photonic energy. The result can be a significant loss of light output from the fixture. Knowledge of the properties of the materials selected to be used in the construction of fixtures can help prevent these issues. Refond advises against the use of any chemicals or materials that have been found or are suspected to have an adverse effect on device performance or reliability. To verify compatibility, Refond recommends that all chemicals and materials be tested in the specific application and environment for which they are intended to be used. Attaching LEDs, do not use adhesives that outgas organic vapor.



(4) Handle the component along the side surface by using forceps or appropriate tools; Do not directly touch or Handle the silicone lens surface, it may damage the internal circuitry.

Fig 4-1

产品使用注意事项

(5) In designing a circuit,the current through each LED can not exceed the absolute maximum rating specified for each LED.In the mean while,resistors for protection should be applied,otherwise slight voltage shift will cause big current change,burn out may happen. The

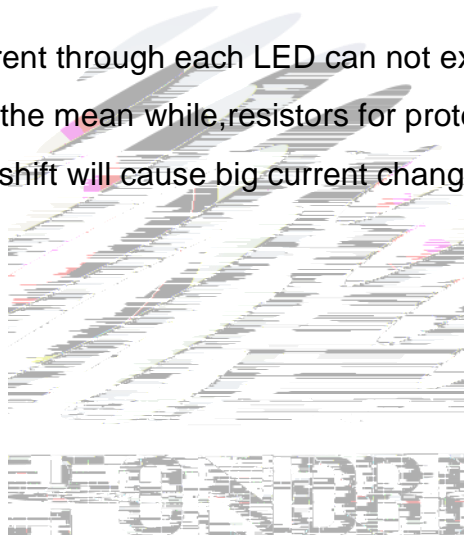

LED.

Table 4-1 Storage

Conditions		Temperature	Humidity	Time
Storage	Before Opening Aluminum Bag	30	75%	Within 1 Year From Date
	After Opening Aluminum Bag	30	60%	168hours 168
Baking		60 ± 5	-	24hours 24

(8) If the moisture absorbent material (silica gel) has faded away or the LEDs have exceeded the storage time, baking treatment should be performed after unpacking and based on the following condition (60±5) °C for above 24 hours.

If the package is flatulence or damaged, please notify the sales staff to assist.

Date	Revisor	Version	Verifier	Remarks
------	---------	---------	----------	---------





Declare

This specification is written both in English and in Chinese and the latter is formal.