

# SPECIFICATION

REFOND P/N

RF-YURA30TS-AE-Z

R&D

Mass Production



# Contents

1. Description	
1.1 General Description	
1.2 Features	
1.3 Application	
1.4 Package Dimension	
1.5 Product Parameters	
1.6 Bin Range Of Forward Voltage and Luminous Intensity	BIN
1.7 Typical Optical Characteristics Curves	
2. Packaging	
2.1 Packaging Specification	
2.1.1 Carrier Tape Dimension	11
2.1.2 Reel Dimension	11
2.1.3 Label Form Specification	12
2.2 Moisture Resistant Packing	
2.3 Cardboard Box	
2.4 Reliability Test Items And Conditions	
2.5 Criteria For Judging Damage	
3. SMT Reflow Soldering Instructions SMT	
3.1 SMT Reflow Soldering Instructions SMT	
4. Handling Precautions	
4.1 Handling Precautions	



# 1. Description

## 1.1 General Description

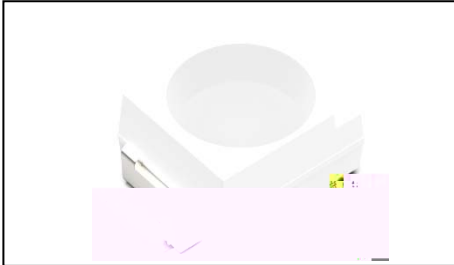

The Yellow source color devices are made with AlGaInP on Substrate Light Emitting Diode .

Product Package:3.50mmX2.80mmX1.84mm.

LED AlGaInP

3.50mmX2.80mmX1.84mm

## 1.2 Features

- ▶ PLCC2 Package.
- ▶ Extremely wide viewing angle.
- ▶ Suitable for all SMT assembly and solder process.
- ▶ Available on tape and reel.
- ▶ Moisture sensitivity level: Level 2.
- ▶ Compliance with RoHS and REACH.      RoHS    REACH
- ▶ Qualifications: The product qualification test plan is based on the guidelines of AEC-Q101 Stress Test Qualification for Automotive Grade Discrete Semiconductors

AEC

## 1.3 Application

- ▶ Automotive Interior Lighting.
- ▶ Switches.



# 1.4 Package Dimension

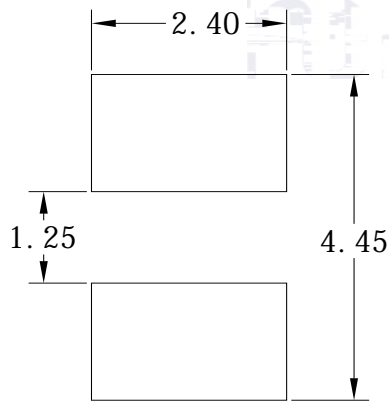
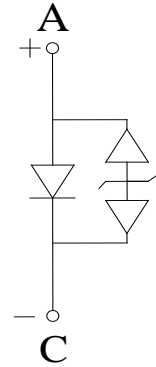
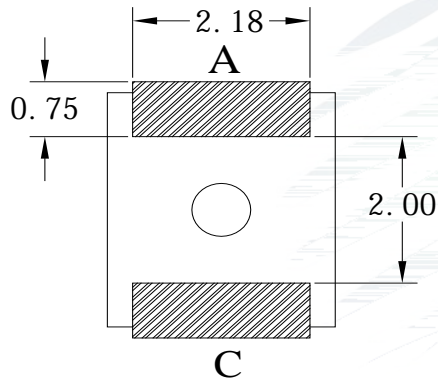
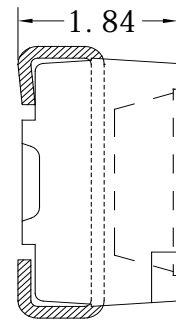
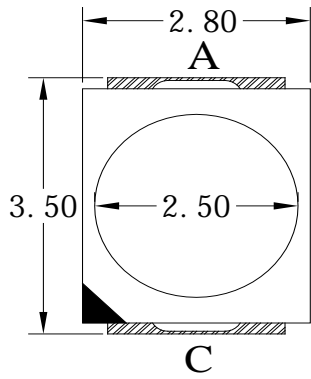

## Notes

All dimensions units are millimeters.

All dimensions tolerances are  $\pm 0.2\text{mm}$  unless otherwise noted.



## 1.5 Product Parameters

Table 1-1 Electrical / Optical Characteristics at Ts=25°C

Item	Symbol	Test Condition	Value			Unit
			Min.	Typ.	Max.	
Forward Voltage	$V_F$	$I_F=20mA$	1.8	2.2	2.4	V
Reverse Current	$I_R$	$V_R=5V$	---	---	10	$\mu A$
Luminous Intensity	$I_V$	$I_F=20mA$	200	300	430	mcd
Dominant wavelength	$\lambda_d$	$I_F=20mA$	585	590	595	nm
Viewing Angle	$2\theta_{1/2}$	$I_F=20mA$	---	120	---	deg
Thermal Resistance.	$R_{THJ-S}$	$I_F=20mA$	---	---	300	$^{\circ}C/W$

Table 1-2 Absolute Maximum Ratings at Ts=25°C

Parameter	Symbol	Rating	Units
Power Dissipation	$P_D$	72	mW
Forward Current	$I_F$	30	mA
Peak Forward Current	$I_{FP}$	50	mA



## 1.7 Typical Optical Characteristics Curves

F



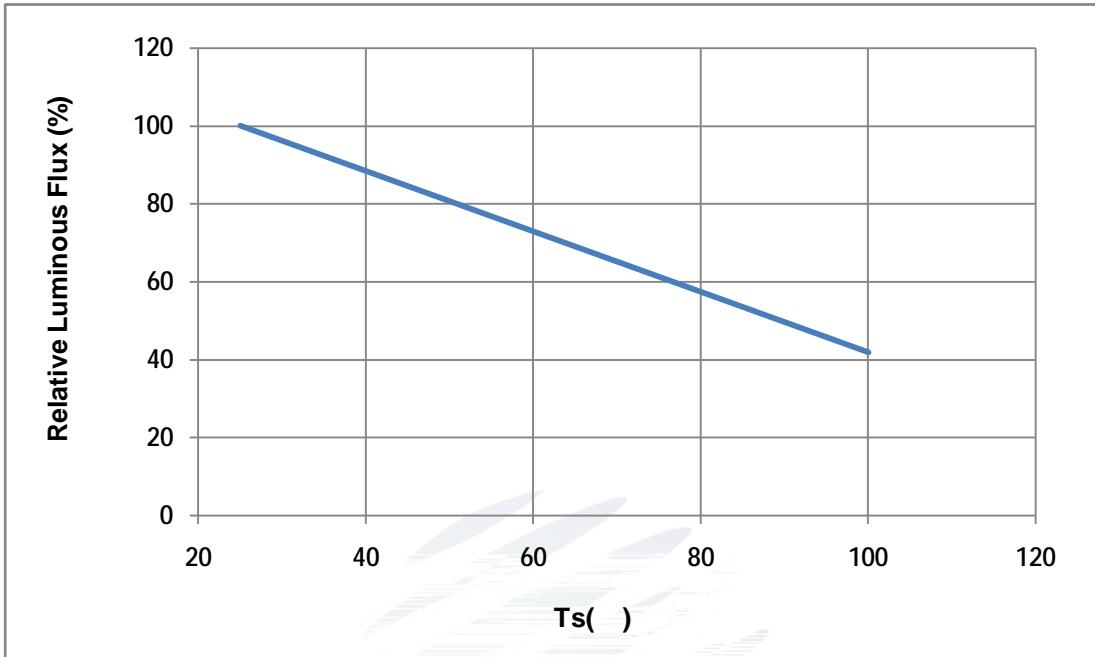

Fig. 1-9 Solder Temperature Vs Relative Intensity

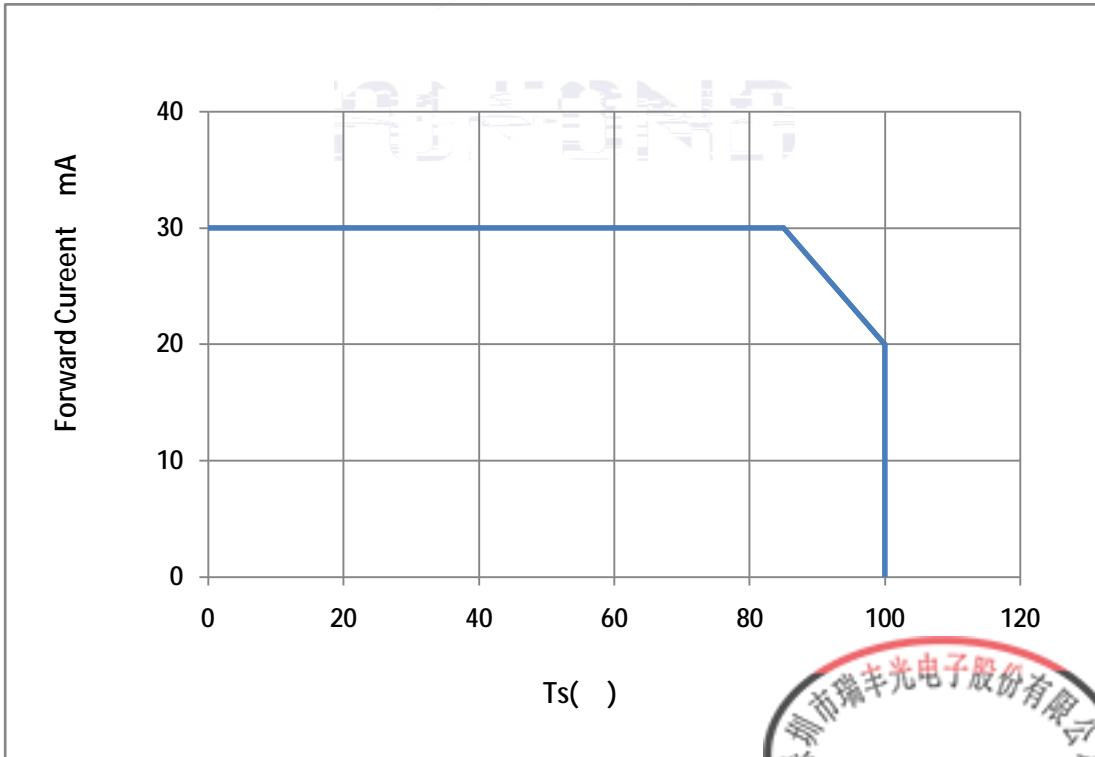

Fig. 1-10 Solder Temperature Vs Forward Current





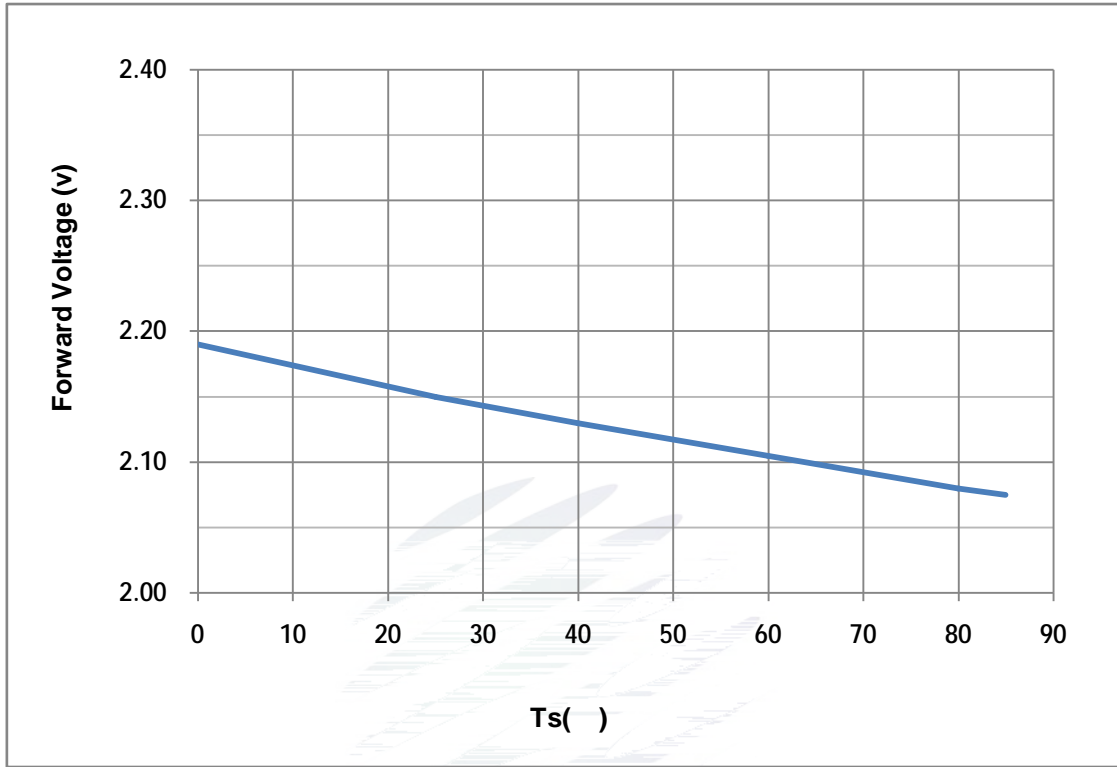

Fig. 1-11 Forward Voltage Vs Solder Temperature

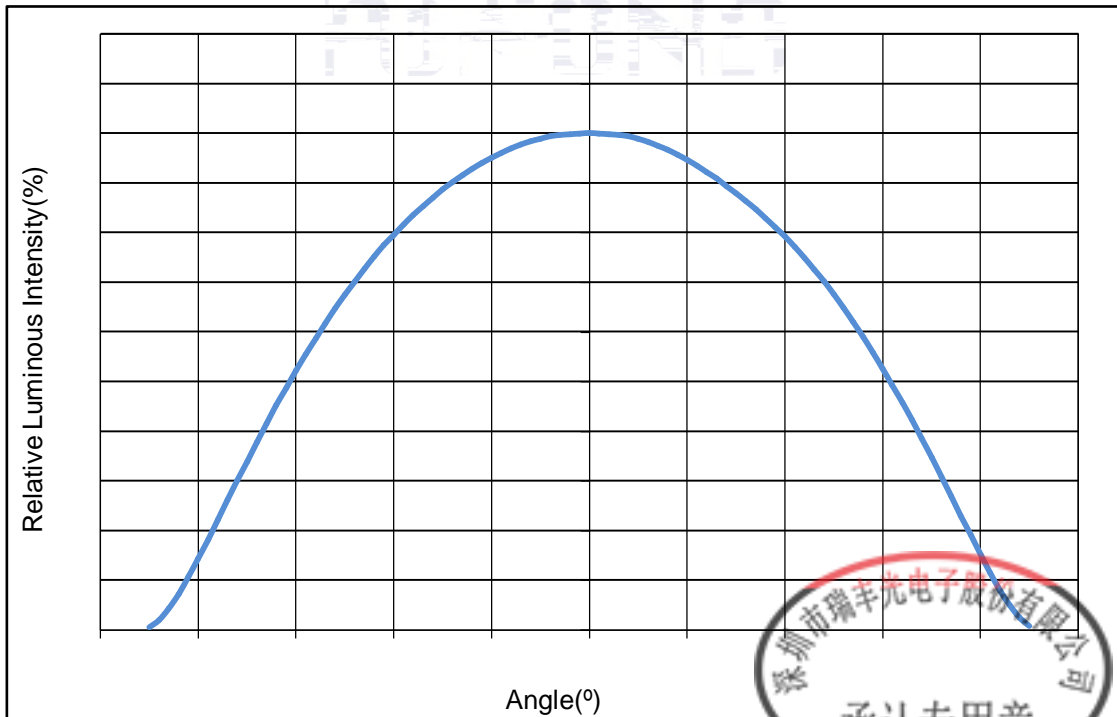
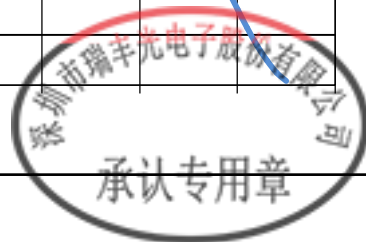

Fig. 1-12 Radiation diagram



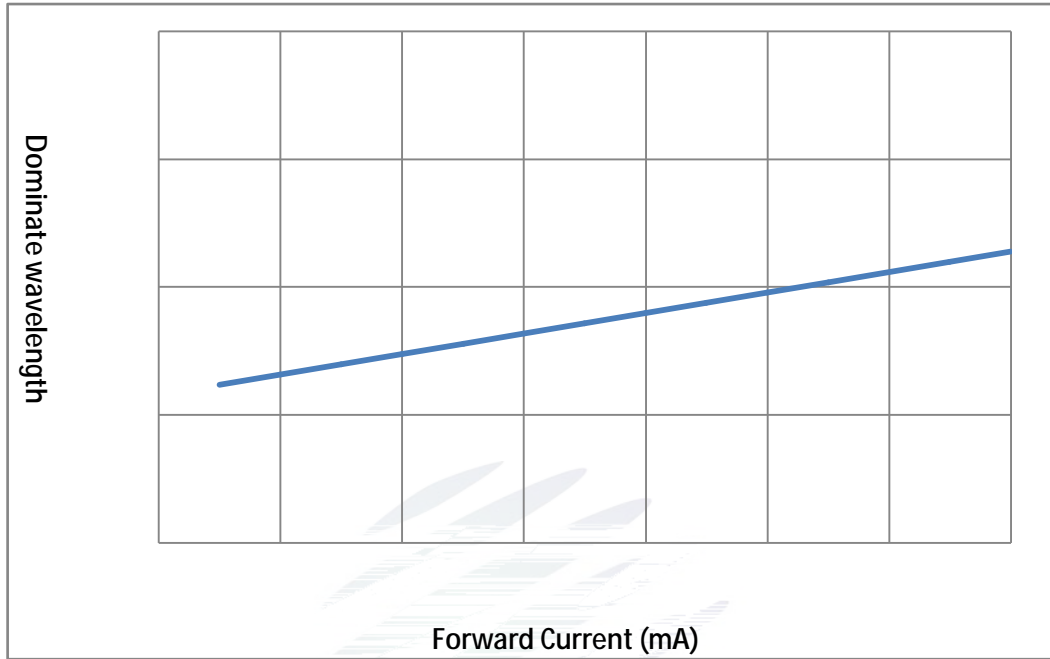

Fig. 1-13 Forward current vs.Dominate wavelength

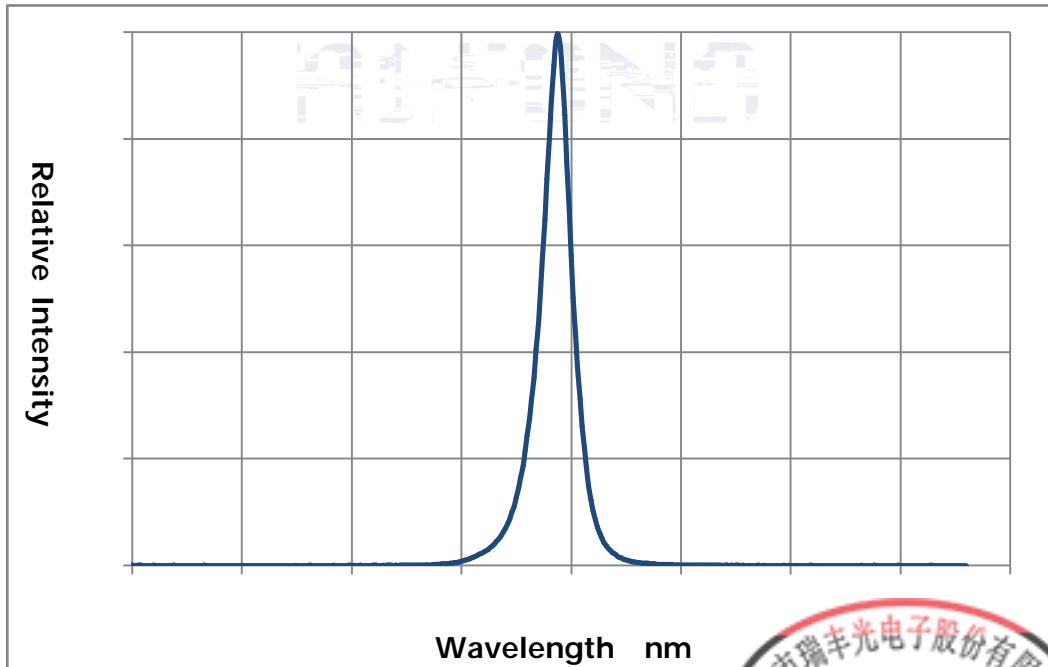

Fig. 1-14 Spectrum Distribution



## 2. Packaging

### 2.1 Packaging Specification

Package:2000pcs/reel.

#### 2.1.1 Carrier Tape Dimension

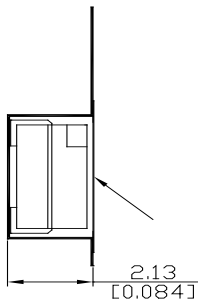

Polarity Mark

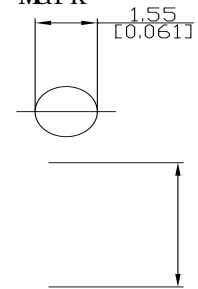

### 2.1.3 Label Form Specification

Table 2 Specification

PART NO.	Part Number
SPEC NO.	Spec Number
LOT NO.	Lot Number
BIN CODE	Bin Code
$\Phi$	Luminous flux
XY	Chromaticity Bin
$V_F$	Forward Voltage
WLD	Wavelength
QTY	Packing Quantity
DATE	Made Date

Fig. 2-3 Label Form Specification

### 2.2 Moisture Resistant Packing

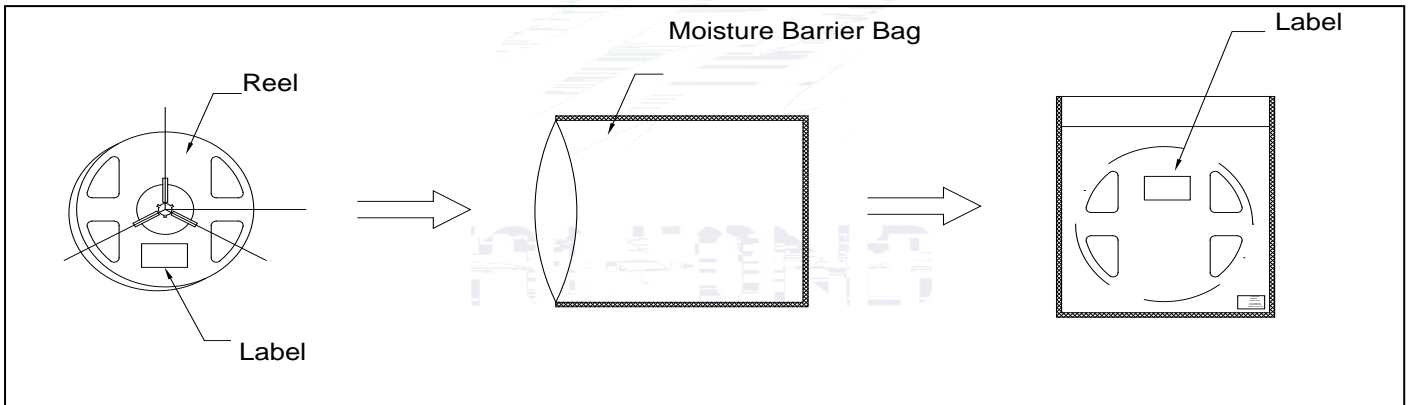

Fig.2-4 Moisture Resistant Packing

### 2.3 Cardboard Box

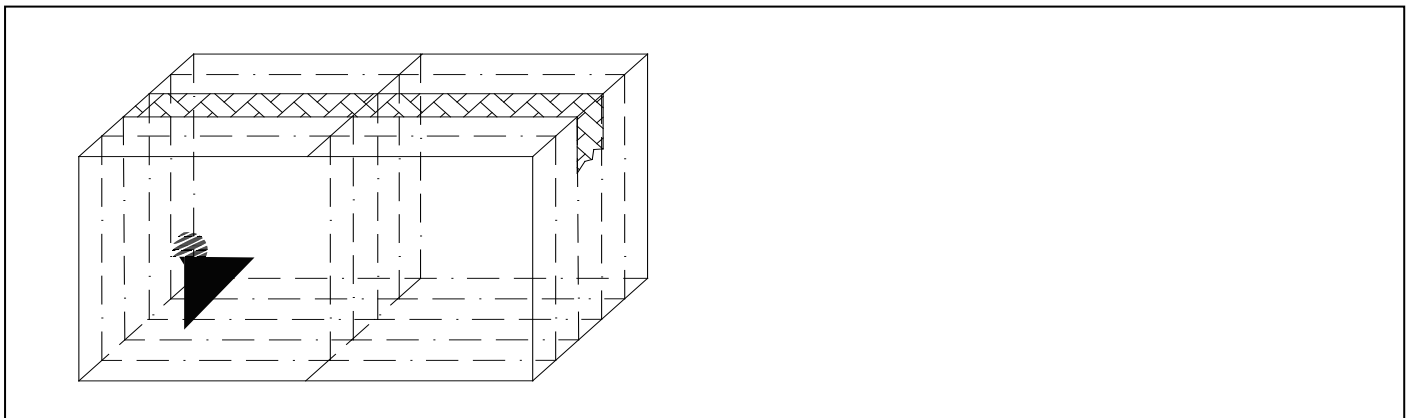

Fig.2-5 Cardboard Box



## 2.5 Criteria For Judging Damage

Table 2-4 Criteria For Judging Damage

Test Items	Symbol	Test Condition	Criteria For Judgement	
			Min.	Max.
Forward Voltage	$V_F$	$I_F=20mA$	-	U.S.L*)x1.1
Reverse Current	$I_R$	$V_R = 5V$	-	U.S.L*)x2.0
Luminous Flux	$\Phi$	$I_F=20mA$	L.S.L*)x0.7	-

### Notes

- 1.U.S.L: Upper standard level                      L.S.L: Lower standard level
- 2.The above reliability tests is based on the verification of a single/strip LED of Refond's existing experimental platform,the reliability experiment was taken under good heat dissipation conditions. when customers applies the LED to the series and parallel circuit, should take consideration of all the factors such as the current, voltage distribution, heat dissipation and others.
- 3.The technical information shown in the data sheets is limited to the typical characteristics and circuit examples of the referenced products. It does not constitute the warranting of industrial property nor the granting of any license.



### 3. SMT Reflow Soldering Instructions SMT

#### 3.1 SMT Reflow Soldering Instructions SMT

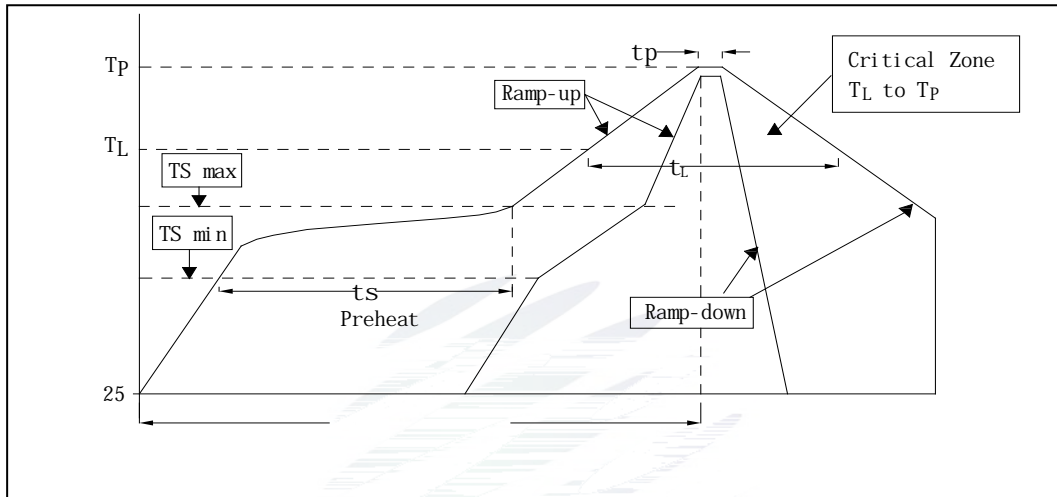

Fig.3-1 SMT Reflow Soldering Instructions SMT

Table 3-1 Reflow parameters

Average temperature rise speed	Tsmax TP	3 °C/ Max 3 °C/ s
Preheating: minimum temperature	(Tsmin)	150 °C
Preheating: Max temperature	(Tsmax)	200 °C
Preheating: Time	Tsmin Tsmax	60 - 120 60s-120s
Time limited to maintain high temperature: the temperature	(TL)	217 °C
Time limited to maintain high temperature: The Time	(tL)	60 Max 60s
Peak /Classification of temperature:	(TP)	260 °C
Time limit classification of peak temperature time	tp	10 Max 10s
(TP) 5 °C	Hold time within 5 °C with the	30 Max 30s
actual peak temperature (TP)		
Cooling speed		6 °C/ Max 6 °C/ s
25 °C	Needed time from 25 °C to TP	8 Max 8 minutes

Notes

(1)Reflow soldering should not be done more than twice. If more than 24 hours between the two solderings , LED will be damaged. LED

(2)When soldering , do not put stress on the LEDs during heating.

3.1.1 Soldering Iron

(1) When do soldering by hand, keep the temperature of iron below less 300 less than 3 seconds. , 300 3

(2) Soldering by hand should be done only one time.

3.1.2 Repairing

Repairing should not be done after the LEDs have been soldered. When repairing is unavoidable,a double-head soldering iron should be used (as below figure). It should be confirmed in advance whether the characteristics of LEDs will or not be damaged by repairing.

LED

LED

3.1.3 Cautions

(1) The encapsulated material of the LEDs is silicone. Therefore the LEDs have a soft surface on the top of package. The pressure to the top surface will be impacted on the reliability of the LEDs. Precautions should be taken to avoid the strong pressure on the encapsulated part. So when use the picking up nozzle, the pressure on the silicone resin should be proper. LED LED

(2) Components should not be mounted on warped (non coplanar) portion of PCB. After soldering, do not warp the circuit board.LED PCB

(3) Do not apply mechanical force or excess vibration during the cooling process to normal temperature after soldering. Do not rapidly cool device after soldering.





## 4. Handling Precautions



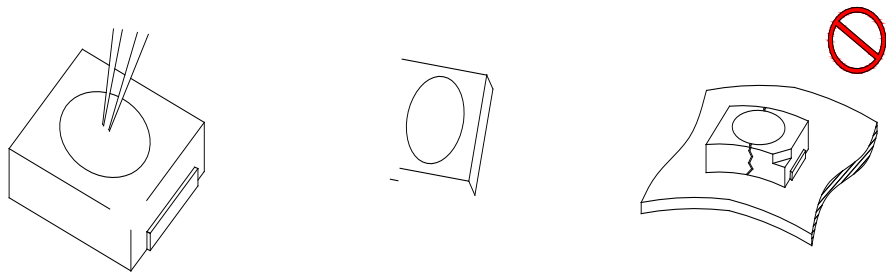

Fig 4-1 Handling Precautions

(5) In designing a circuit, the current through each LED can not exceed the absolute maximum rating specified for each LED. In the mean while, resistors for protection should be applied, otherwise slight voltage shift will cause big current change, burn out may happen. The driving circuit must be designed to allow forward voltage only when it is ON or OFF. If the reverse voltage is applied to LED, migration can be generated resulting in LED damage.

LED

LED

(6) Thermal Design is paramount importance because heat generation may result in the Characteristics decline, such as brightness decreased, Color change and so on. Please consider the heat generation of the LEDs when making the system design.

LED

(7) Compared to standard encapsulants, silicone is generally softer, and the surface is more likely to attract dust, requiring special care during processing. In cases where a minimal level of dirt and dust particles cannot be guaranteed, a suitable cleaning solution must be applied to the surface after the soldering of components. Refond suggests using isopropyl alcohol for cleaning. In case other solvents are used, it must be assured that these solvents do not dissolve the package or resin. Ultrasonic cleaning is not recommended. Ultrasonic cleaning may cause damage to the LED.

LED

Table 4-1 Storage

Conditions		Temperature	Humidity	Time
Storage	Before Opening Aluminum Bag	30	75%	Within 1 Year From Date
	After Opening Aluminum Bag	30	60%	Recommended for use within 24 hours
Baking		60±5	-	24hours 24

(8) If the moisture absorbent material silica gel has faded away or the LEDs have exceeded the storage time, baking treatment should be performed after unpacking and based on the following condition 60 5 for above 24 hours.

60 5 24

If the package is flatulence or damaged, please notify the sales staff to assist.

(9) Similar to most Solid state devices; LEDs are sensitive to Electro-Static Discharge (ESD) and Electrical Over Stress (EOS). LED

(10) Other points for attention, please refer to our relevant information.







www.refond.com

REFOND



Declare

This specification is written both in English and in Chinese and the latter is formal.