



SPECIFICATION

REFOND P/N

RF-GNRL30TS-CG-G(WE)

Mass Production





Contents

1. Declaration of the Company's Financial Statements for the Year 2021 (1.2)(D)6(10scr)25(i)-13/TT2 1 Tf





1. Description

1.1 General Description



The Green source color devices are made with InGaN on Substrate Light Emitting Diode .
Product Package:3.50mmX2.80mmX3.50mm.

InGaN

3.50mmX2.80mmX3.50mm

1.2 Features

PLCC4 Package.

extremely narrow angle.

Suitable for all SMT assembly and solder process.

Available on tape and reel.

Moisture sensitivity level: Level 2.

RoHS compliant. 符合RoHS要求

Qualifications: The product qualification test plan is based on the guidelines of AEC-Q102 Stress Test Qualification for Automotive Grade Discrete Semiconductors

1.3 Application

Automotive Lighting Interior and Exterior.





1.4 Package Dimension

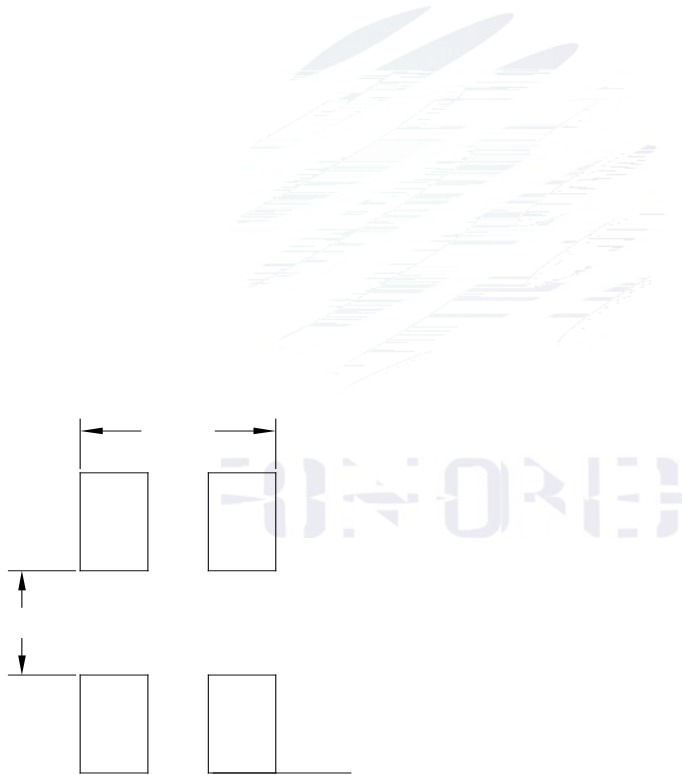

Notes

All dimensions units are millimeters.

All dimensions tolerances are $\pm 0.2\text{mm}$ unless otherwise noted.



1.5 Product Parameters

Table 1-1 Electrical / Optical Characteristics at Ts=25°C

Item	Symbol	Test Condition	Value			Unit
			Min.	Typ.	Max.	
Forward Voltage	V_F	$I_F=50mA$	2.9	3.2	3.5	V
Reverse Current	I_R	$V_R=5V$	---	---	10	μA
Luminous Intensity		$I_F=50mA$	15000	25000	35000	mcd
Dominant wavelength	λ_d	$I_F=50mA$	515	520	525	nm
Viewing Angle		$I_F=50mA$	---	30	---	deg
Thermal Resistance.	R_{THJ-S}	$I_F=50mA$	---	---	180	K/W

Table 1-2 Absolute Maximum Ratings at Ts=25°C

Parameter	Symbol	Rating	Units
Power Dissipation	P_D	210	mW
Forward Current	I_F	60	mA
Peak Forward Current	I_{FP}	100	mA
Reverse Voltage	V_R	5	V
Electrostatic Discharge (HBM)	E_{SD}	2000	V
Operating Temperature	T_{OPR}	-40 ~ +100	
Storage Temperature	T_{STG}	-40 ~ +100	
Junction Temperature	T_J	120	



Notes

- 1/10 Duty cycle, 10ms pulse width.
- The above forward voltage measurement allowance tolerance is $\pm 0.1V$.
- The above color coordinates measurement allowance tolerance is ± 0.005 . \pm
- The above luminous intensity measurement allowance tolerance $\pm 10\%$.
- Care is to be taken that power dissipation does not exceed the absolute maximum rating of the product.
- All measurements were made under the standardized environment of Refond.
- When the LEDs are in operation the maximum current should be decided after measuring the package temperature, junction temperature should not exceed the maximum rate
- ESD yield is over 90% at 2000V ESD (HBM). ESD protection during products handing is needed.

1.6Bin Range Of Forward Voltage and Luminous Intensity and Dominant wavelength (IF=50mA) BIN (IF=50mA)

Table 1-3

V _F	G2	H1	H2	I1	I2	J1
	2.9-3.0	3.0-3.1	3.1-3.2	3.2-3.3	3.3-3.4	3.4-3.5
IV	S1	S2	T1	T2		
	15000-18000	18000-23000	23000-28000	28000-35000		
WD(nm)	D10	D20	E10	E20		
	515-517.5	517.5-520	520-522.5	522.5-525		





1.7 Typical Optical Characteristics Curves

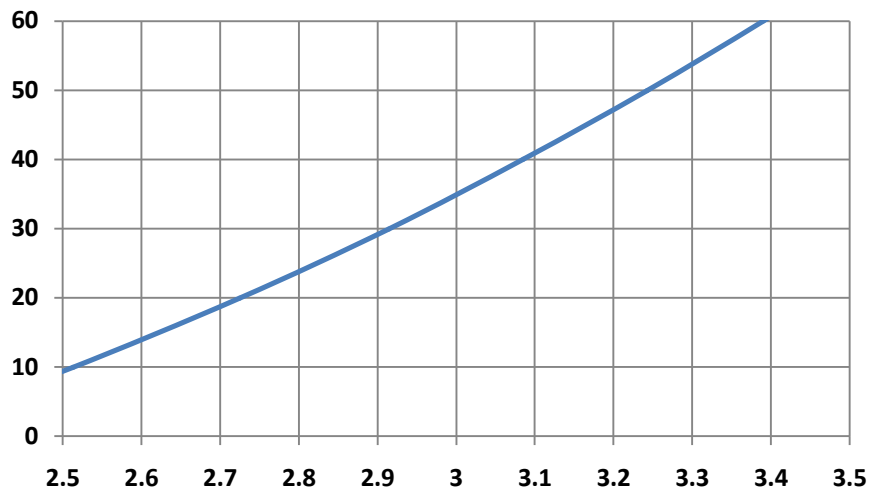

Fig. 1-7 Forward Voltage Vs Forward Current

Fig. 1-8 Forward Current Vs Relative Intensity

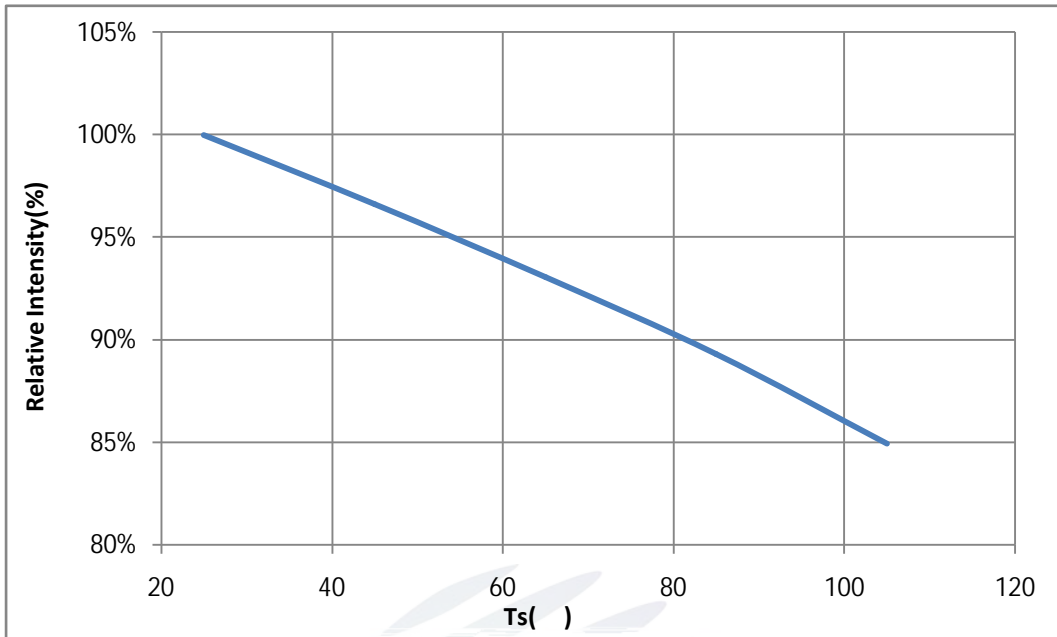

Fig. 1-9 Solder Temperature Vs Relative Intensity

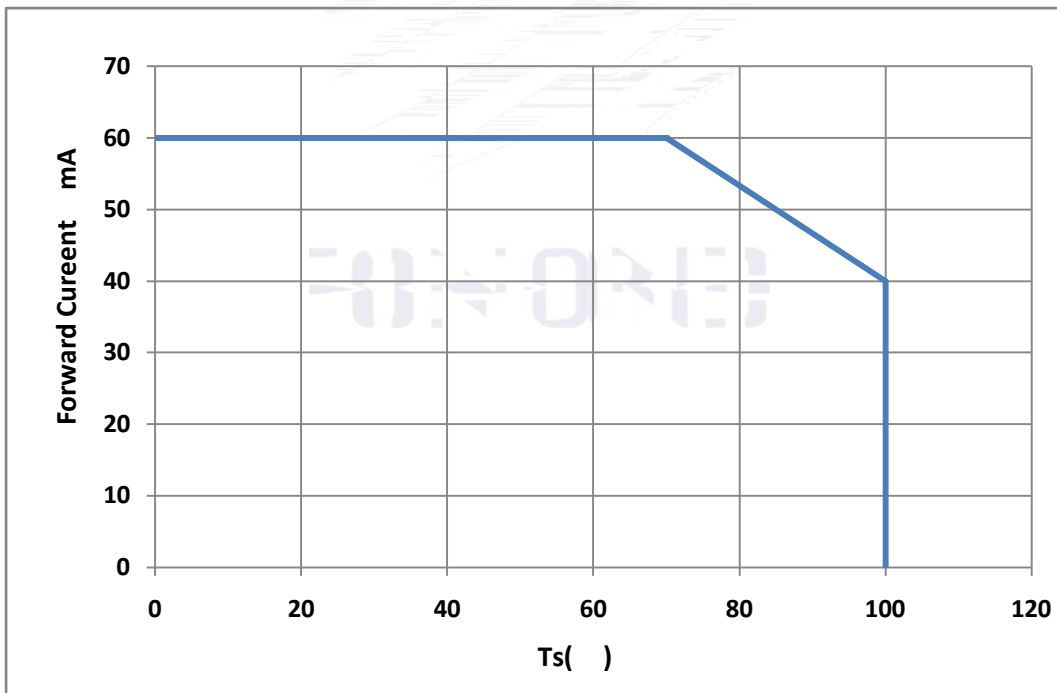

Fig. 1-10 Solder Temperature Vs Forward Current



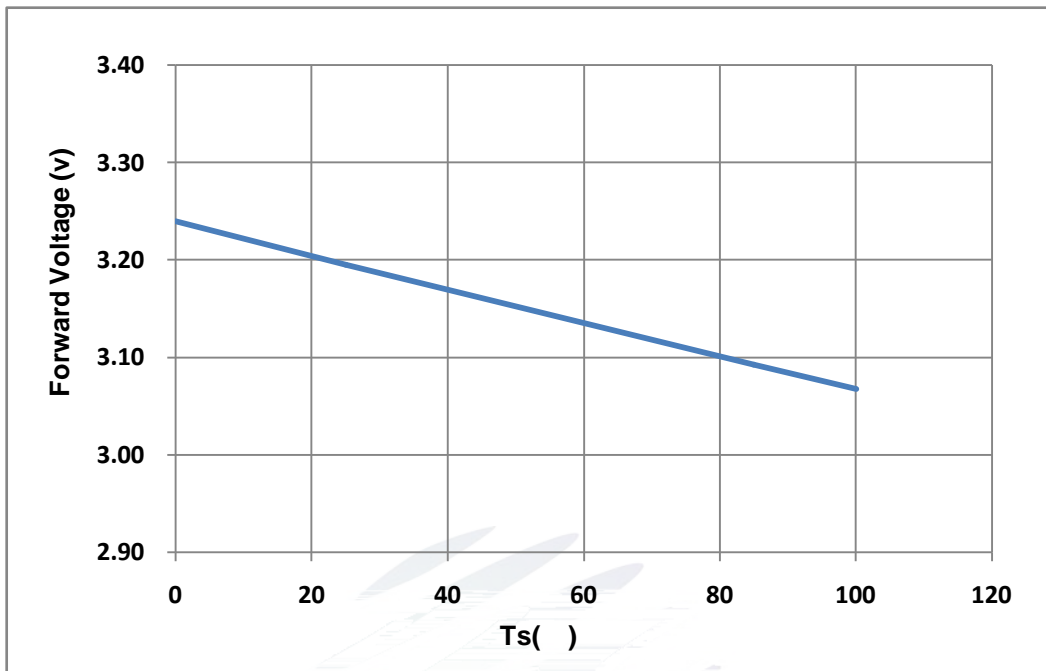

Fig. 1-11 Forward Voltage Vs Solder Temperature

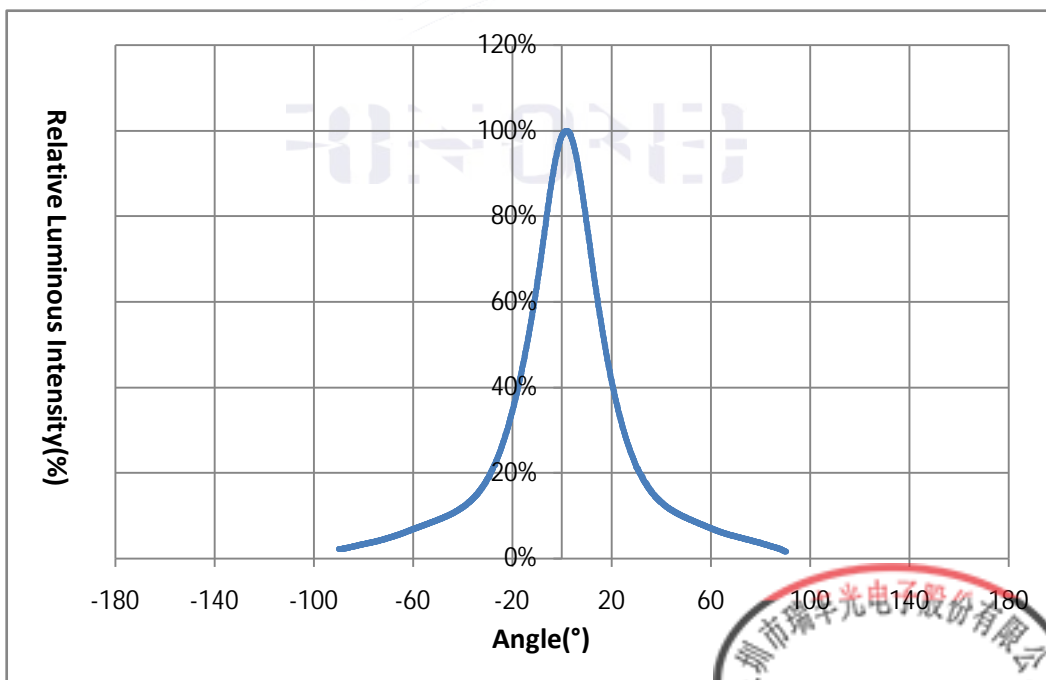

Fig. 1-12 Radiation diagram



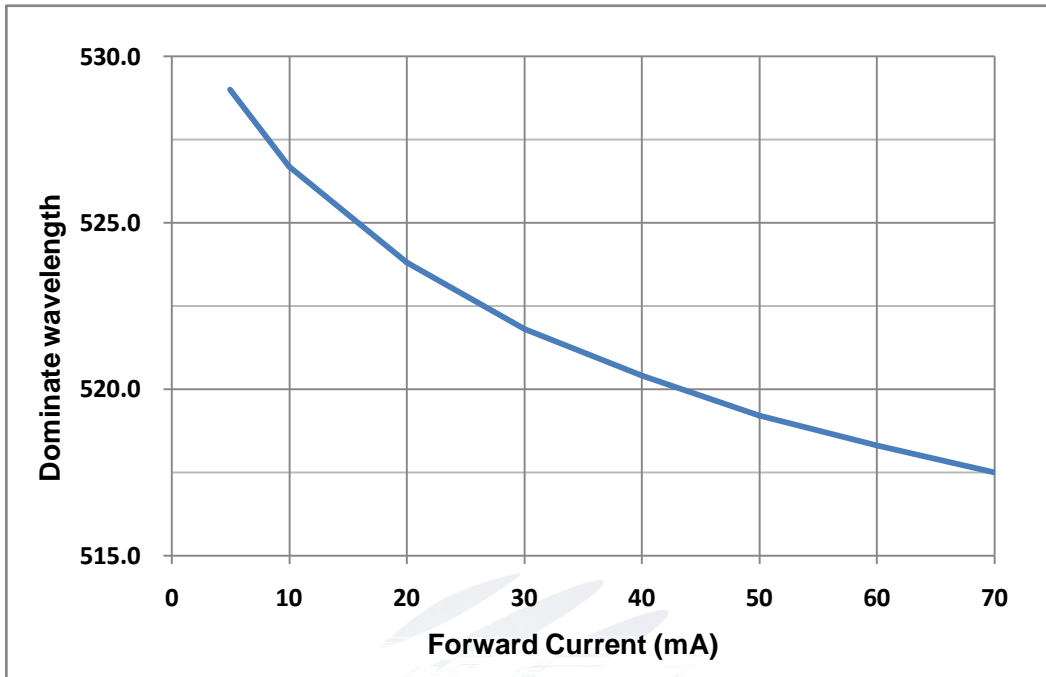

Fig. 1-13 Forward current vs. Dominate wavelength (Ts=25°C)

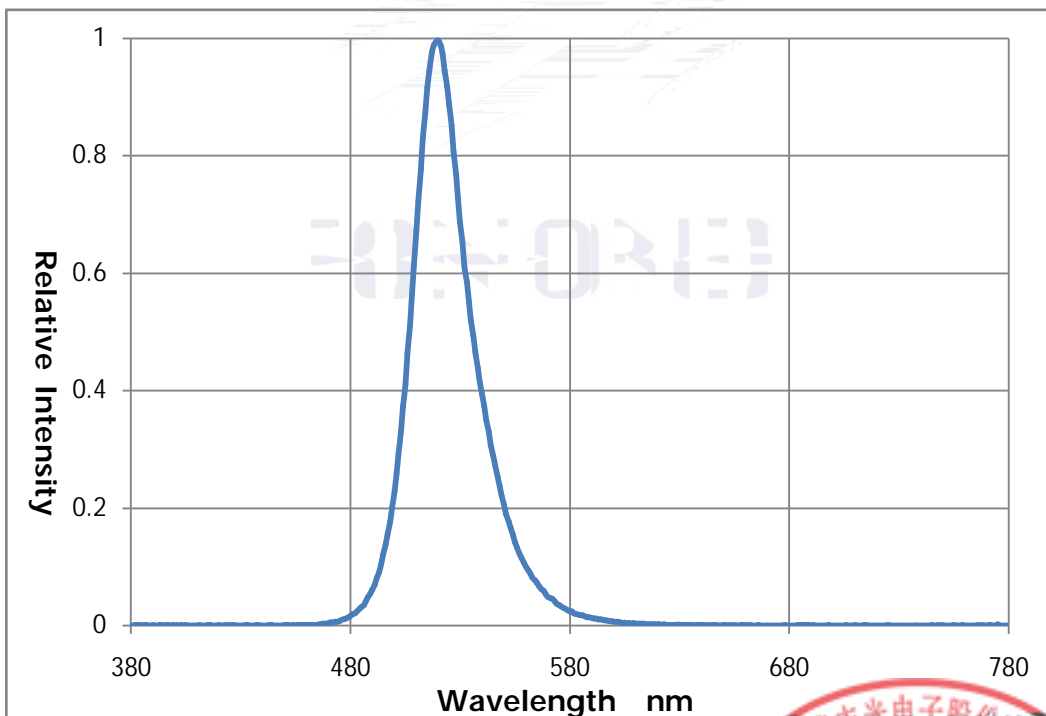

Fig. 1-14 Spectrum Distribution





2. Packaging

2.1 Packaging Specification

Package:2000pcs/reel. 2000pcs

2.1.1 Carrier Tape Dimension

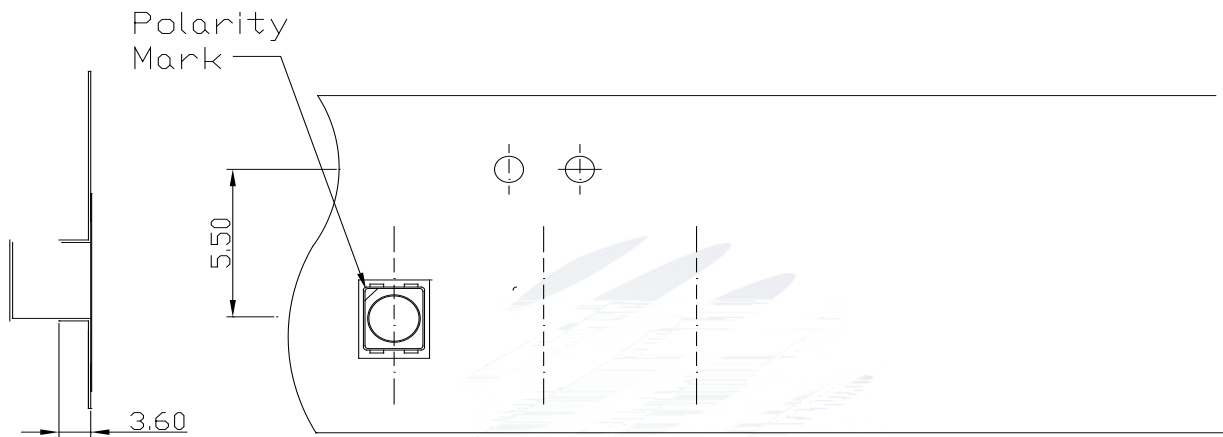



2.1.3 Label Form Specification

Specification

PART NO.	Part Number
SPEC NO.	Spec Number
LOT NO.	Lot Number
BIN CODE	Bin Code
	Luminous flux
XY	Chromaticity Bin
V _F	Forward Voltage
WLD	Wavelength
QTY	Packing Quantity
DATE	Made Date

Fig. 2-3 Label

2.2 Moisture Resistant Packing

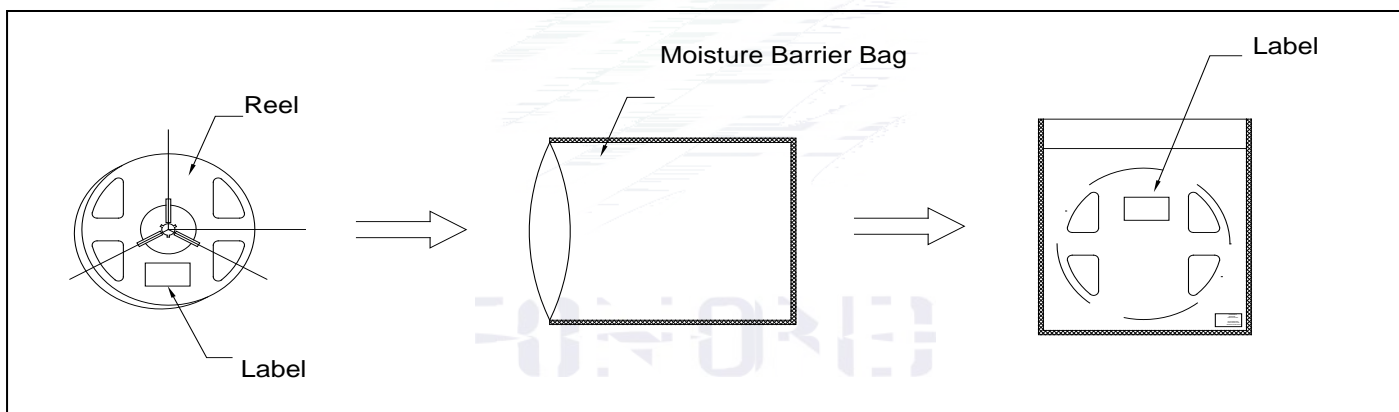

Fig.2-4 Moisture Resistant Packing

2.3 Cardboard Box

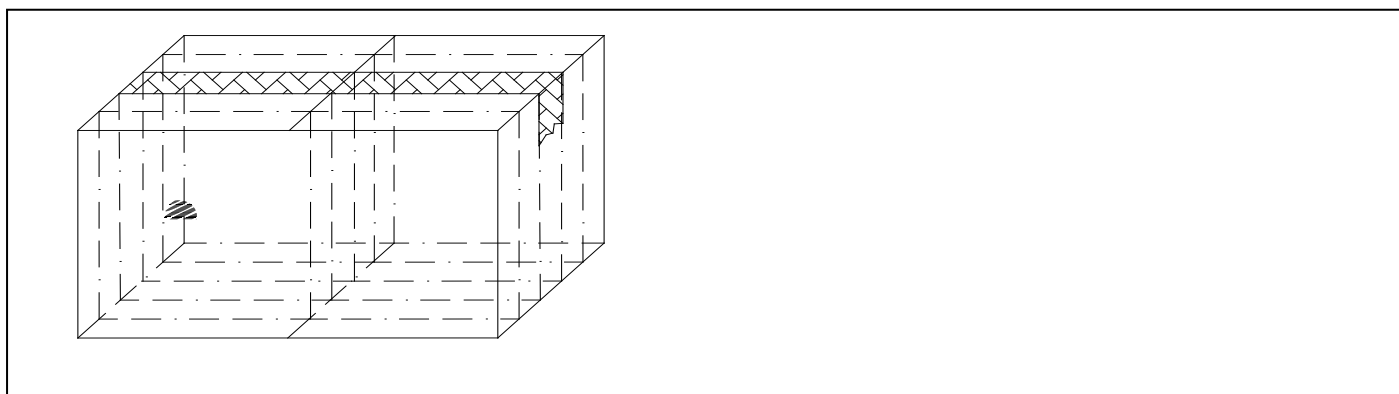

Fig.2- Cardboard Box



2.4 Reliability Test Items And Conditions

Table 2-3 Reliability Test Items And Conditions

Test Items	Ref.Standard	Test Condition	Time	Quantity	Ac/Re /
Reflow	JESD22-B106	Temp:260 max T=10 sec	2times	20pcs.	0/1
MSL2 2	JESD22-A113	85 / 60%RH	168 hrs.	20pcs.	0/1
Thermal Shock	JEITAED-4701 300307	-40 15min 10s 125 15min	1000 cycle	20pcs.	0/1
Life Test	JESD22-A108	Ta=100 If=50mA	1000hrs.	20pcs.	0/1
High Temperature High Humidity Life Test	JESD22-A101	85 / 85%RH If=50mA	1000hrs.	20pcs.	0/1





2.5 Criteria For Judging Damage

Table 2-4 Criteria For Judging Damage

Test Items	Symbol	Test Condition	Criteria For Judgement	
			Min.	Max.
Forward Voltage	V_F	$I_F=50mA$	-	U.S.L*)x1.1





3. SMT Reflow Soldering Instructions SMT

3.1 SMT Reflow Soldering Instructions SMT

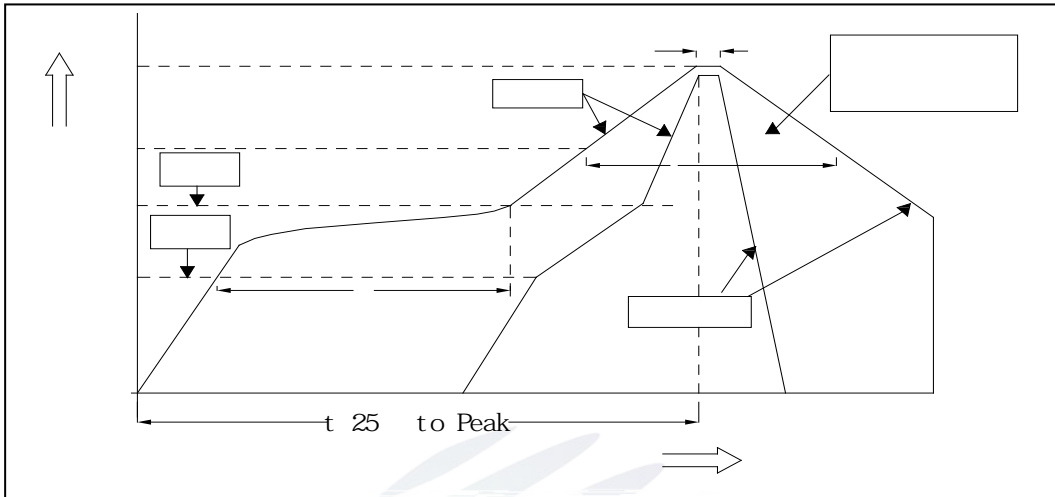
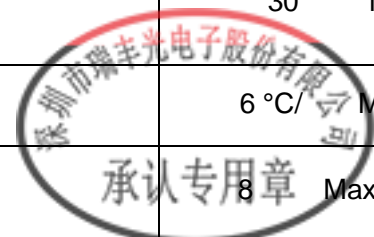

Fig.3-1 SMT Reflow Soldering Instructions SMT

Table 3-1 Reflow parameters

Average temperature rise speed	T_{smax} T_P	3 °C/ s	Max 3 °C/ s
Preheating: minimum temperature	(T_{smin})	150 °C	
Preheating: Max temperature	(T_{smax})	200 °C	
Preheating: Time	T_{smin} T_{smax}	60 - 120	60s-120s
Time limited to maintain high temperature: the temperature	(T_L)	217 °C	
Time limited to maintain high temperature: The Time	(t_L)	60	Max 60s
Peak /Classification of temperature:	(T_P)	260 °C	
Time limit classification of peak temperature time	t_p	10	Max 10s
actual peak temperature (T_P)	5 °C Hold time within 5 °C with the	30	Max 30s
Cooling speed		6 °C/ s	Max 6 °C/ s
25 °C	Needed time from 25 °C to T_p	8	Max 8 minutes





Notes

(1)Reflow soldering should not be done more than twice. If more than 24 hours between the two solderings ,LED will be damaged.

(2)When soldering , do not put stress on the LEDs during heating.

3.1.1 Soldering Iron

(1) When do soldering by hand, keep the temperature of iron below less 300 less than 3 seconds.

, 300 3

(2) Soldering by hand should be done only one time.

3.1.2 Repairing

Repairing should not be done after the LEDs have been soldered. When repairing is unavoidable,a double-head soldering iron should be used (as below figure). It should be confirmed in advance whether the characteristics of LEDs will or not be damaged by repairing.

LED

LED

3.1.3 Cautions

(1) The encapsulated material of the LEDs is silicone. Therefore the LEDs have a soft surface on the top of package. The pressure to the top surface will be impacted on the reliability of the LEDs. Precautions should be taken to avoid the strong pressure on the encapsulated part. So when use the picking up nozzle, the pressure on the silicone resin should be proper. LED LED

(2) Components should not be mounted on warped (non coplanar) portion of PCB. After soldering, do not warp the circuit board.LED PCB

(3) Do not apply mechanical force or excess vibration during the cooling process to normal temperature after soldering. Do not rapidly cool device after soldering.





4. Handling Precautions

4.1 Handling Precautions

(1) LED operating environment and sulfur element composition cannot be over 100PPM in the LED mating usage material. This is provided for informational purposes only and is not a warranty or endorsement.

LED	100PPM.
-----	---------

(2) In order to prevent external material from getting into the inside of LED, which may cause the malfunction of LED, the single content of Bromine element is required to be less than 900PPM, the single content of Chlorine element is required to be less than 900PPM, the total content of Bromine element and Chlorine element in the external materials of the application products is required to be less than 1500PPM. This is provided for informational purposes only and is not a warranty or endorsement.

LED	LED
900PPM	900PPM
1500PPM.	

(3) VOCs (Volatile organic compounds) emitted from materials used in the construction of fixtures can penetrate silicone encapsulants of LEDs and discolor when exposed to heat and photonic energy. The result can be a significant loss of light output from the fixture. Knowledge of the properties of the materials selected to be used in the construction of fixtures can help prevent these issues. Refond advises against the use of any chemicals or materials that have been found or are suspected to have an adverse affect on device performance or reliability. To verify compatibility,

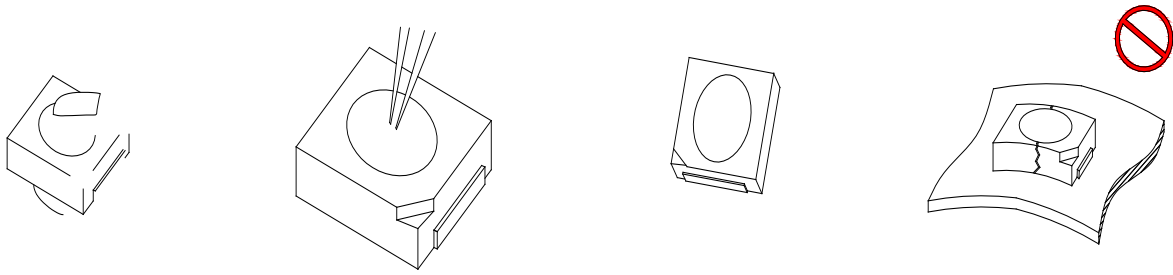

Fig 4-1 Handling Precautions

(5) In designing a circuit, the current through each LED can not exceed the absolute maximum rating specified for each LED. In the meanwhile, resistors for protection should be applied, otherwise slight voltage shift will cause big current change, burn out may happen. The driving circuit must be designed to allow forward voltage only when it is ON or OFF. If the reverse voltage is applied to LED, migration can be generated resulting in LED damage.

LED

LED

(6) Thermal Design is paramount importance because heat generation may result in the Characteristics decline, such as brightness decreased, Color change and so on. Please consider the heat generation of the LEDs when making the system design.

LED

(7) Compared to standard encapsulants, silicone is generally softer, and the surface is more likely to attract dust, requiring special care during processing. In cases where a minimal level of dirt and dust particles cannot be guaranteed, a suitable cleaning solution must be applied to the surface after the soldering of components. Refond suggests using isopropyl alcohol for cleaning. In case other solvents are used, it must be assured that these solvents do not dissolve the package or resin. Ultrasonic cleaning is not recommended. Ultrasonic cleaning may cause damage to the LED.

LED



Table 4-1 Storage

Conditions		Temperature	Humidity	Time
Storage	Before Opening Aluminum Bag	30	75%	Within 1 Year From Date
	After Opening Aluminum Bag	30	60%	Recommended for use within 24 hours 24
Baking		60 ± 5	-	24hours 24

(8) If the moisture absorbent material silica gel has faded away or the LEDs have exceeded the storage time, baking treatment should be performed after unpacking and based on the following condition 60±5 for above 24 hours.

60±5 24

If the package is flatulence or damaged, please notify the sales staff to assist.

(9) Similar to most Solid state devices; LEDs are sensitive to Electro-Static Discharge (ESD) and Electrical Over Stress (EOS). LED

(10) Other points for attention, please refer to our relevant information.



