

±

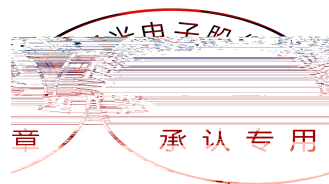

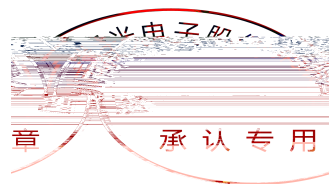

	λ					



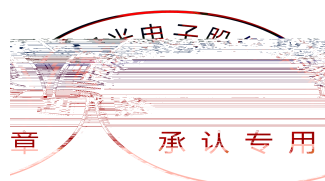

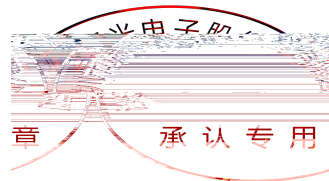
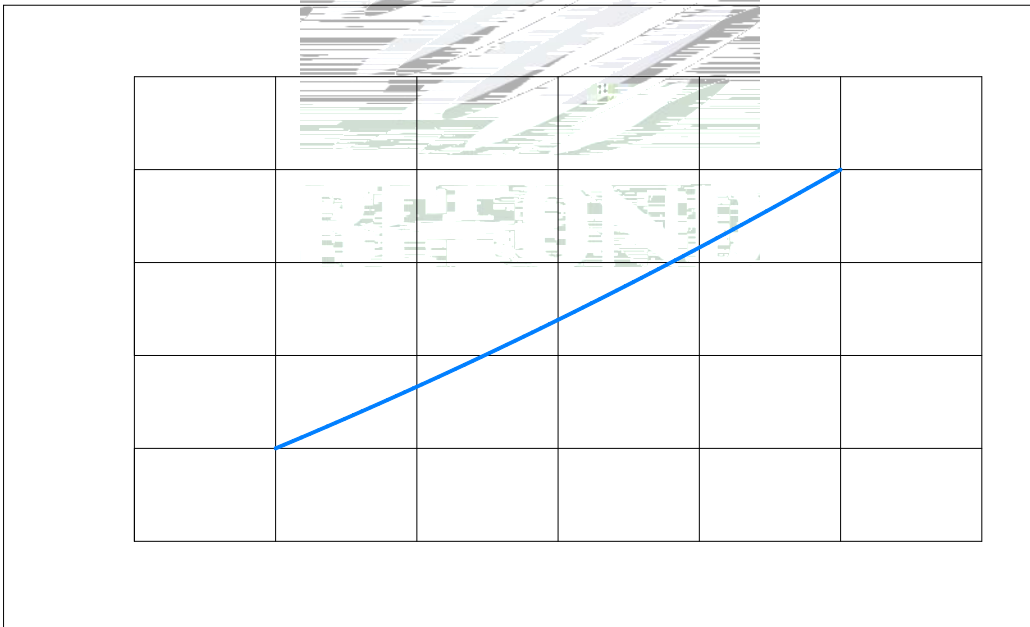
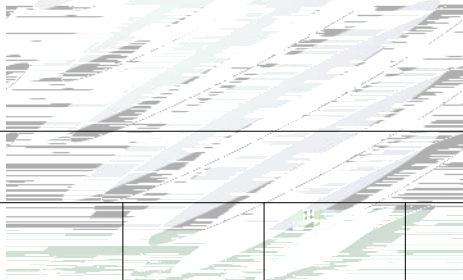
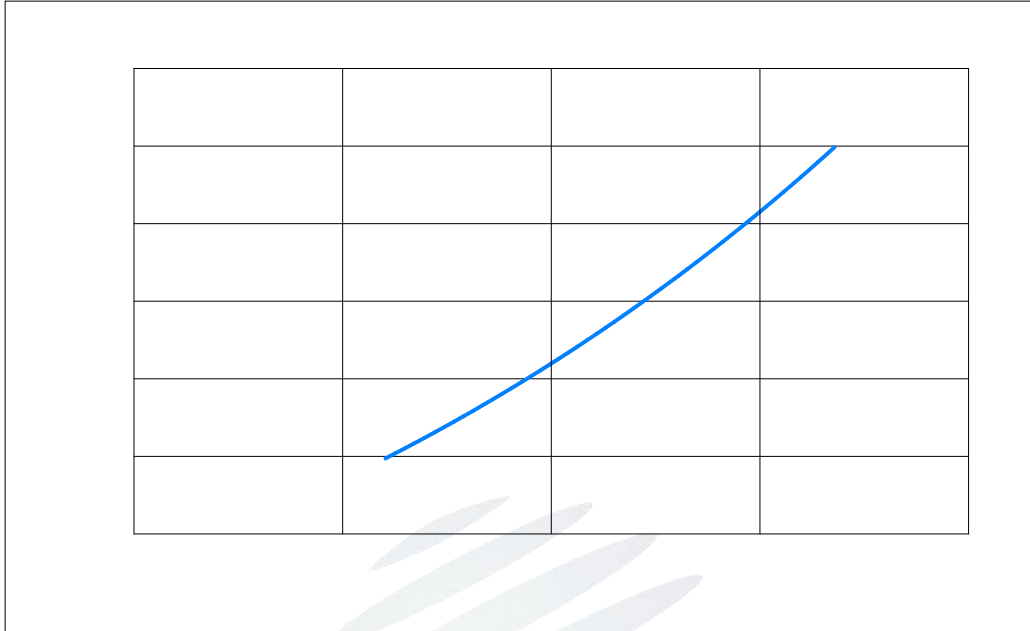

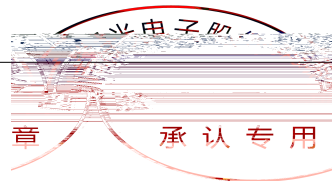
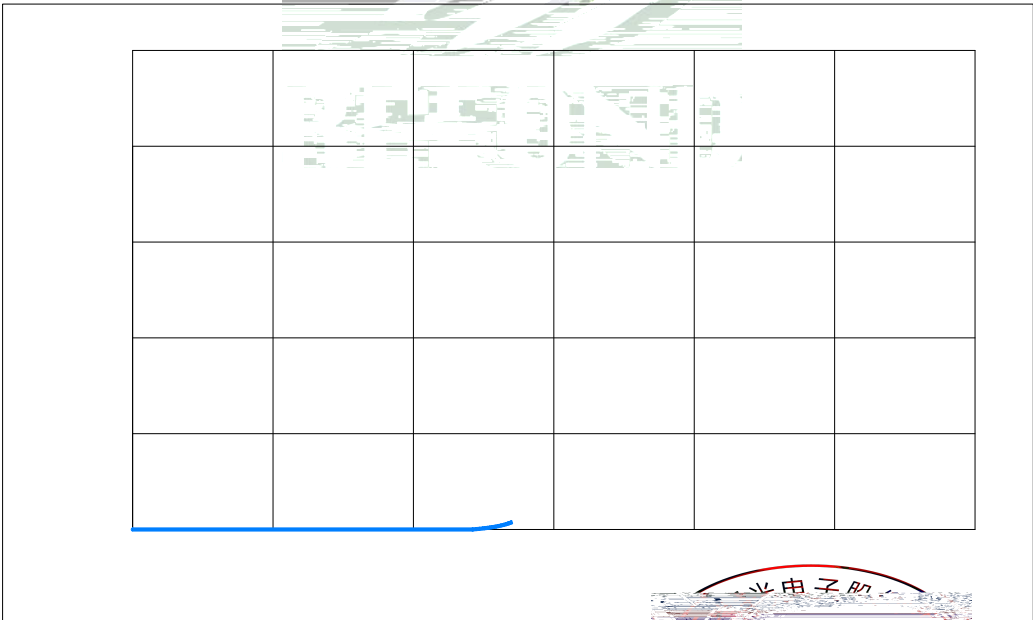
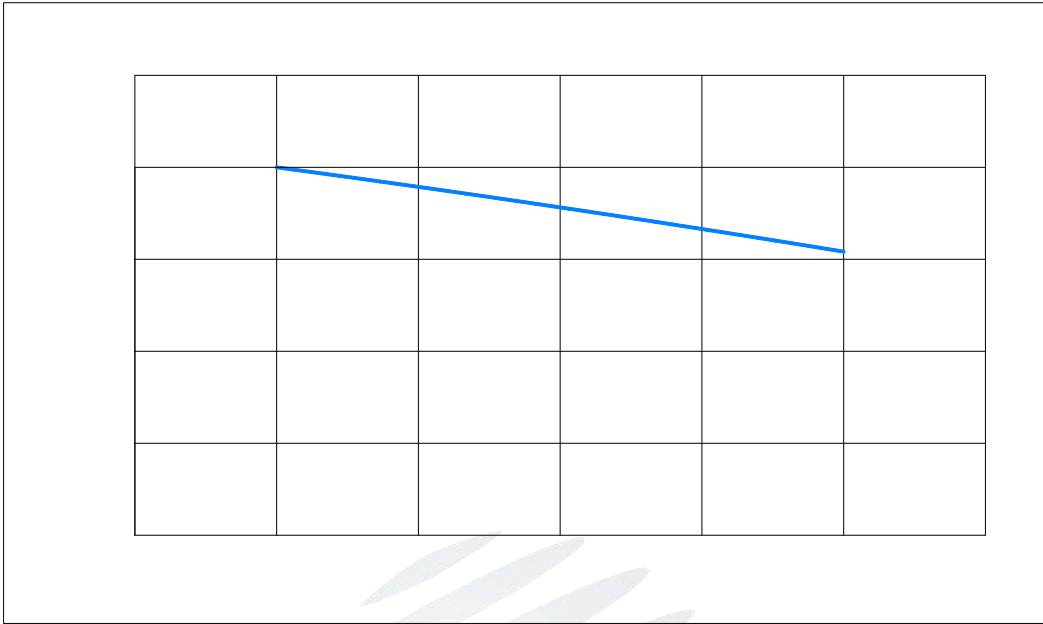

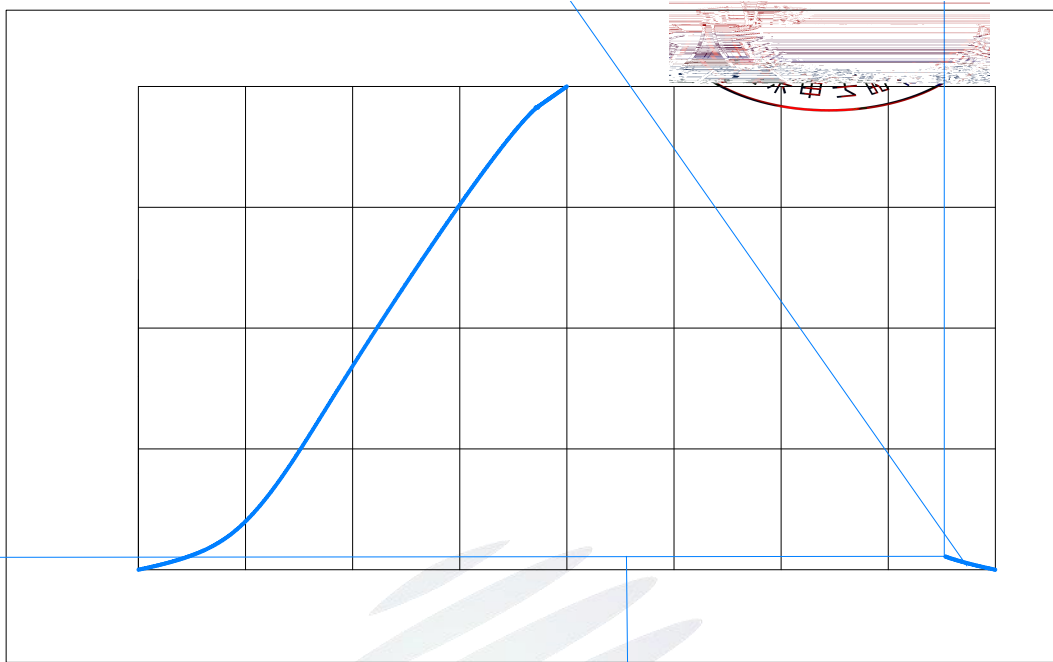

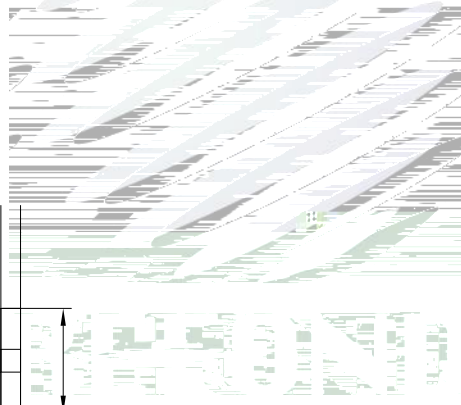
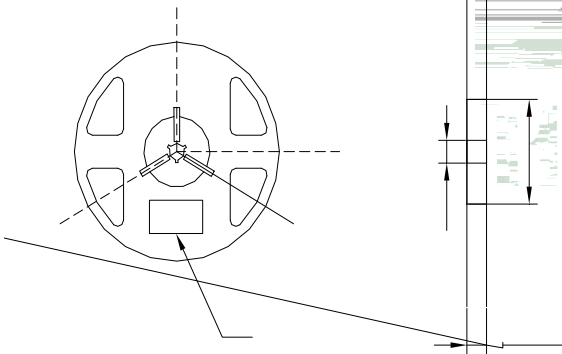
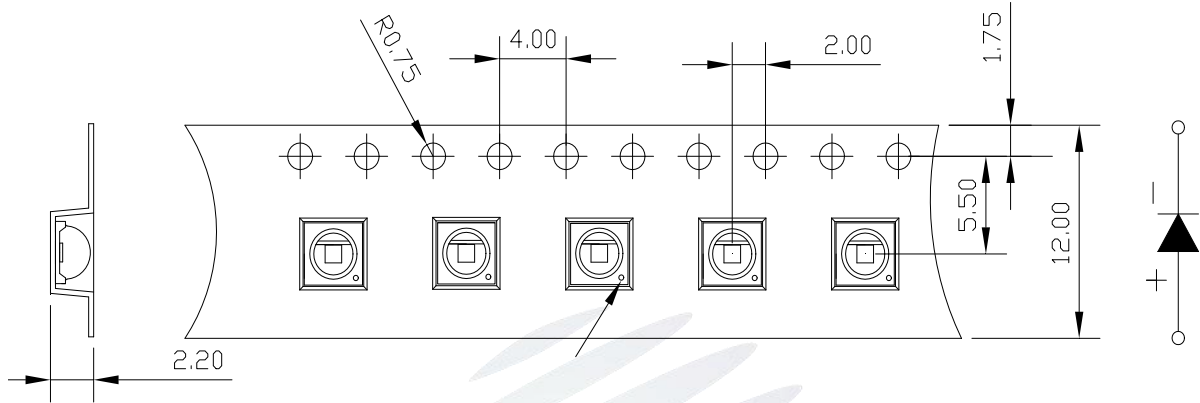
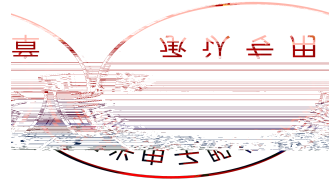

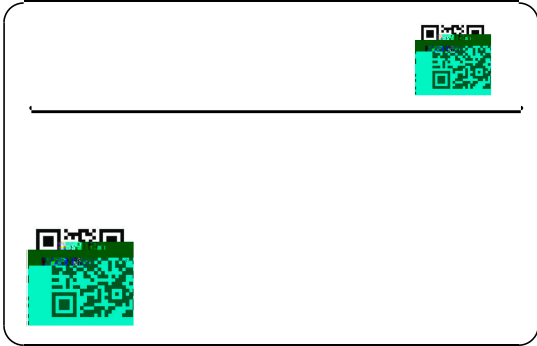

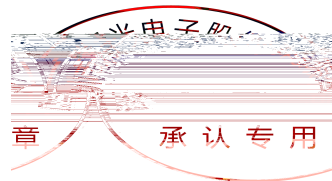
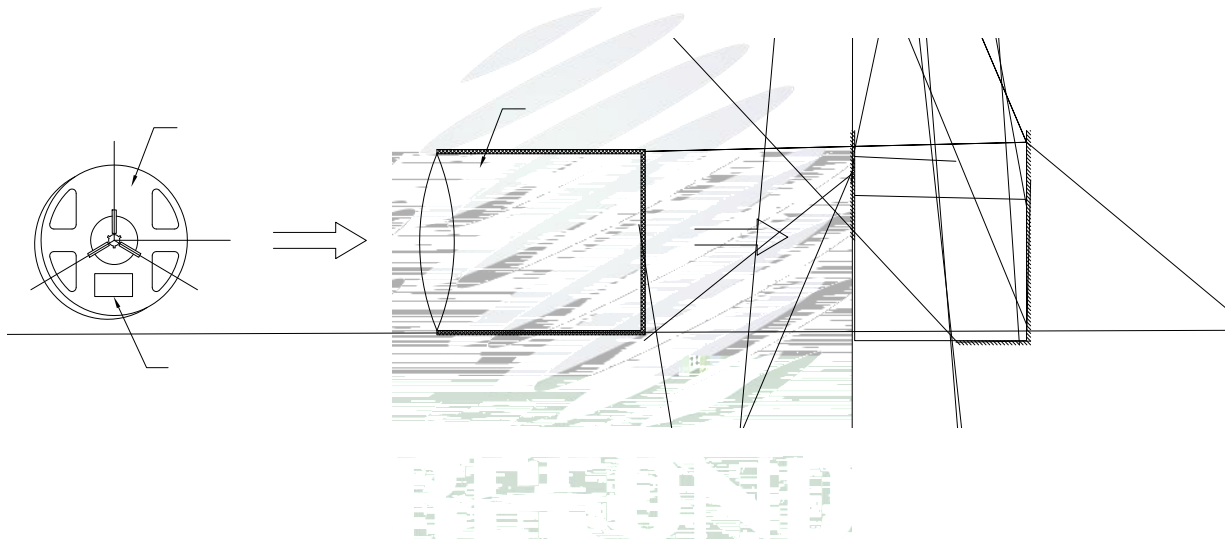



瑞豐光電

REUFENG OPTOELECTRONICS

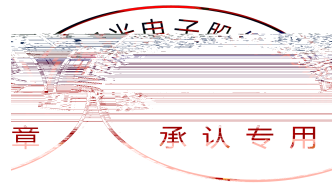
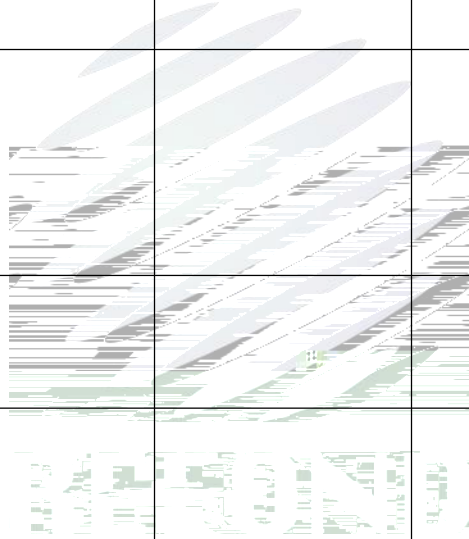



瑞豐光電

REDFENG OPTOELECTRONICS

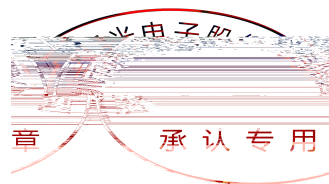



瑞豐光電

INTEGRATED OPTOELECTRONIC SOLUTIONS





瑞豐光電

REUFENG OPTOELECTRONICS

°C

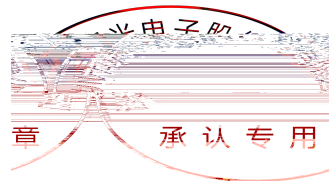

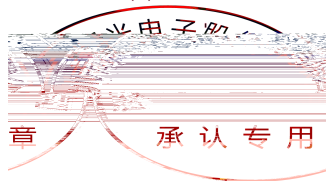
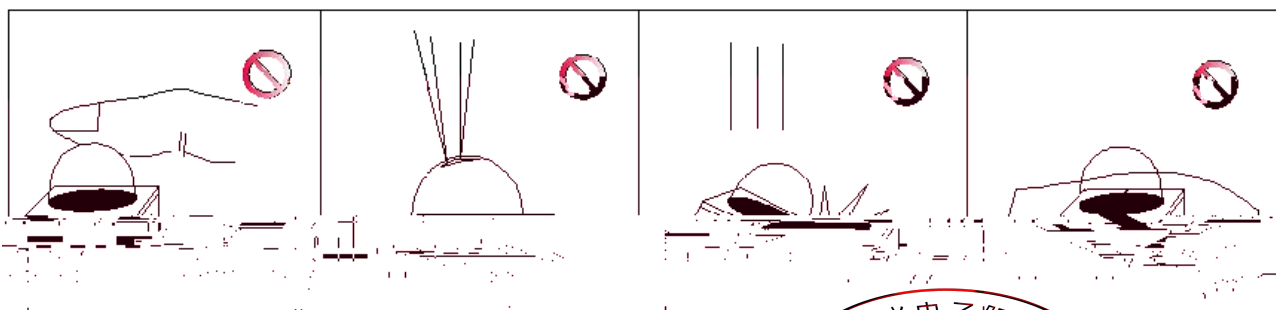



瑞豐光電

REUFENG OPTOELECTRONICS



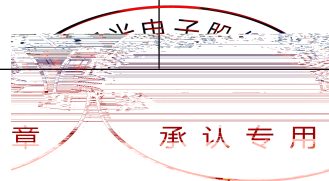

()

(±) °C

