

# SPECIFICATION

# 产品规格书

REFOND P/N 产品型号

RF-W1SA28IS-A43

R&D 研发

Mass Product 量产供货

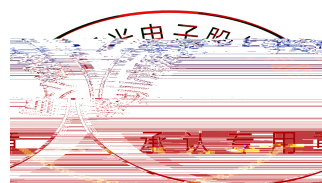

## Contents 目錄

- 1. Description 产品介绍
- 1.1 General Description 产品描述
- 1.2 Features 产品特征
- 1.3 Application 产品应用

4.1.5 Others 其它事项 .....20

4.1.6 Declare 申明.....20

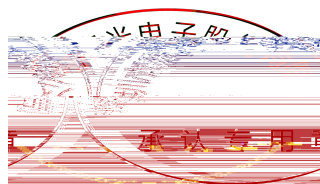

## 1. Description 产品介绍

### 1.1 产品描述

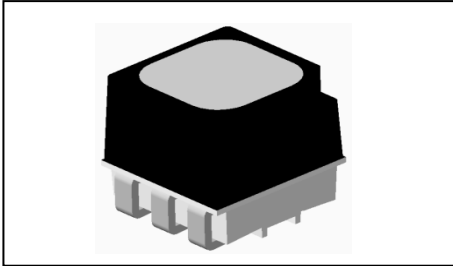

The product is a full-color LED device, High contrast(Surface brush design ). The product size: 2.8mmx2.7mmx2.45mm.

该产品为全彩 LED 器件，高对比度(表面刷墨设计)，产品尺寸: 2.8mmx2.7mmx2.45mm。

### 1.2 Features 产品特征

Surface not reflective. 表面不反光

High luminous Intensity, Low power dissipation, Good reliability and Long life.

光强高、功耗低、可靠性好、寿命长

Water-resistant(IPX6): 防水等级(IPX6)

Moisture sensitivity level: 5a. 潮湿敏感等级:5a

RoHS compliant. 满足RoHS要求

Matte surface. 哑光表面

Pb-free reflow soldering application. 无铅回流焊

### 1.3 Application 产品应用

Outdoor full-color video screen. 户外全彩显示屏

The automobile dashboard. 汽车仪表盘

Indoor and outdoor decorative lighting. 室内外装饰照明

Amusement. 娱乐产品

General use. 其他应用

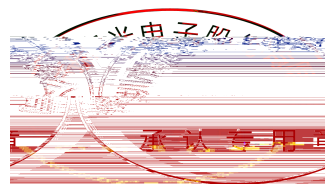

## 1.4 Package Dimension 封装尺寸

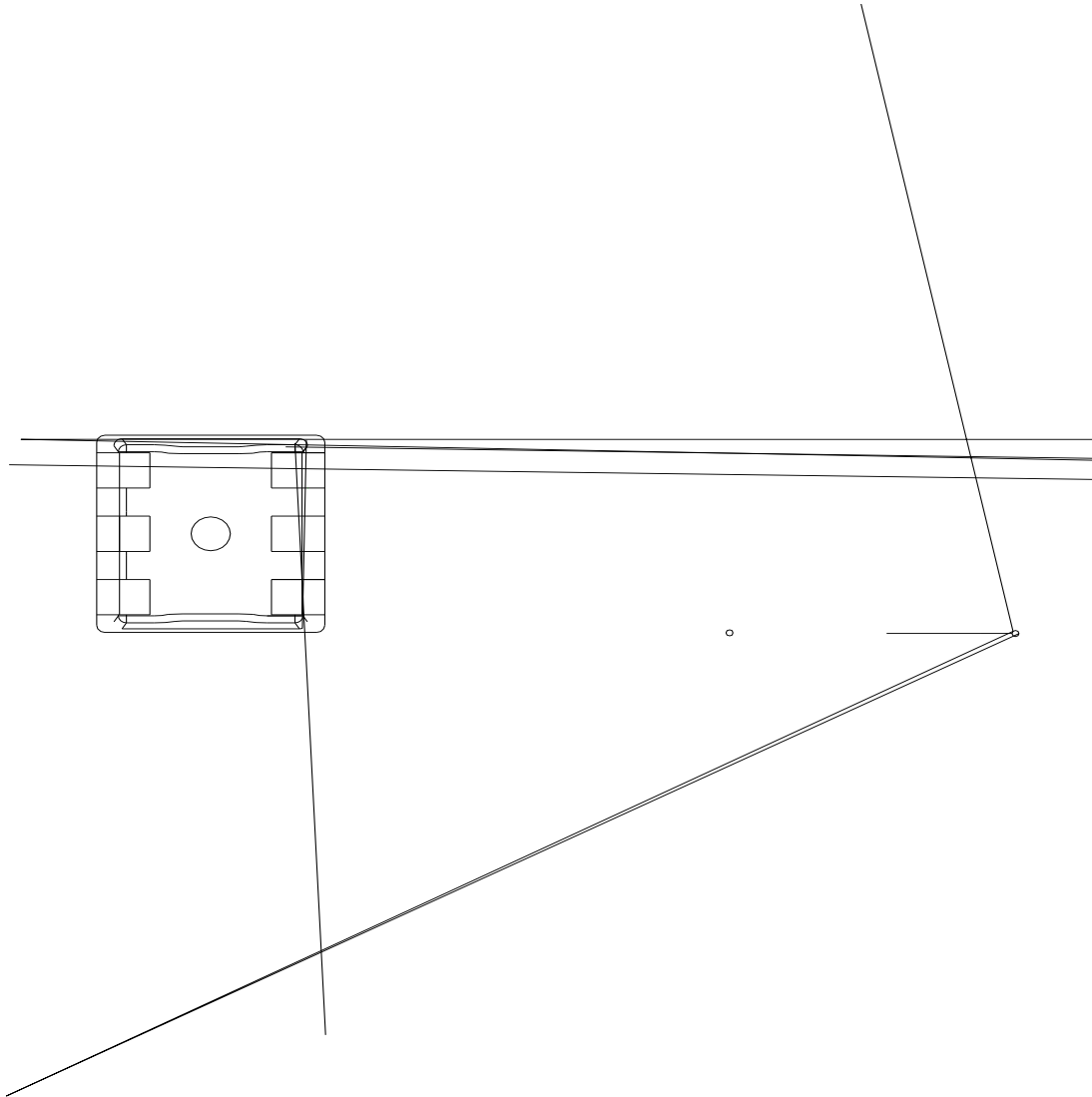

### Notes 备注:

1. All dimensions units are millimeters. 所有尺寸标注单位为毫米
2. All dimensions tolerances are  $\pm 0.1\text{mm}$  unless otherwise noted. 除特别标注外, 所有尺寸公差为 $\pm 0.1$  毫米

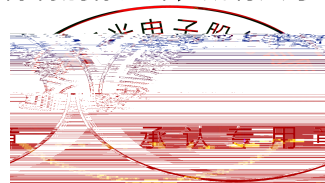

## 1.5 Product Parameters 产品参数

Table 1-1 Electrical / Optical Characteristics at Ts=25°C 电性与光学特性

Item 项目	Symbol 符号	Test Condition 测试条件	Value			Unit 单位
			R	G	B	
Reverse Current (漏电流)	$I_R$	$V_R=5V$	6	6	6	
Forward Voltage (正向电压)	$V_F(\min)$	R $I_F = 20mA$ G $I_F = 20mA$ B $I_F = 20mA$	1.7	2.7	2.7	V
	$V_F(\max)$		2.4	3.4	3.4	V
Dominant Wavelength 主波长	$D$		618~628	518~530	464~474	nm
Spectrum Radiation Bandwidth 半波宽			24	38	30	nm
Continuous Intensity 光强	$I_{V(\min)}$					

Notes

1. 1/10 duty cycle, 0.1ms pulse width. 脉宽0.1ms,占空比1/10.

2. The forward voltage measurement allowance tolerance is ±10%.

The above measurement of dominant wavelength ±10%.

The above measurement of intensity at a distance of 10cm ±10%. 上述发光强度的测试允许公差为±10%.

The absolute maximum rating of the product. 使用率不能超过产品的最大值.

These measurements were made in the laboratory of Refond. 基于瑞丰现有的所有测试设备.

These parameters are just for reference. please refer to the label. 以上参数仅供参考,请以实物为准.

6. Typical optical characteristics

典型光学特性曲线

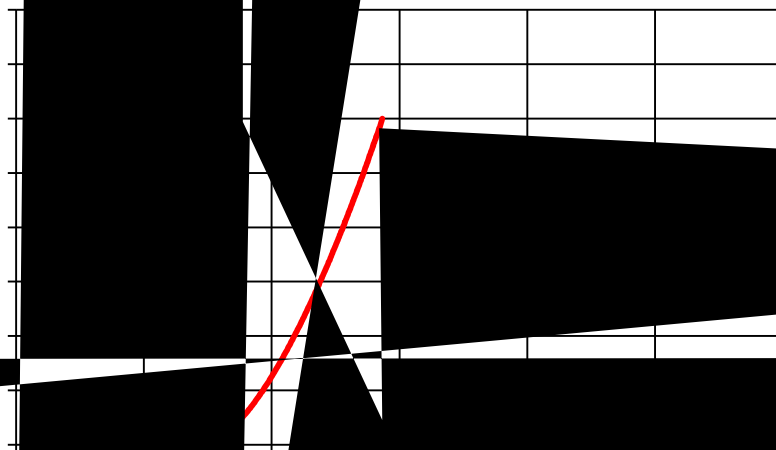

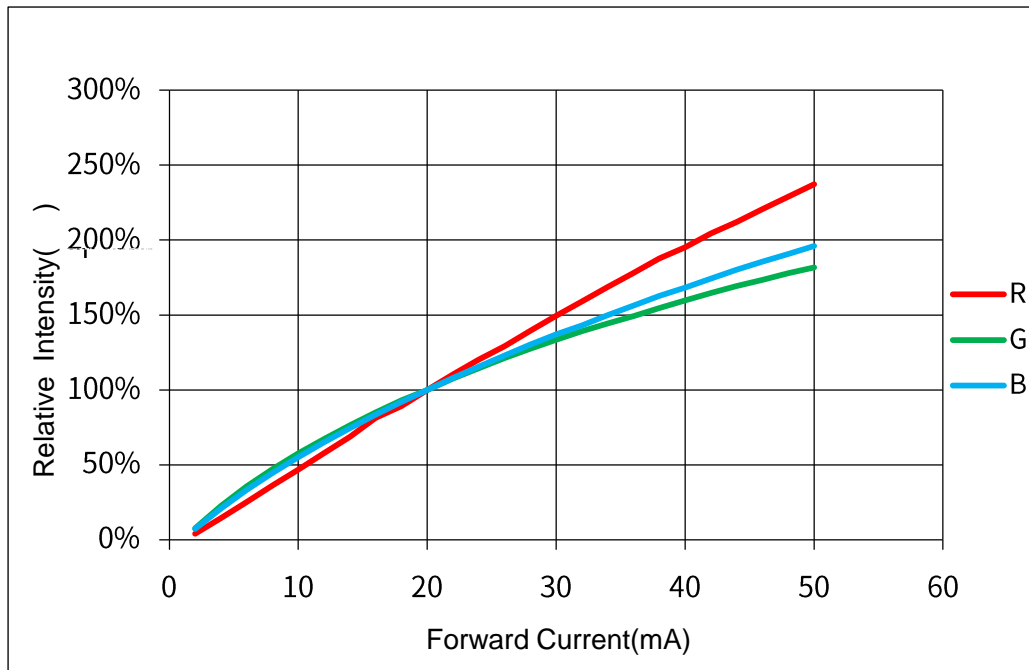

Fig 1-7 Forward Current Vs. Relative Intensity 正向电流与相对光强特性曲线

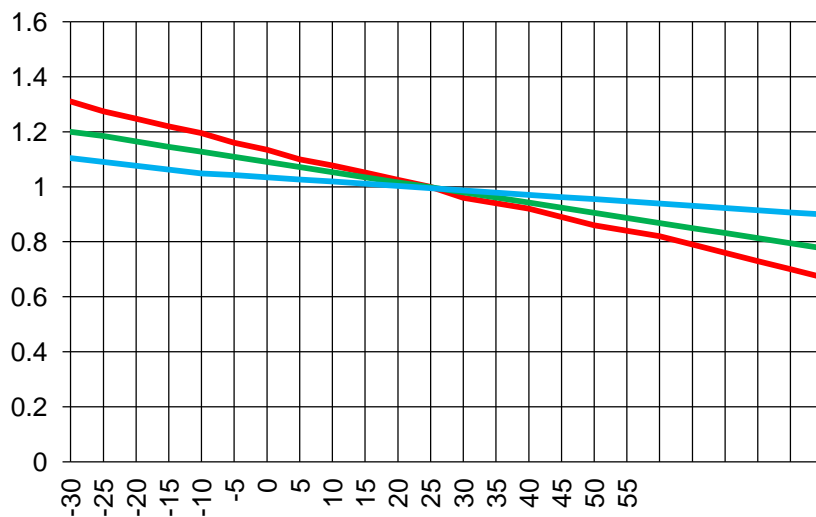

Fig 1-8 Luminous Intensity VS Ambient Temperature 光强与环境温度曲线



Fig 1-9 Solder Temperature Vs Forward Current

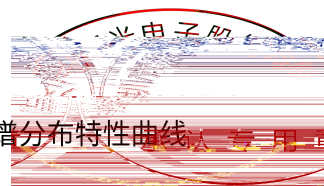
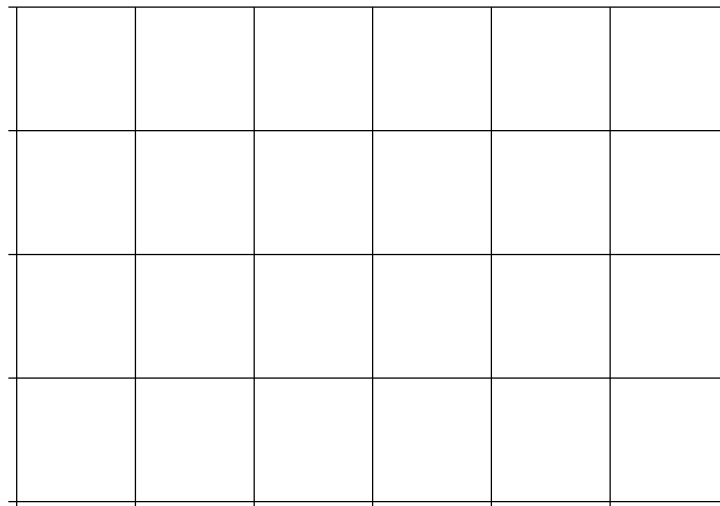

Fig 1-10 Spectrum Distribution 光谱分布特性曲线



## 2. Packaging 产品包装

### 2.1 Packaging Specification 包装规格

Package:3000pcs/reel.包装每卷 3000pcs。

#### 2.1.1 Carrier Tape Dimension 载带尺寸

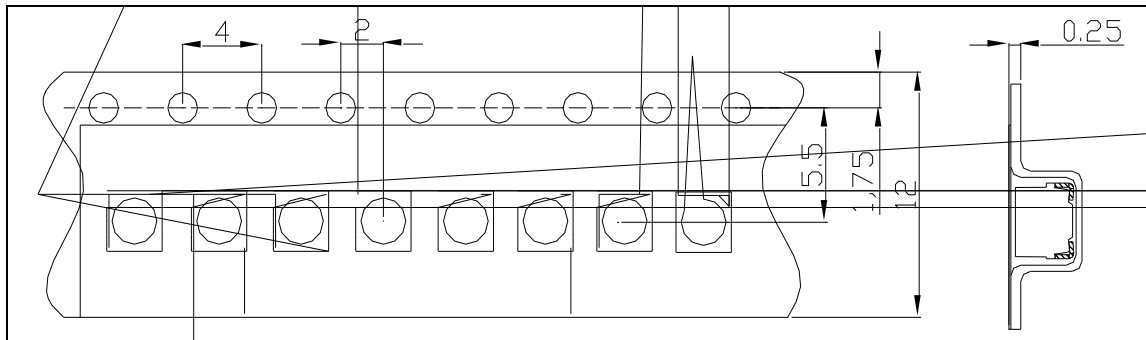

Fig.2-1 Carrier Tape Dimension 载带尺寸

#### 2.1.2 Reel Dimension 卷盘尺寸

Table 2-1 Title 表名

A	320.2±2mm
B	79.5±0.2mm
C	14.3±0.2mm
D	2.5±0.2mm
E	15.5±0.2mm
F	12.7±0.3mm
T	2.0±0.2mm

Fig.2-2 Title 图名

Notes 备注:

The tolerances unless mentioned ±0.1mm. Unit : mm 注：未注公差为±0.1毫米，尺寸单位：毫米。

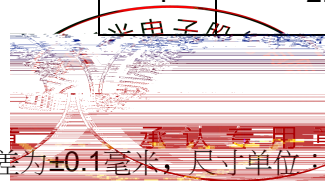

### 2.1.3 Label Form Specification 标签规格

Table 2-2 Title 表名

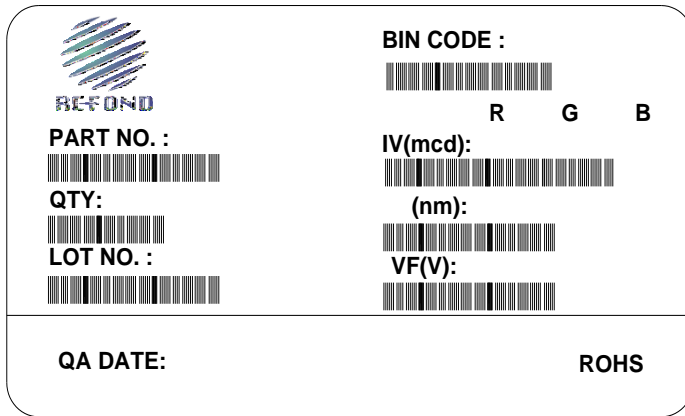

PART NO.	Part Number	品名
LOT NO.	Lot Number	批次号
BIN CODE	Bin Code	参数代码
IV	Llight intensity	光强
VF	Forward Voltage	正向电压
D	Wavelength	波长代码
QTY	Packing Quantity	数量
DATE	Made Date	生产日期

Fig 2-3 Title 图名

### 2.2 Moisture Resistant Packing 防潮包装

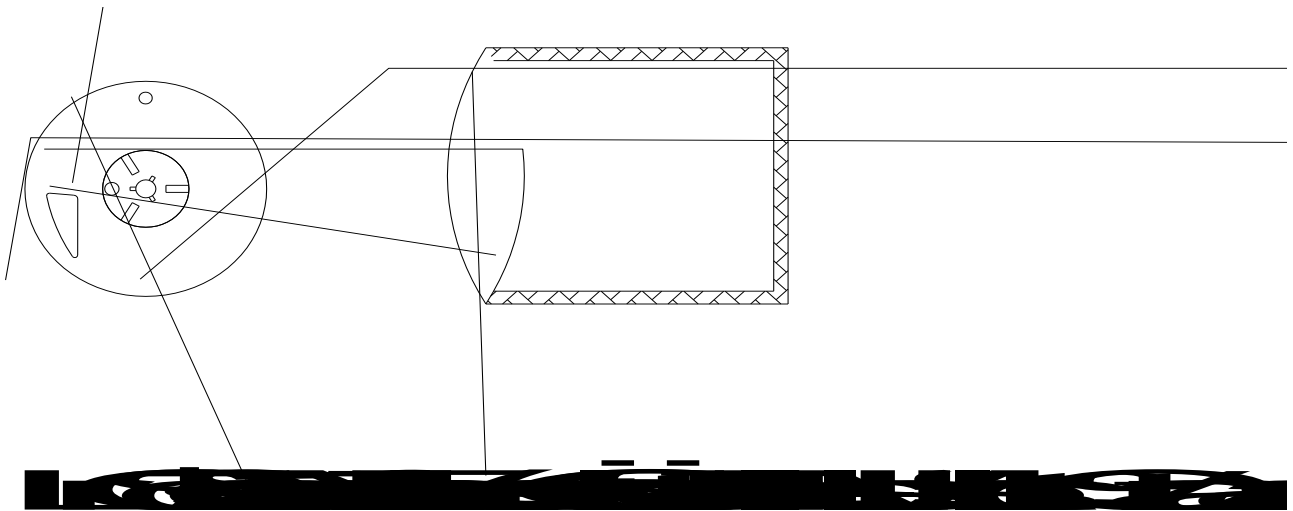
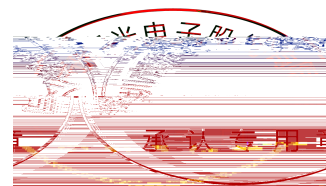

Fig.2- Title 图名



## 2.3 Cardboard Box 包装纸箱

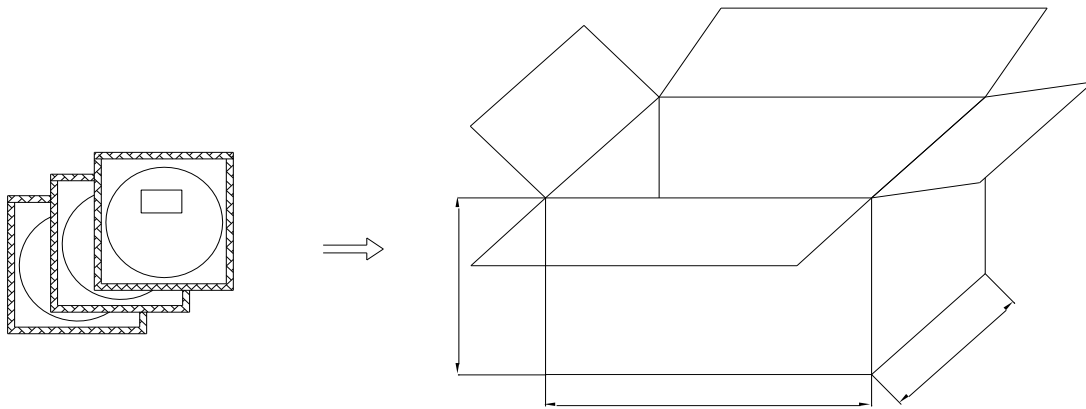

Fig.2- Title 图名

## 2.4 Reliability Test Items And Conditions 信赖性测试项目及条件

Table 2-3 Title 表名

Test Items 项目	Ref.Standard 参考标准	Test Condition 测试条件	Time 时间	Quantity 数量	Ac/Re 接收/拒收
Resistance to Soldering Heat 耐焊接热	JESD22-B106	Temp:260°Cmax T=10 sec	3times	22pcs.	0/1
Thermal Shock 冷热冲击	JEITAED-4701 300 307	-40°C 15min 10s 100°C 15min	500cycle	22pcs.	0/1
High Temperature Storage 高温保存	JEITAED-4701 200 201	Temp:100°C	1000hrs.	22pcs.	0/1
Low Temperature Storage 低温保存	JEITA ED-4701 200 202	Temp:-40°C	1000hrs.	22pcs.	0/1



Room Temperature Operating Life 常温寿命测试	JESD22-A108	$T_A=25^{\circ}\text{C}$ $I_F=20\text{mA}$	1000hrs.	22pcs.	0/1
High Temperature High Humidity Life Test 高温高湿寿命测试	JESD22-A101	$85^{\circ}\text{C}/85\%R_H$ $I_F=15\text{mA}$	500hrs.	22pcs.	0/1
Temperature Humidity Storage 高温高湿储存	JEITA ED-4701 100 103	$T_A=85^{\circ}\text{C}$ $R_H=85\%$	1000hrs.	22pcs.	0/1

Notes 备注:

1. The Reliability tests are based on Refond existing test platform. 可靠性测试基于瑞丰现有的测试平台。
2. The above reliability tests is based on the verification of a single/strip LED of Refond's existing experimental platform, the reliability experiment was taken under good heat dissipation conditions. when customers applies the LED to the series and parallel circuit, should take consideration of all the factors such as the current, voltage distribution, heat dissipation and others. 以上可靠性测试是基于瑞丰现有实验平台单颗/条 LED 在良好散热条件验证下的结果。客户端将 LED 应用于串、并联线路时，需自行评估电流、电压分配、散热等问题。
3. The technical information shown in the data sheets are limited to the typical characteristics and circuit examples of the referenced products. It does not constitute the warranting of industrial property nor the granting of any license. 以上技术数据仅为产品的典型值，只作为参考（以最终双方承认的规格为准），不作为任何应用条件及应用方式的保证。

### 3. SMT Reflow Soldering Instructions SMT 回流焊说明

#### 3.1 SMT Reflow Soldering Instructions SMT 回流焊说明

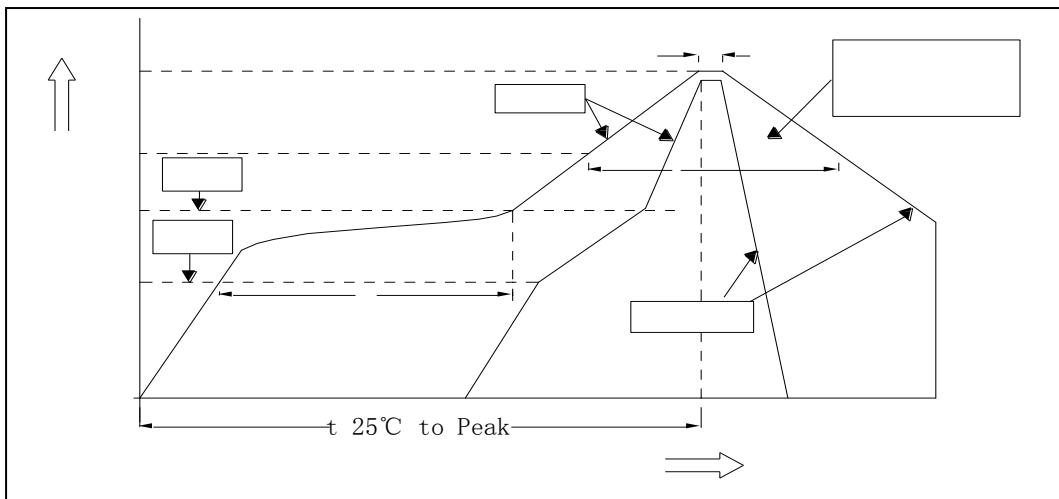
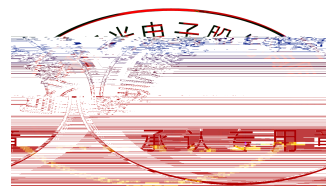

Fig.3-1 Title 图名









## 4.Handling Precautions 产品使用注意事项

### 4.1Handling Precautions 产品使用注意事项

#### 4.1.1 Storage 贮存

(1) Moisture proof and anti-electrostatic package with moisture absorbent material is used, Packaged products have one year to save time.

本产使用密封防潮抗静电袋包装,并附有干燥剂,未开封的产品保存时间一年.

(2) Before opening the package, the product should be kept at 30 or less and humidity less than 60%RH.

开封前,产品须存放在温度不高于30°C,湿度不高于60%RH的环境中.

(3) Seal anti-electrostatic bag humidity card should immediately check bag humidity indicator card in the open the bag after, Humidity is greater than or equal to 30%, Must be baked before use  
密封防静电袋内的湿度卡应在打开袋子后立即查看袋内的湿度指示卡来确定,湿度显示大于或等于30%时,使用前须进行烘烤.

(4) After opening the package, the product should be soldered within 24 hours. If not, please store at 30 or less and humidity less than 10%RH. It is recommended that the product be operated at the workshop condition of 30 or less and humidity less than 60%RH.

开封后,产品必须24小时内使用完(建议工作环境温度不高于30°C,湿度不高于60%),如未使用完,余料须存放在温度不高于30°C,湿度不高于10%的环境中.

(5) If the moisture absorbent material has fade away or the LEDs have exceeded the storage time, baking treatment should be performed based on the following condition : 65±5

将产品和外界之间的摩擦减到最低以避免静电产生。

(3) All production machinery and test instruments must be electrically grounded.

所有的产品设备和测试仪器必须接地。

(4) Operators must wear anti-static bracelets.

操作人员必须配戴静电环。

(5) Wear anti-static suit when entering work areas with conductive machinery.

进入带电设备工作区域需穿戴静电服。

(6) All workstations that handle IC and ESD-sensitive components must maintain an electrostatic potential of 150V or less.

所有操作 IC 和 ESD 敏感器件元器件的工作台必须保持低于 150V 的静电保护。

#### 4.1.3 Reverse voltage protection 反压保护

In generally the reverse current of LED is very small, it can't effect using the component normally, but when it often suffered the reverse voltage which exceed the limits of the component than it will be damaged, the reverse current increases rapidly causing the string light display gray scale so when designing, please pay attention to control the reverse voltage we suggest the reverse voltage less than 10V.

通常 LED 的反向漏电流都会很小,不会影响正常使用. 如果长期遭受超过其所能承受的反向电压冲击时,LED 会损伤,反向漏电流会迅速变大,引起显示屏零灰度下串光的发生. 在设计中,要注意控制反向电压,建议加在 LED 上的反向电压值不超过 10V.

#### 4.1.4 The safe temperature for LEDs working 温度保护

Luminous Intensity deceased radically, if LEDs worked in hot environment for a long time, they will be disabled easily. When LEDs are working in a closed surface temperature should be lower than 55 temperature should be lower than 75 .

LED 在高温条件下,衰减会加速,亮度也会下降. 若长期处于高温环境下,极容易出现失效. 对于高密度排列使用的情况,建议在使用过程中灯面温度不超过 55°C,灯脚温度不超过 75°C.

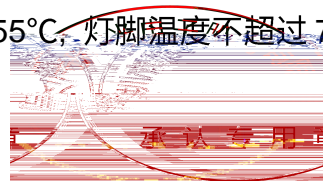

#### 4.1.5 Others 其它事项

Do not directly touch or handle the epoxy surface. It may damage the internal circuitry.

Handle the component along the side surfaces by using forceps or appropriate tools.

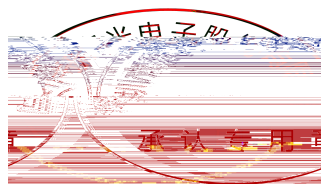





Declare 申明

This specification is written both in English and in Chinese and the latter is formal.

产品规格书以中英文方式书写，若有冲突以中文版本为准。

