

SPECIFICATION



Mass Product

Contents

1. LED Module Description	3
2.LED Module Specification	4
2.1 Optical-electrical Characteristics(Absolute Maximum Ratings At Ts=25)4
2.2 LED Module Schematic And Interface Definition	5
2.3 LED Module rule of naming	:	5
3. Product Specification	6
3.1 Outline Dimension	6
4.LED Module Reliability Test	7
5.LED Module Materials Performance Test And Method At Ta=25	8
6.Packing Criterion	9
6.1 Package Diagram /	9
6.2 Carton silk printing/	9
6.3Label Form Specification/	9
7. Handling Precautions	10



1. LED Module Description

LED Module designed according to the market mainstream of lamps and lanterns, easy to match, assembly is convenient;

LED Module with high reliability and high safety;

LED Module use 2835 LED Package, high lighting efficiency, low heat, without Mercury, belong to the environmental protection cold light source;

LED Module electrical parameter design in line with the market mainstream LED power supply, easy to match, the assembly is convenient

LED Module with lower thermal resistance and good heat dissipation;

High CRI , Color temperature more selective.

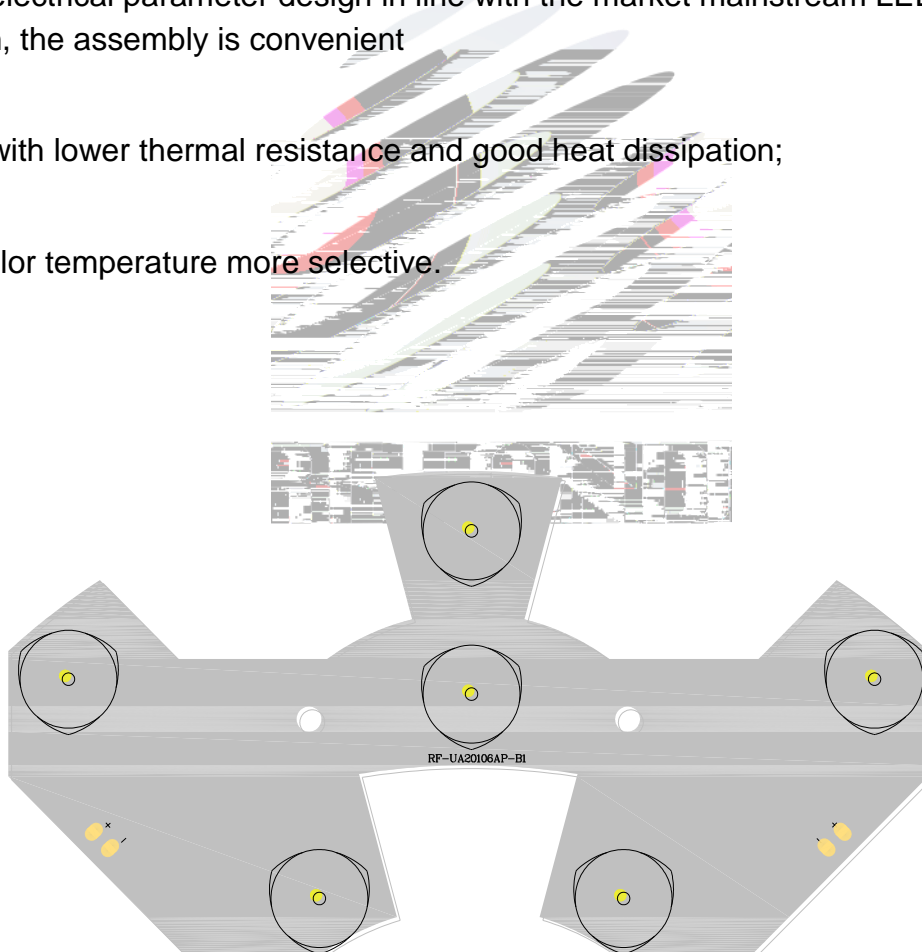

2.LED Module Specification

2.1 Optical-electrical Characteristics(Absolute Maximum Ratings At Ts=25)

Tab.2-1Optical-electrical Characteristics

Refond PN	Module Characteristics						
	Current mA	Voltage(V)		Power(W)		Module LM	
	Typ	Min	Max	Min	Max	Min	Max
RF-MTU302T06-D1 2870-3220K	300	16	21	4.8	6.3	570	660
RF-MTU402T06-D1 3700-4275K)	300	16	21	4.8	6.3	630	720
RF-MTU652T06-D1 5925-7150K)	300	16	21	4.8	6.3	630	720
(I mA)Test condition		Color Rendering Index			Min	Max	Typ
300		80			80	82	84
					5		

Tab.2-2 Absolute Maximum Ratings at Ts=25°C

Parameter	Symbol	Rating	Units
Forward Current	I _F	280	mA
Peak Forward Current	I _{FP}	300	mA
Reverse Voltage	V _R	5	V
Electrostatic Discharge	E _{SD}	2000	V
Operating Temperature	T _{OPR}	-40 ~ +85	
Storage Temperature	T _{STG}	-40 ~ +100	
unction temperature	T _J	≤110	

2.2 LED Module Schematic And Interface Definition

Fig.2-2ED Moduleconnection

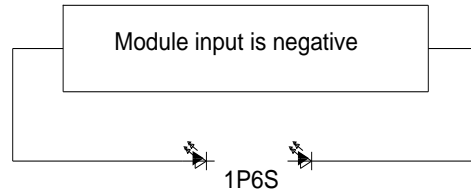

2.3 LED Module rule of naming

RF - MT D 40 2 T 06 - D 1

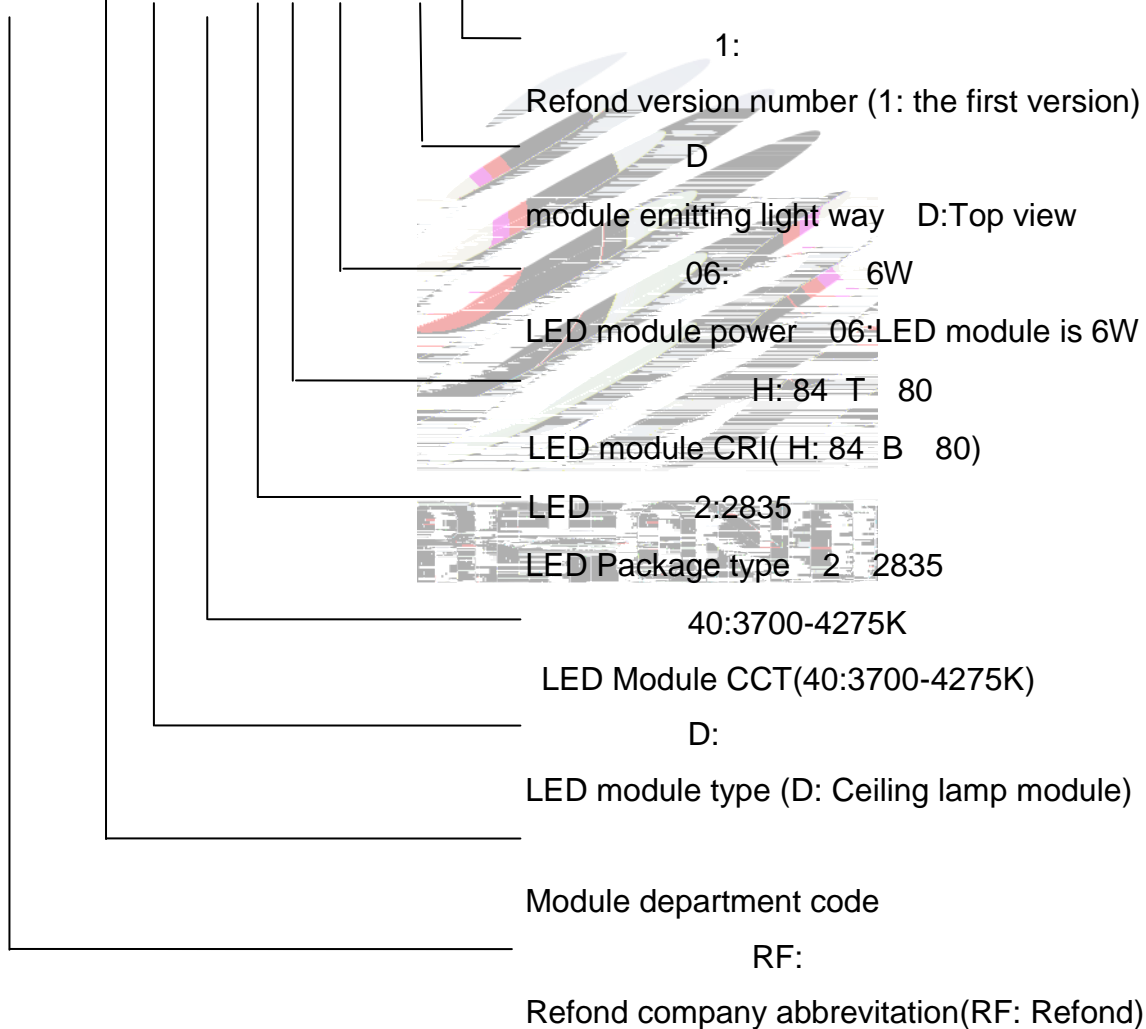

3. Product Specification

3.1 Outline Dimension

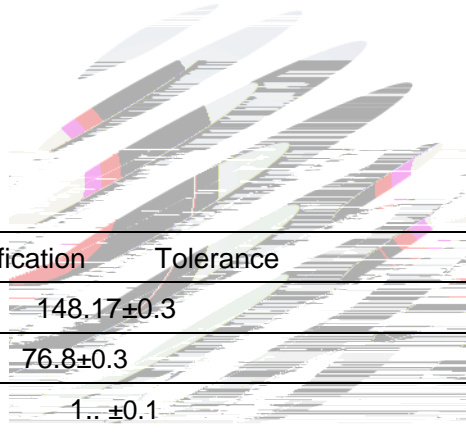
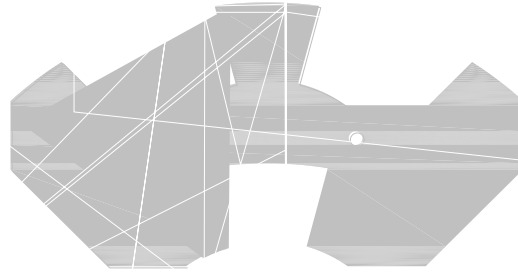

	Dimension	Specification	Tolerance
L	Module Length	148.17±0.3	
W	Module Width	76.8±0.3	
H1	PCB Thickness	PCB 1.1±0.1	



4.LED Module Reliability Test

Tab 4-1 Light Bar Reliability Test

Test Item/	Test Conditions/	Test Time/	Number Of Test/	Judgement Criterions/
Operating Life At Room Temperature/	$T_A=25$ $I_F=300mA$ $T_J<110$	500Hrs	0/6	1. 90-) $V_f<110\%$, $CIE\ x/\ y<0.015$ 2.No catastrophic failure
Operating Life At High Temperature/	$T_A=60$ $I_F=300mA$ $T_J<110$	500Hrs	0/6	
Operating Life At High Temperature And Humidity/	60 $R_H=90\%$ $I_F=300mA$ $T_J<110$	500Hrs	0/6	
Thermal Shock/	-40 15min - P 85 15min	100 cycle	0/6	No DeadLED

Notes

voltage distribution, heat dissipation and others.



5.LED Module Materials Performance Test And Method At Ta=25

Tab 5-1Light Bar Materials Performance Test And Method Ta=25

Test Item	Test Conditions	Test Methods
LED Optical-electrical Characteristics LED	Compliance With Specifications/	Integrating Sphere/
Connector Pull Force/	4	Notes/
LED Push & Pull Force LED	0	
LED Welding Standards LED	Offset Specifications/ X Shift /X - +2 8	
	Y Shift/ Y - +2 8 Angle/ 0 8	

Notes



Fig 5-1Push &Pull Test Equipment

Fig 7-2Push &Pull Test Method

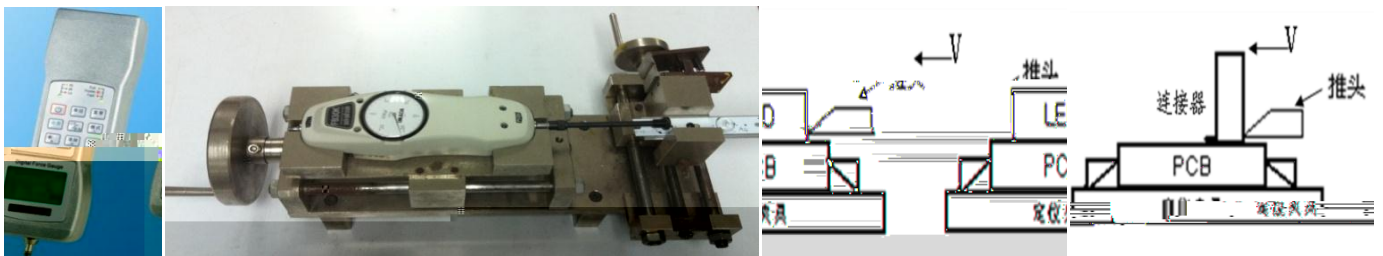

6.Packing Criterion

6.1 Package Diagram /

Fig 8-1 Package Diagram /

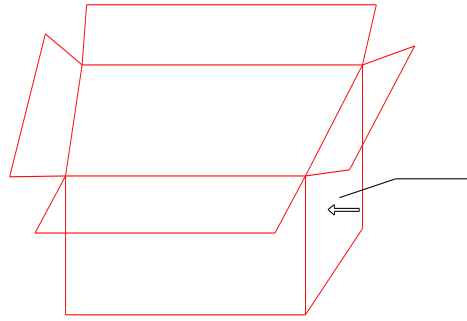

6.2 Carton silk printing/

REFOND LOGO Pay attention to identify

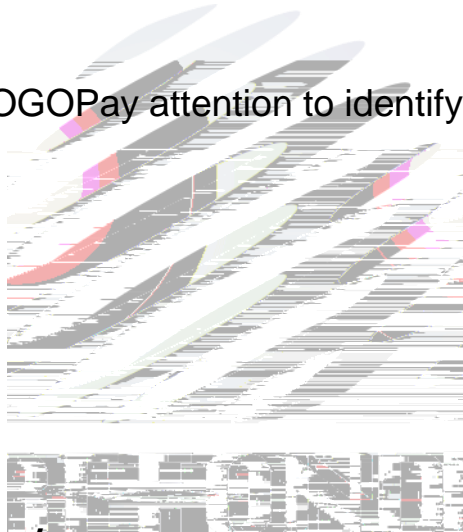

6.3 Label Form Specification/

7. Handling Precautions

(1) LED operating environment and sulfur element composition cannot be over 100PPM in the LED mating usage material. This is provided for informational purposes only and is not a warranty or endorsement. LED

(2) In order to prevent external material from getting into the inside of LED, which may cause the malfunction of LED, the single content of Bromine element is required to be less than 900PPM, the single content of Chlorine element is required to be less than 900PPM, the total content of Bromine element and Chlorine element in the external materials of the application products is required to be less than 1500PPM. This is provided for informational purposes only and is not a warranty or endorsement.

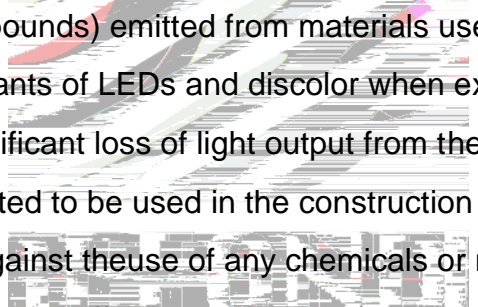

(3) VOCs (Volatile organic compounds) emitted from materials used in the construction of fixtures can penetrate silicone encapsulants of LEDs and discolor when exposed to heat and photonic energy. The result can be a significant loss of light output from the fixture. Knowledge of the properties of the materials selected to be used in the construction of fixtures can help prevent these issues. Refond advises against the use of any chemicals or materials that have been found or are suspected to have an adverse affect on device performance or reliability. To verify compatibility, Refond recommends that all chemicals and materials be tested in the specific application and environment for which they are intended to be used. Attaching LEDs, do not use adhesives that outgas organic vapor.

(4) Handle the component along the side surface by using forceps or appropriate tools; do not directly touch or Handle the silicone lens surface, it may damage the internal circuitry.



(8) Similar to most Solid state devices; LEDs are sensitive to Electro-Static Discharge (ESD) and Electrical Over Stress (EOS).

9>.NO warping or twisting the Light Bar more than 10°. Forbidding holding the LED part or connector part when handling.

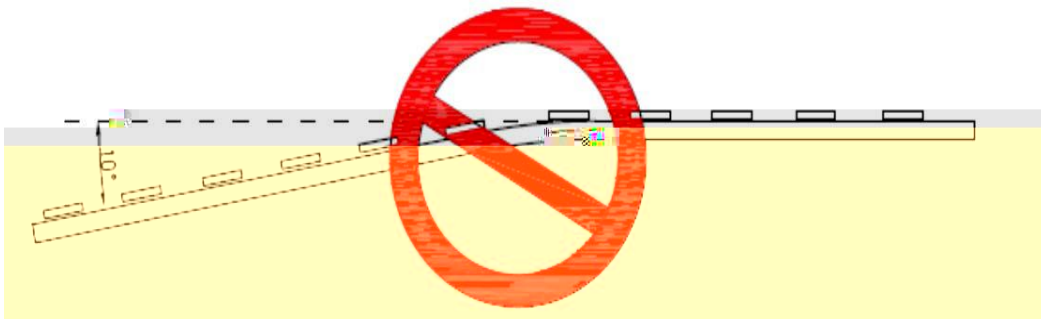

(10) Other points for attention, please refer to our relevant information.





Declare

This specification is written both in English and in Chinese and the latter is formal.