

SPECIFICATION

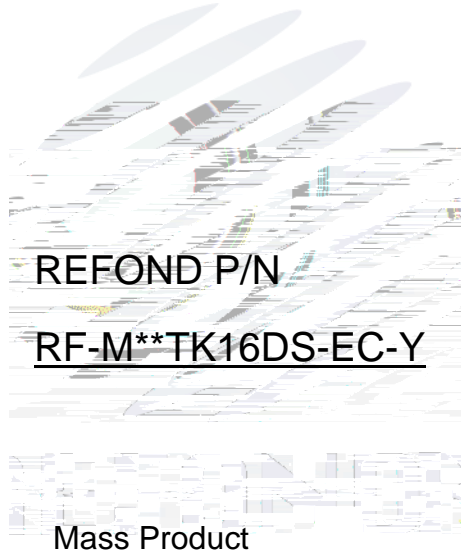

Contents

1. Description	
1.1 General Description	3
1.2 Features	3
1.3 Application	3
1.4 Package Dimension	4
1.5 Product Parameters	5
1.6 Bin Range Of Forward Voltage and Luminous Flux (IF=20mA)	BIN
(IF=20mA)	7
1.7 The Chromaticity Diagram	8
1.8 Typical optical characteristics curves	9
2. Packaging	
2.1 Packaging Specification	13
2.1.2 Reel Dimension	13
2.1.3 Label Form Specification	14
2.2 Moisture Resistant Packing	
2.3 Cardboard Box	
2.4 Reliability Test Items And Conditions	15
2.5 Criteria For Judging Damage	16
3. SMT Reflow Soldering Instructions SMT	
3.1 SMT Reflow Soldering Instructions SMT	
4. Handling Precautions	
4.1 Handling Precautions	



1. Description

1.1

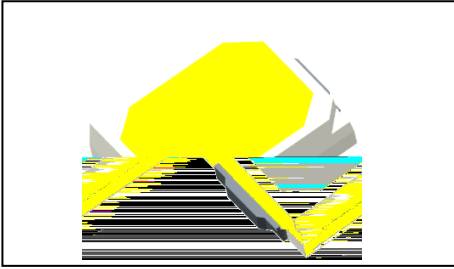

The White LED which was fabricated using a blue chip and the phosphor.

Dimension :2.20mmX1.65mmX0.65mm.

2.20mmX1.65mmX0.65mm

1.2 Features

PLCC2 Package.

Extremely wide viewing angle.

Suitable for all SMT assembly and solder process.

Available on tape and reel.

Moisture sensitivity level: Level 3.

RoHS compliant.

1.3 Application

Hotels,markets,offices,household and other indoor uses.

Optical indicator.

Indoor display.

Decorative lighting.

General use.



1.4 Package Dimension

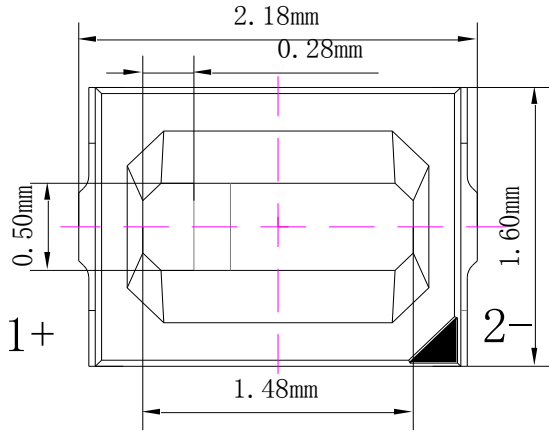

Fig.1-1 Top view

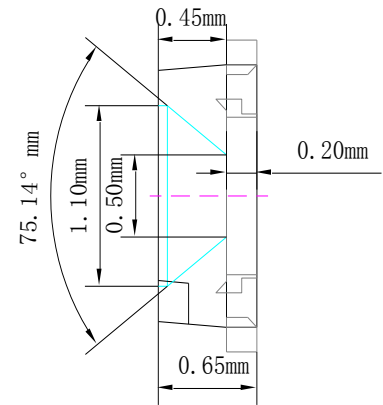

Fig.1-2 Side view

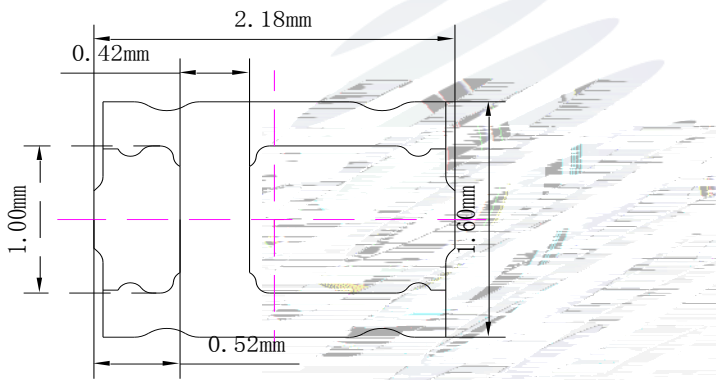

Fig.1-3 Bottom view

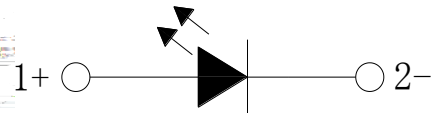
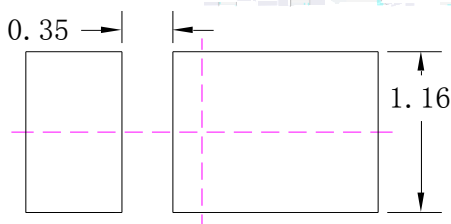

Fig.1-4 Polarity



1.16

Fig.1-5 Soldering patterns

Notes

All dimensions units are millimeters.

All dimensions tolerances are $\pm 0.2\text{mm}$ unless otherwise noted.



1.5 Product Parameters

Table 1-1 Electrical / Optical Characteristics at Ts=25°C

Item	Symbol	Test Condition	Value			Unit
			Min.	Typ	Max.	
Forward Voltage	V_F	$I_F=20mA$	2.7	---	3.1	V
Reverse Current	I_R	$V_R=5V$	---	---	10	μA
Luminous Flux	ν	$I_F=20mA$	5	---	10	lm
Viewing Angle	2 1/2	$I_F=20mA$	---	120	---	deg
Thermal Resistance.	R_{THJ-S}	$I_F=20mA$	---	70	---	/W
Color Rending Index	R_a	$I_F=20mA$	90	---	---	---

Table 1-2 Absolute Maximum Ratings at Ts=25°C

Parameter	Symbol	Rating	Units
Power Dissipation	P_D	132	mW
Forward Current	I_F	40	mA
Peak Forward Current	I_{FP}	100	mA
Reverse Voltage	V_R	5	V
Electrostatic Discharge (HBM)	E_{SD}	2000	V
Operating Temperature	T_{OPR}	-40 ~ +85	
Storage Temperature	T_{OPR}	-40 ~ +85	
Junction Temperature	T_J	91	

Notes

1. 1/10 Duty cycle, 0.1ms pulse width.
2. The above forward voltage measurement allowance tolerance is $\pm 0.1V$.
3. The below color coordinates measurement allowance tolerance is ± 0.003 .
4. The above luminous intensity measurement allowance tolerance $\pm 10\%$.
5. The above Color Rendering Index measurement allowance tolerance is ± 1 ± 1
6. Care is to be taken that power dissipation does not exceed the absolute maximum rating of the product.
7. All measurements were made under the standardized environment of Refond.
8. When the LEDs are in operation the maximum current should be decided after measuring the package temperature, junction temperature should not exceed the maximum rate

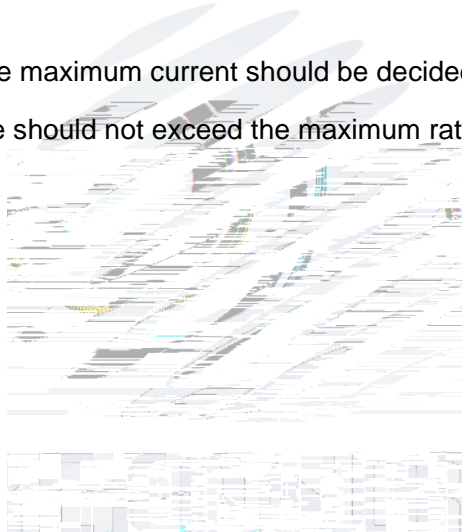

1.6 Bin Range Of Forward Voltage and Luminous Flux (IF=20mA)

BIN (IF=20mA)

Table 1-3

Average VF(V)	F2	G1	G2	H1
	2.7-2.8	2.8-2.9	2.9-3.0	3.0-3.1
product name			BIN CODE	
RF-M27TK16DS-EC-Y (2650-2868K)	A23 5-7	A34 7-9	E27-1 ; E27-2	
RF-M30TK16DS-EC-Y (2830-3028K)	A23 5-7	A34 7-9		
RF-M40TK16DS-EC-Y (3900-4258K)	A03 6-8	A04 8-10	E40-1 ; E40-2	
RF-M60TK16DS-EC-Y (5850-6750K)	A03 6-8	A04 8-10		

BIN	X1	Y1	X2	Y2	X3	Y3	X4	Y4
E27-1	0.4532	0.4202	0.4719	0.4246	0.4644	0.4118	0.4468	0.4077
E27-2	0.4468	0.4077	0.4644	0.4118	0.4570	0.3990	0.4404	0.3952
E30-1	0.4406	0.4160	0.4565	0.4213	0.4497	0.4084	0.4347	0.4034
E30-2	0.4347	0.4034	0.4497	0.4084	0.4428	0.3954	0.4287	0.3908
E40-1	0.3728	0.3837	0.3891	0.3940	0.3852			

1.7 The Chromaticity Diagram

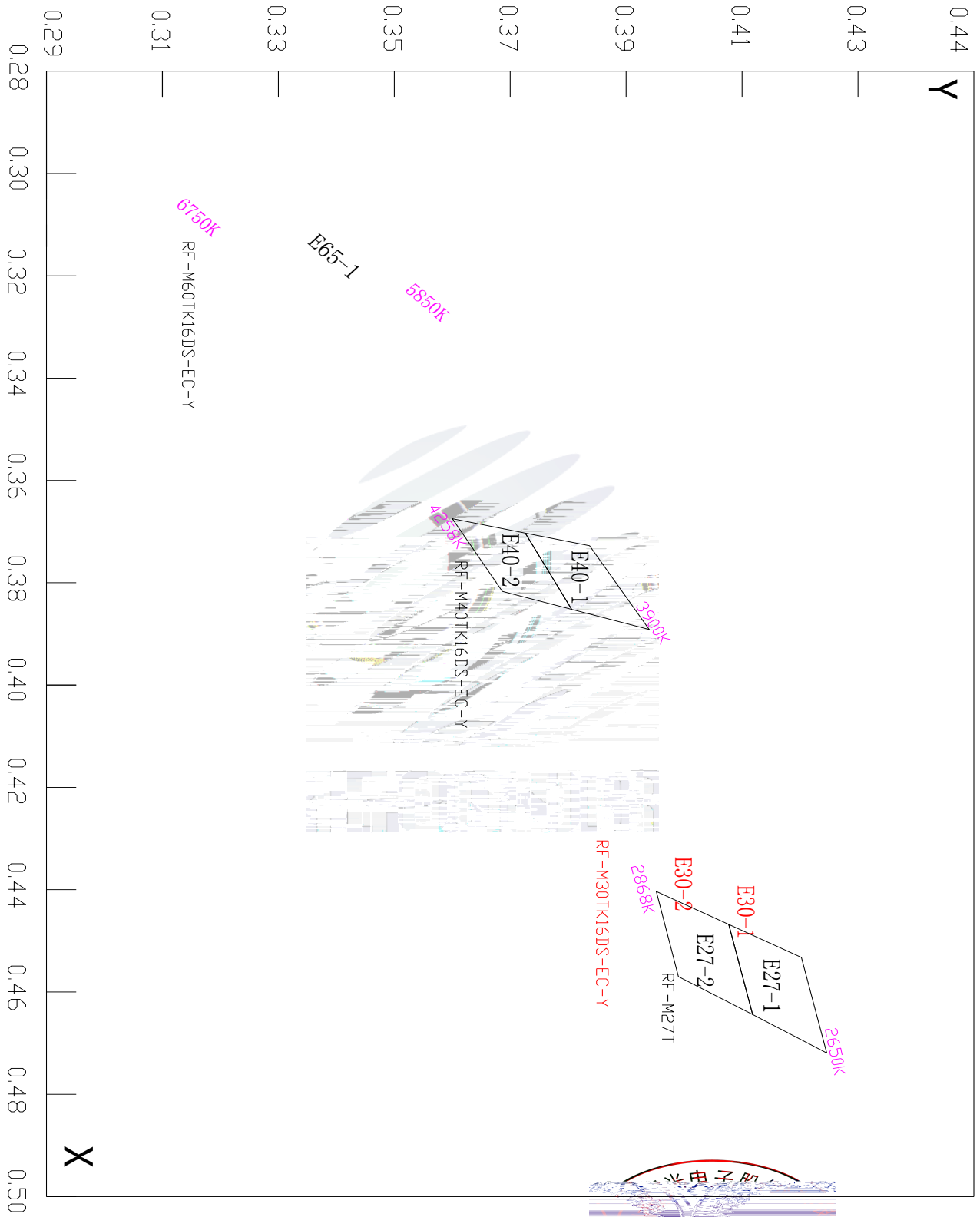

Fig 1-6-1 The C.I.E Chromaticity Diagram CIE

1.8 Typical optical characteristics curves

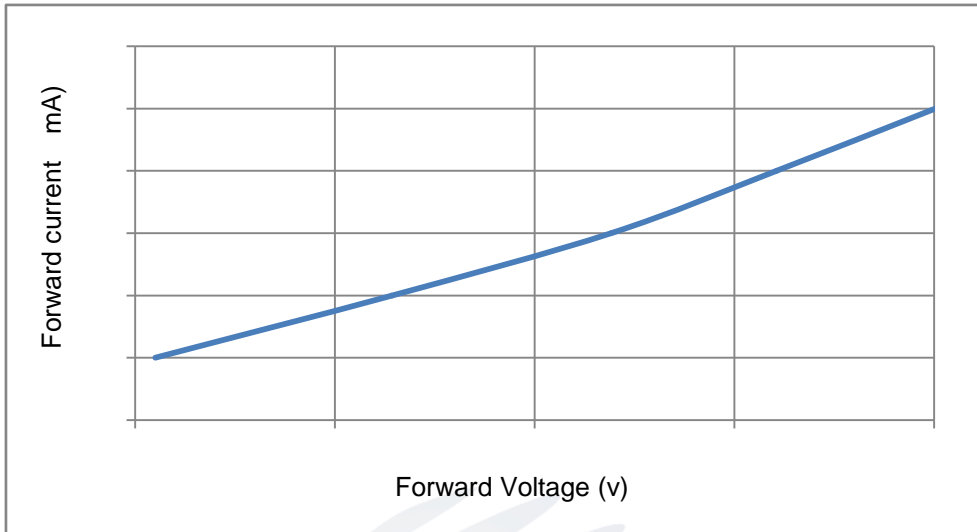

Fig 1-7 Forward Voltage Vs. Forward Current

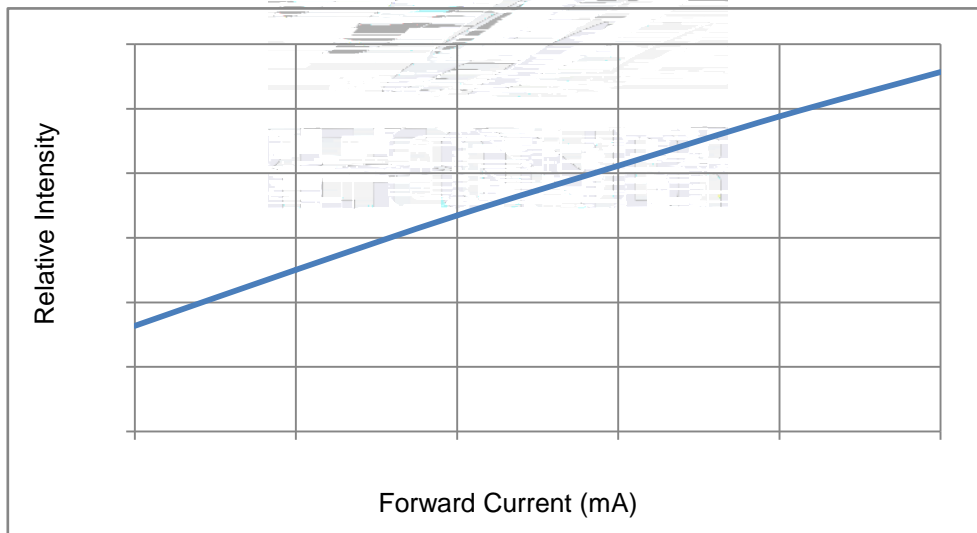

Fig 1-8 Forward Current Vs. Relative Intensity



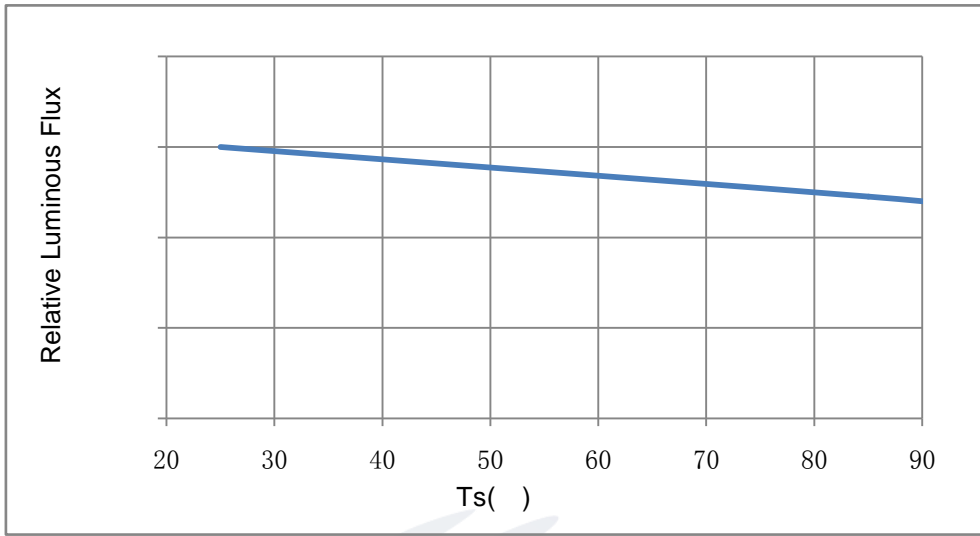

Fig 1-9 Solder Temperature Vs Relative Intensity

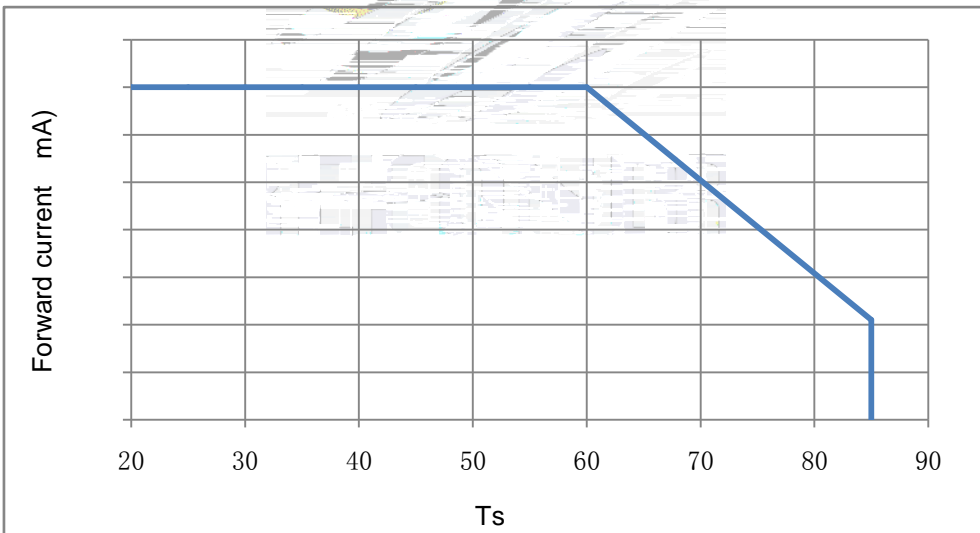
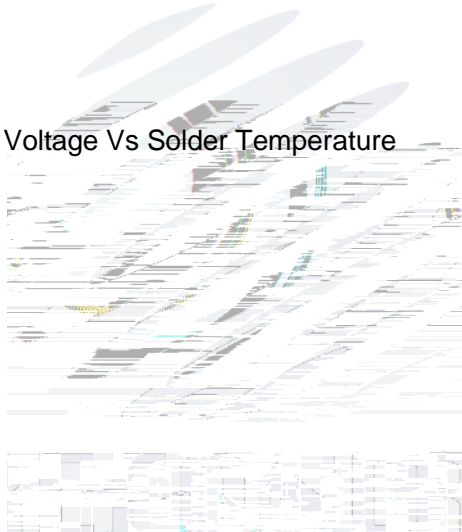

Fig 1-10 Solder Temperature Vs Forward Current



Fig 1-11 Forward Voltage Vs Solder Temperature



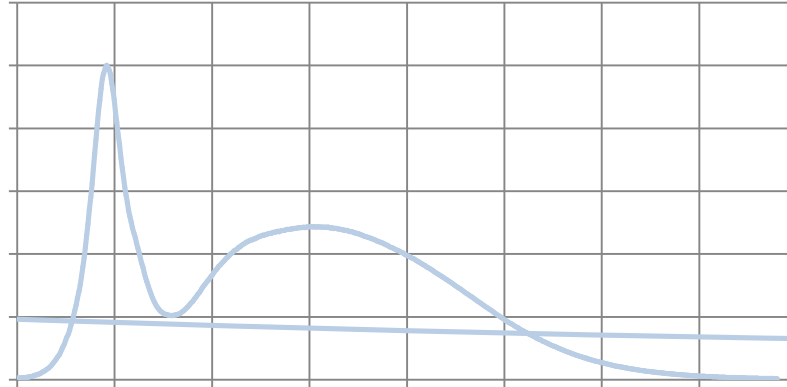
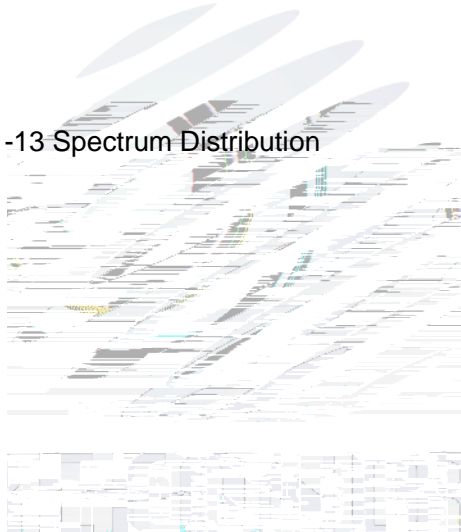

Fig 1-13 Spectrum Distribution



2. Packaging

2.1 Packaging Specification

Package:MAX:4000pcs/reel.

2.1.1 Carrier Tape Dimension

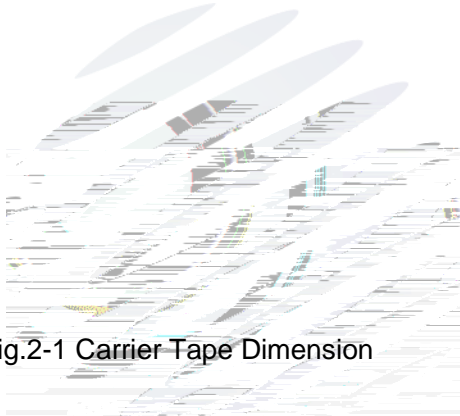

Fig.2-1 Carrier Tape Dimension

2.1.2 Reel Dimension



A 12 0.1mm



Fig.2-2 Reel

Notes

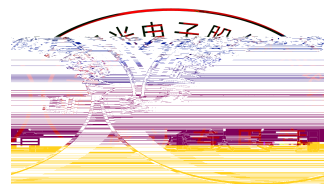
The tolerances unless mentioned $\pm 0.1\text{mm}$. Unit : mm



2.1.3 Label Form Specification

PART NO.	
SPEC NO.	
LOT NO.	
<hr/>	
BIN CODE	XY
v	
V_F	QTY:
	DATE:

Label Parameter

PART NO.	Part Number
SPEC NO.	Spec Number
LOT NO.	Lot Number
BIN CODE	Bin Code
v	Luminous Flux
XY	Chromaticity Bin
V _F	Forward Voltage
QTY	Packing Quantity
DATE	Made Date

Fig 2-3 Label Form

2.2 Moisture Resistant Packing

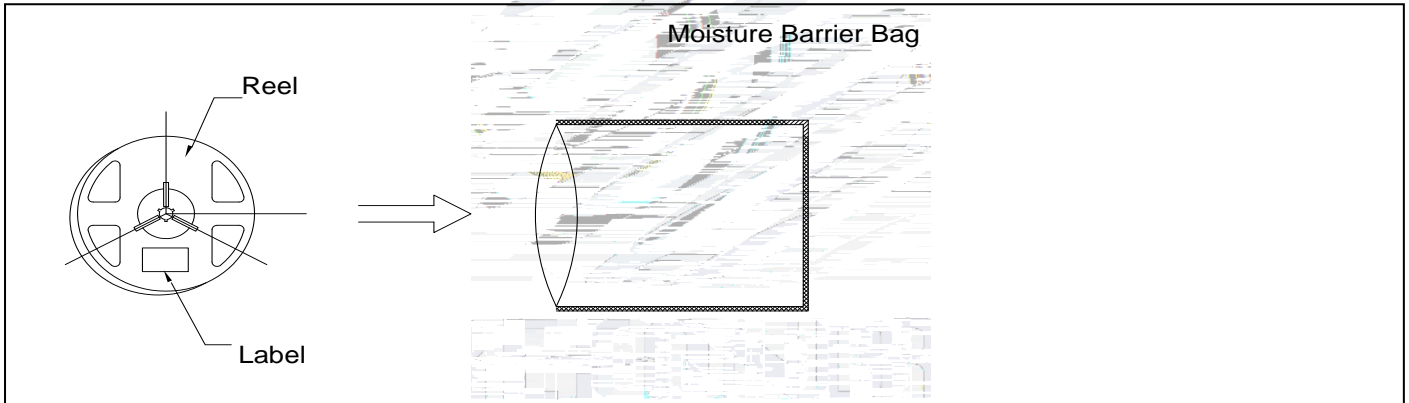

Fig.2-4 Packing specification

2.3 Cardboard Box

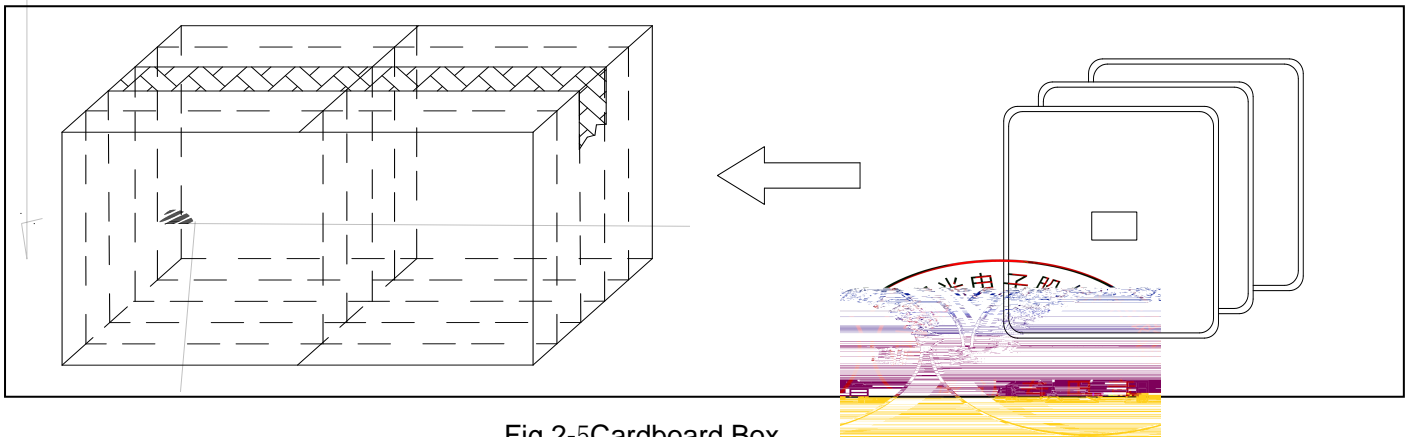

Fig.2-5 Cardboard Box



2.5 Criteria For Judging Damage

Table 2-4 Criteria for judging damage

Test Items	Symbol	Test Condition	Criteria For Judgement	Applicable project
Forward Voltage	V_F			Reflow Thermal Shock
Luminous Flux	v		Maintenance 90%	High and Low Temperature Storage Life Test
Lamp Bead Light Test			No open circuit short circuit or flicke	High Temperature High Humidity Life Test

Notes

1.The above reliability tests is based on the verification of a single/strip LED of Refond's existing experimental platform,the reliability experiment was taken under good heat dissipation conditions. when customers applies the LED to the series and parallel circuit, should take consideration of all the factors such as the current, voltage distribution, heat dissipation and others.

2.The technical information shown in the data sheets is limited to the typical characteristics and circuit examples of the referenced products. It does not constitute the warranting of industrial property nor the granting of any license.



3. SMT Reflow Soldering Instructions SMT

3.1 SMT Reflow Soldering Instructions SMT

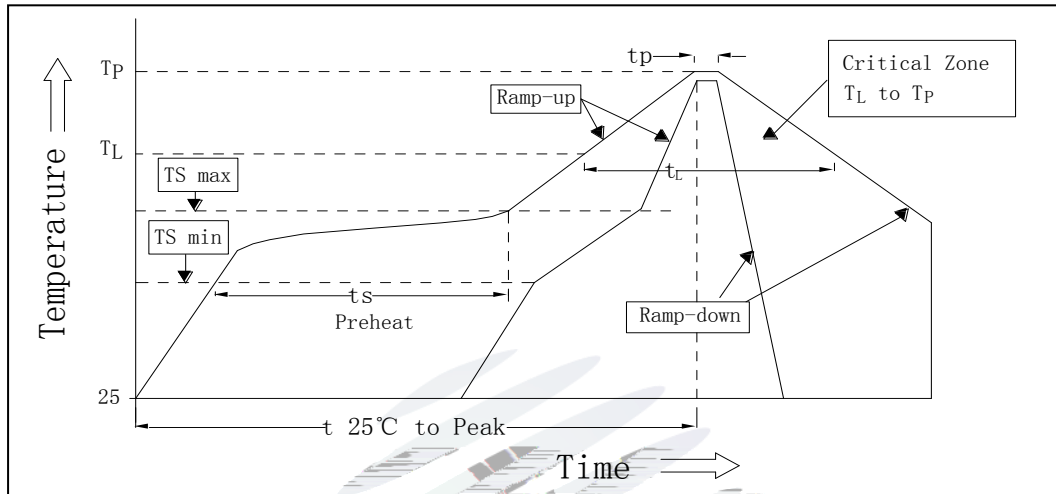

Fig.3-1 SMT Reflow Soldering Instructions SMT

Table 3-1 SMT Reflow Soldering Parameter SMT

Average temperature rise speed	T_{smax} T_P	Max 3 °C/ s 3 °C/
Preheating: minimum temperature	(T_{smin})	150 °C
Preheating: Max temperature	(T_{smax})	200 °C
Preheating: Time	T_{smin} T_{smax}	60 - 120 60s-120s
Time limited to maintain high temperature: the temperature	(T_L)	217 °C
Time limited to maintain high temperature: The Time	(t_L)	Max 60s 60
Peak /Classification of temperature:	(T_P)	260 °C
Time limit classification of peak temperature time	t_p	Max 10s 10
Hold time within 5 °C with the actual peak temperature (T_P) 5 °C	(T_P)	Max 30s 30
Cooling speed		Max 6 °C/ s 6 °C/
Needed time from 25 °C to T_p 25 °C		Max 8 minutes 8



(3) Do not apply mechanical force or excess vibration during the cooling process to normal temperature after soldering. Do not rapidly cool device after soldering.

4. Handling Precautions

4.1 Handling Precautions

(1) LED operating environment and sulfur element composition can not be over 100PPM in the LED mating usage material. This is provided for informational purposes only and is not a warranty or endorsement. LED

(2) In order to prevent external material from getting into the inside of LED, which may cause the malfunction of LED, the single content of Bromine element is required to be less than 900PPM, the single content of Chlorine element is required to be less than 900PPM, the total content of Bromine element and Chlorine element in the external materials of the application products is required to be less than 1500PPM. This is provided for informational purposes only and is not a warranty or endorsement.

(3) VOCs (Volatile organic compounds) emitted from materials used in the construction of fixtures can penetrate silicone encapsulants of LEDs and discolor when exposed to heat and photonic energy. The result can be a significant loss of light output from the fixture. Knowledge of the properties of the materials selected to be used in the construction of fixtures can help prevent these issues. Refond advises against the use of any chemicals or materials that have been found or are suspected to have an adverse effect on device performance or reliability. To verify compatibility, Refond recommends that all chemicals and materials be tested in the specific application and environment for which they are intended to be used. Attaching LEDs, do not use adhesives that outgas organic vapor.



(4) Handle the component along the side surface by using forceps or appropriate tools; Do not directly touch or Handle the silicone lens surface, it may damage the internal circuitry.

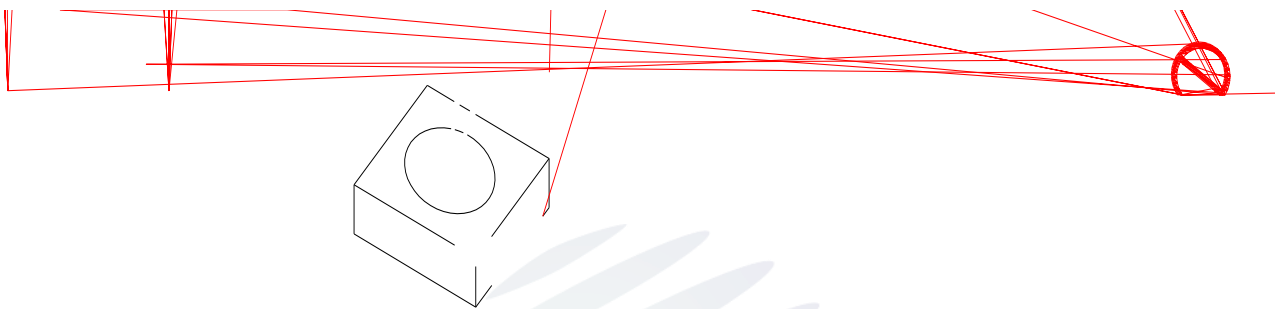

Fig 4-1 Misoperation

(5) In designing a circuit, the current through each LED can not exceed the absolute maximum rating specified for each LED. In the meanwhile, resistors for protection should be applied, otherwise slight voltage shift will cause big current change, burn out may happen. The driving circuit must be designed to allow forward voltage only when it is ON or OFF. If the reverse voltage is applied to LED, migration can be generated resulting in LED damage.

(6) Thermal Design is paramount importance because heat generation may result in the Characteristics decline, such as brightness decreased, Color change and so on. Please consider the heat generation of the LEDs when making the system design. LED

(7) Compared to standard encapsulants, silicone is generally softer, and the surface is more likely to attract dust, requiring special care during processing. In cases where a minimal level of dirt and dust particles cannot be guaranteed, a suitable cleaning solution must be applied to the surface

after the soldering of components. Refond suggests using isopropyl alcohol for cleaning. In case other solvents are used, it must be assured that these solvents do not dissolve the package or resin. Ultrasonic cleaning is not recommended. Ultrasonic cleaning may cause damage to the LED.

Table 4-1 Storage

Conditions		Temperature	Humidity	Time
Storage	Before Opening Aluminum Bag	30	75%	Within 6 Months From Date 6
	After Opening Aluminum Bag	30	60%	24hours 24
Baking		60 ± 5	-	24hours 24

(8) If the moisture absorbent material (silica gel) has faded away or the LEDs have exceeded the storage time, baking treatment should be performed after unpacking and based on the following condition (60±5) °C for above 24 hours.

If the package is flatulence or damaged, please notify the sales staff to assist.

(9) Similar to most Solid state devices; LEDs are sensitive to Electro-Static Discharge (ESD) and Electrical Over Stress (EOS).





Declare

This specification is written both in English and in Chinese and the latter is formal.

