

SPECIFICATION

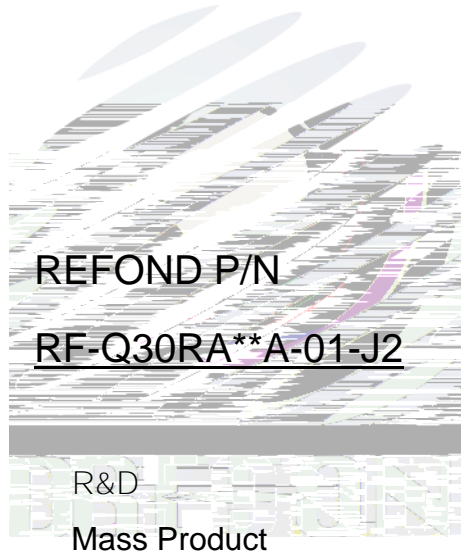

Contents

1. Description	3
1.1 General Description	3
1.2 Features	3
1.3 Application	3
1.4 Package Dimension	4
1.31/Lang (en-US) > BDC BT1 0 0 15 EMC /Span A MCID 33/Lang (en-US) > BDC BT/F3 12 Tf1 0 0 1 36 567	





1.4 Package Dimension

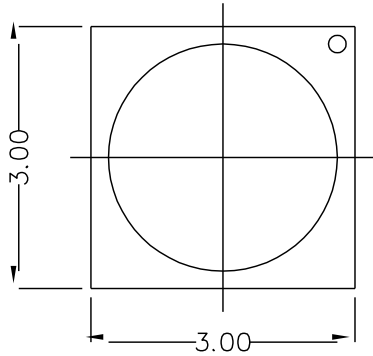

Fig.1-1 Top view

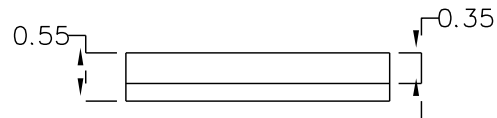

Fig.1-2 Side view

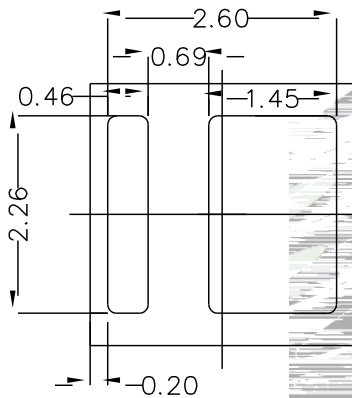

Fig.1-3 Bottom view

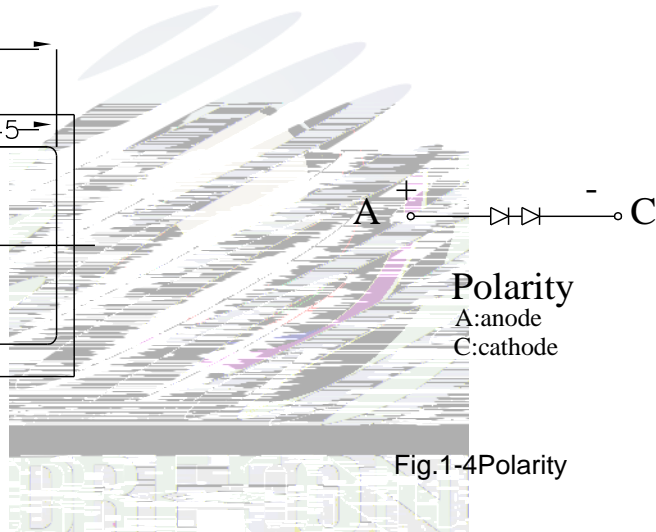

Fig.1-4 Polarity

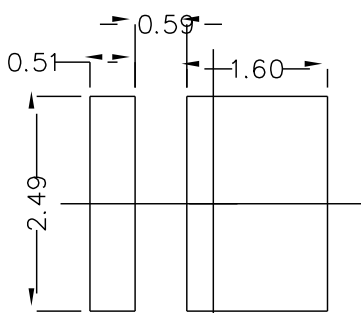

Fig.1-5 Soldering patterns

Notes

1. All dimensions units are millimeters.
2. All dimensions tolerances are $\pm 0.2\text{mm}$ unless otherwise noted.

0.05

1.5 Product Parameters

Table 1-1 Electrical / Optical Characteristics at Ts=25°C

Product		Symbol	test condition	Value			unit
				Min.	Max.	Typ.	
Forward Voltage	Rank R2	Vf	If =150mA	6.0	6.2	---	V
	Rank S1			6.2	6.4	---	V
	Rank S2			6.4	6.6	---	V
RF-Q30RA27A-01-J2 (2575-2865K)	Rank FC4		If =150mA	120	130	130.0	lm
	Rank FC5			130	140		lm
RF-Q30RA30A-01-J2 (2865-3215K)	Rank FC5		If =150mA	130	140	138.0	lm
	Rank FC6			140	150		lm
RF-Q30RA40A-01-J2 (3660-4195K)	Rank FC6		If =150mA	140	150	145.0	lm
	Rank FC7			150	160		lm
RF-Q30RA50A-01-J2 (4600-5100K)	Rank FC6		If =150mA	140	150	145.0	lm
	Rank FC7			150	160		lm
RF-Q30RA57A-01-J2 (5100-5790K)	Rank FC6		If =150mA	140	150	145.0	lm
	Rank FC7			150	160		lm
RF-Q30RA65A-01-J2 (5790-6575K)	Rank FC6		If =150mA	140	150	145.0	lm
	Rank FC7			150	160		lm
Reverse Current		Vr=10V	IR	---	10	---	uA
Viewing Angle			If =150mA	---	---	110	Deg
Color Rendering Index		Ra	If =150mA	70	---	72	---
Thermal resistance		R _{THJ-S}	If =150mA	---	---	18	/W

Table 1-2 Absolute Maximum Ratings at Ts=25°C

Parameter	Symbol	Rating	Units
Power Dissipation	P_D	1200	mW
Forward Current	I_F	180	mA
Peak Forward Current	I_{FP}	240	mA
Reverse Voltage	V_R	10	V
Electrostatic Discharge(HBM)	E_{SD}	2000	V
Operating Temperature	T_{OPR}	-40 ~ +100	
Storage Temperature	T_{OPR}	-40 ~ +100	
Junction Temperature	T_J	125	

Notes

- 1/10 Duty cycle, 0.1ms pulse width. 0.1ms, 1/10.
- The above forward voltage measurement allowance tolerance is $\pm 0.1V$.
- The above color coordinates measurement allowance tolerance is ± 0.003 ± 0.003 .
- The above luminous intensity measurement allowance tolerance $\pm 10\%$.
- Care is to be taken that power dissipation does not exceed the absolute maximum rating of the product.
- All measurements were made under the standardized environment of Refond.
- When the LEDs are in operation the maximum current should be decided after measuring the package temperature, junction temperature should not exceed the maximum rate. LED

1.6 The C.I.E Chromaticity Diagram CIE

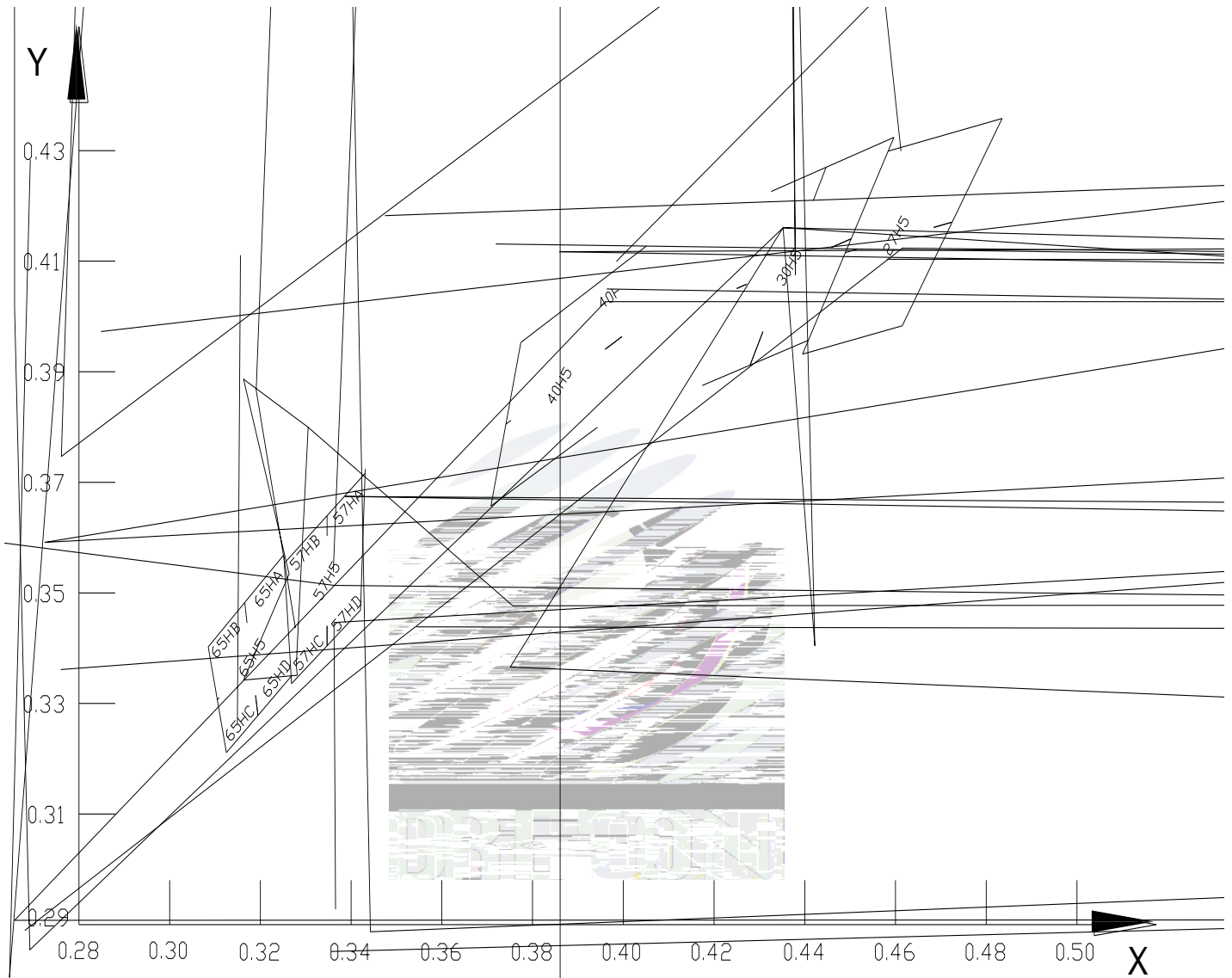

Fig 1-6 The C.I.E Chromaticity Diagram CIE

Bin data

ANSI 5-Step										
Bin Code	X	Y	a	b						
27H5	0.4600	0.4140	0.01350	0.00700	53°42					
30H5	0.4365	0.4091	0.01390	0.00680	53°13					
40H5	0.3856	0.3876	0.01565	0.00670	53°43					
50H5	0.3502	0.3661	0.01370	0.00590	59°37					
57H5	0.3343	0.3518	0.01243	0.00533	59°09					
65H5	0.3180	0.3380	0.01561	0.00665	58°34					
ANSI 7-Step										
Bin Code	X1	Y1	X2	Y2	X3	Y3	X4	Y4	X5	Y5
27HA	0.4835	0.4358	0.4725	0.4171	0.4684	0.4161	0.4666	0.4250	0.4710	0.4329
27HB	0.4710	0.4329	0.4666	0.4250	0.4517	0.4122	0.4488	0.4114	0.4583	0.4298
27HC	0.4517	0.4122	0.4543	0.4026	0.4505	0.3958	0.4359	0.3932	0.4490	0.4116
27HD	0.4684	0.4161	0.4725	0.4171	0.4615	0.3983	0.4505	0.3958	0.4543	0.4026
30HA	0.4597	0.4324	0.4502	0.4140	0.4458	0.4125	0.4419	0.4209	0.4447	0.4210
30HB	0.4447	0.4210	0.4419	0.4209	0.4272	0.4058	0.4250	0.4051	0.4326	0.4226
30HC	0.4250	0.4051	0.4272	0.4058	0.4308	0.3973	0.4279	0.3912	0.4174	0.3875
30HD	0.4458	0.4125	0.4725	0.4171	0.4408	0.3957	0.4279	0.3912	0.4308	0.3973
40HA	0.4051	0.4128	0.3997	0.3963	0.3960	0.3940	0.3902	0.4003	0.3913	0.4040
40HB	0.3913	0.4040	0.3902	0.4003	0.3752	0.3812	0.3741	0.3805	0.3774	0.3953
40HC	0.3741	0.3805	0.3752	0.3812	0.3835	0.3762	0.3826	0.3728	0.3708	0.3657
40HD	0.3960	0.3940	0.3997	0.3963	0.3943	0.3799	0.3826	0.3728	0.3835	0.3762
50HA	0.3606	0.3868	0.3587	0.3726	0.3510	0.3762	0.3512	0.3791	/	/
50HB	0.3512	0.3791	0.3510	0.3762	0.3428	0.3641	0.3431	0.3724	/	/
50HC	0.3424	0.3551	0.3493	0.3532	0.3491	0.3532	0.3421	0.3477	/	/
50HD	0.3586	0.3719	0.3570	0.3595	0.3491	0.3532	0.3493	0.3559	/	/
57HA	0.3431	0.3716	0.3426	0.3592	0.3422	0.3589	0.3347	0.3603	0.3347	0.3640
57HB	0.3347	0.3640	0.3347	0.3603	0.3264	0.3448	0.3261	0.3445	0.3253	0.3554
57HC	0.3261	0.3445	0.3264	0.3448	0.3347	0.3440	0.3347	0.3404	0.3269	0.3336
57HD	0.3422	0.3589	0.3426	0.3592	0.3421	0.3469	0.3347	0.3404	0.3347	0.3440
65HA	0.3252	0.3569	0.3260	0.3459	0.3251	0.3450	0.3171	0.3445	0.3165	0.3482
65HB	0.3165	0.3482	0.3171	0.3445	0.3109	0.3311	0.3105	0.3307	0.3085	0.3402
65HC	0.3105	0.3307	0.3109	0.3311	0.3189	0.3315	0.3195	0.3278	0.3125	0.3211
65HD	0.3251	0.3450	0.3260	0.3459	0.3268	0.3349	0.3195	0.3278	0.3189	0.3315

1.7 Typical optical characteristics curves

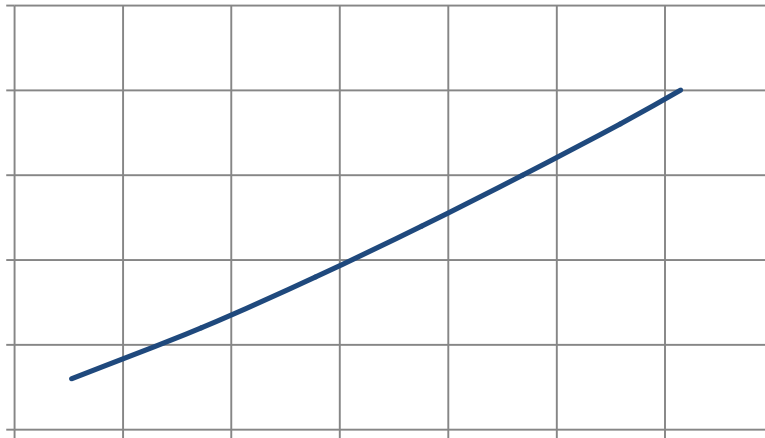

Fig 1-9 Forward Voltage Vs. Forward Current

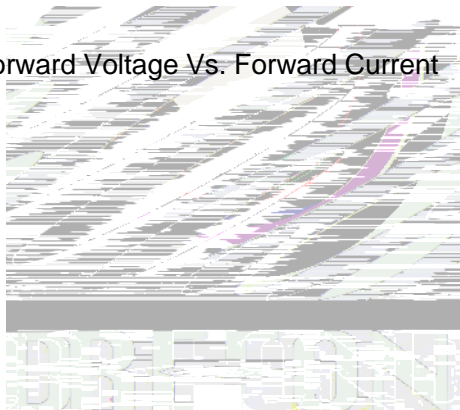
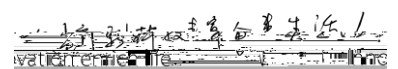

Fig 1-10 Forward Current Vs. Relative Intensity

Å



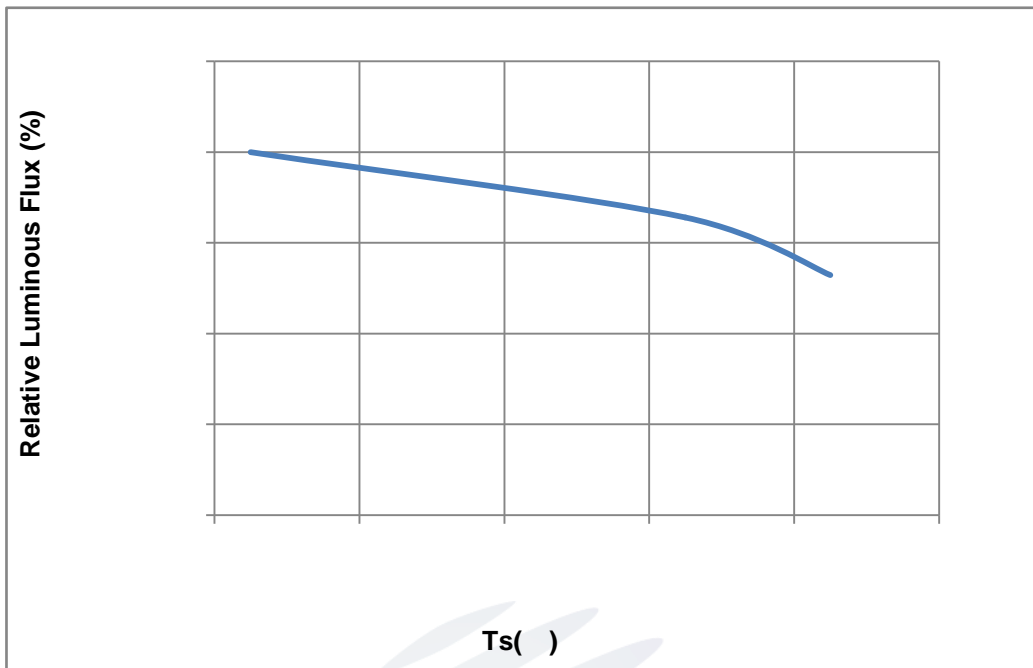

Fig 1-11 Solder Temperature Vs Relative Intensity

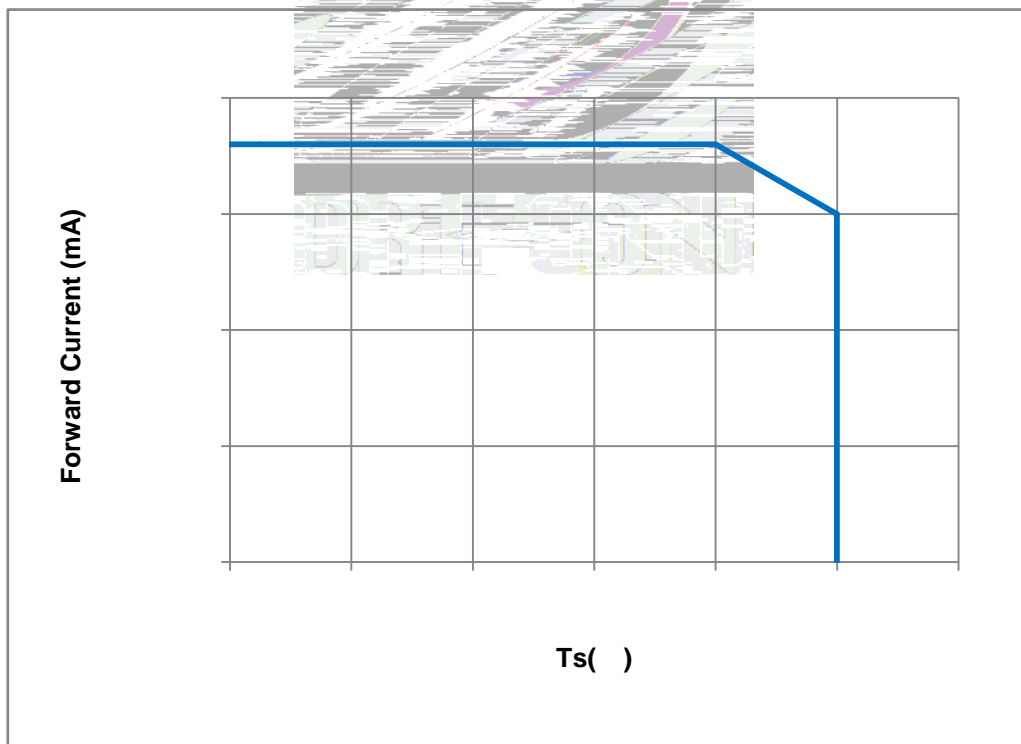

Fig 1-12 Solder Temperature Vs. Forward Current

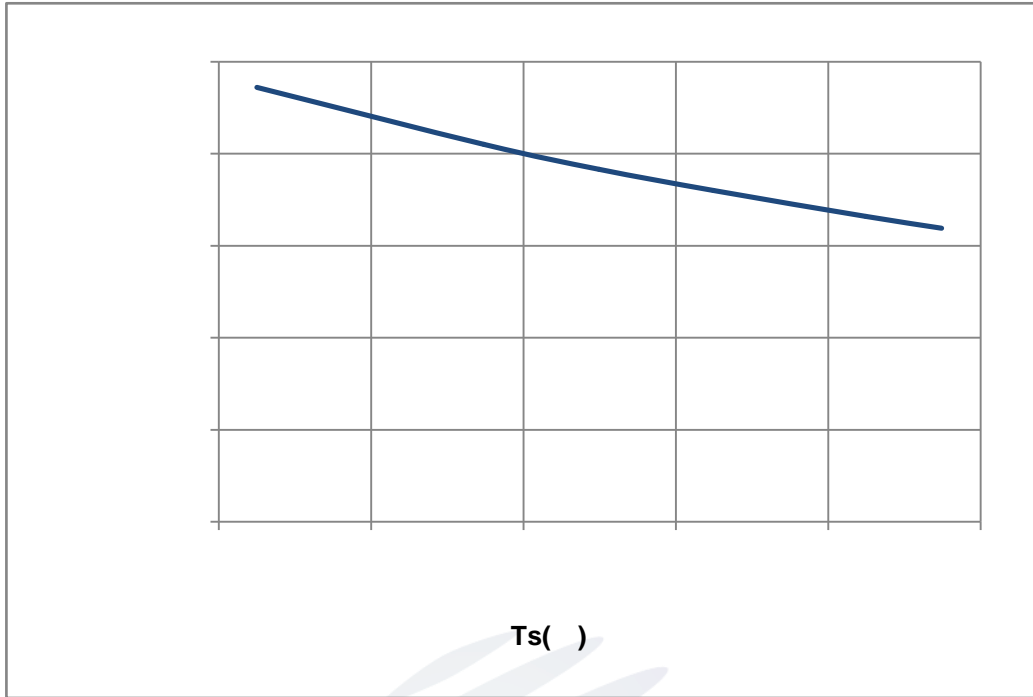

Fig 1-13 Forward Voltage Vs Solder Temperature

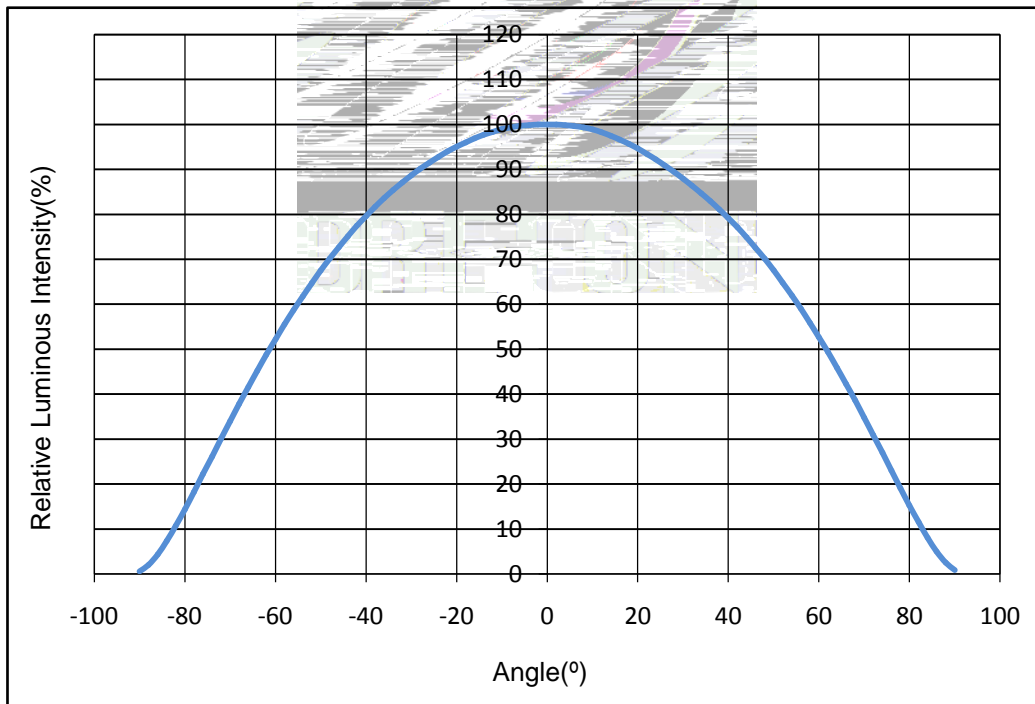

Fig 1-14 Radiation diagram

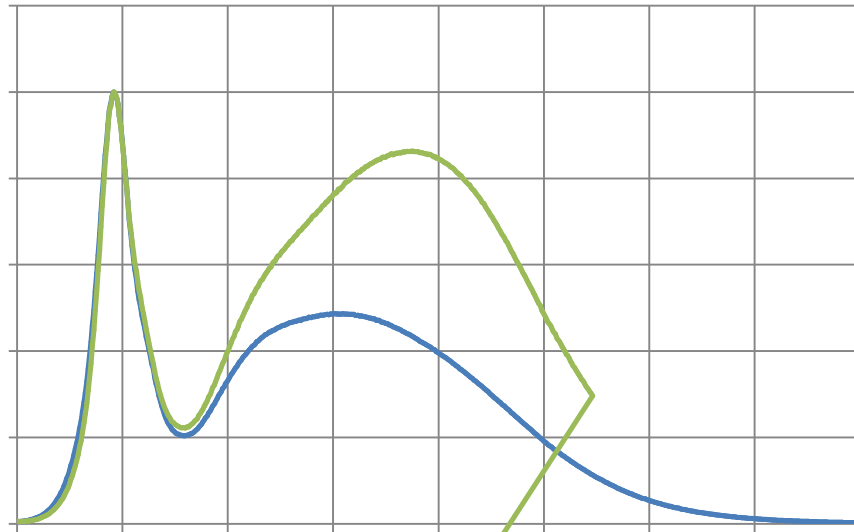
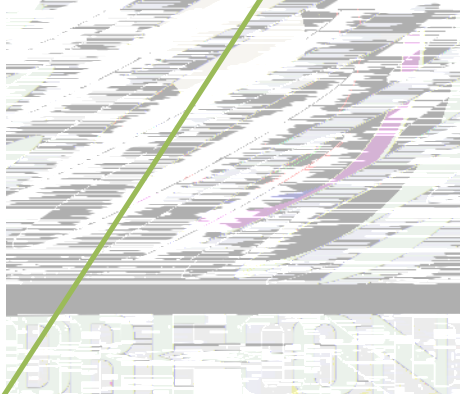
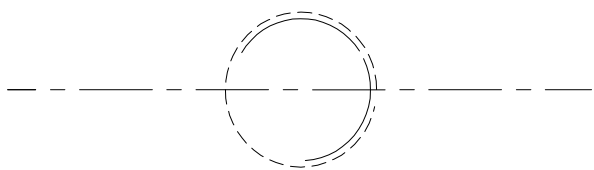

Fig 1-15 Spectrum Distribution





2.1.3 Label Form Specification

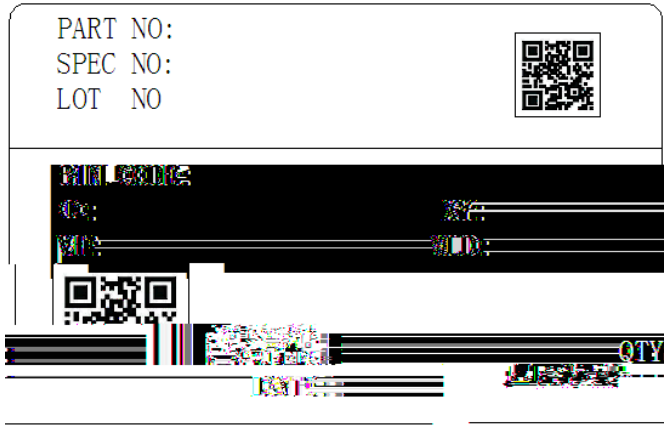

Fig 2-3 Title

Table 2-2 Title

PART NO.	Part Number
SPEC NO.	Spec Number
LOT NO.	Lot Number
BIN CODE	Bin Code
	Luminous flux
XY	Chromaticity Bin
V _F	Forward Voltage
WLD	Wavelength
QTY	Packing Quantity
DATE	Made Date

2.2 Moisture Resistant Packing

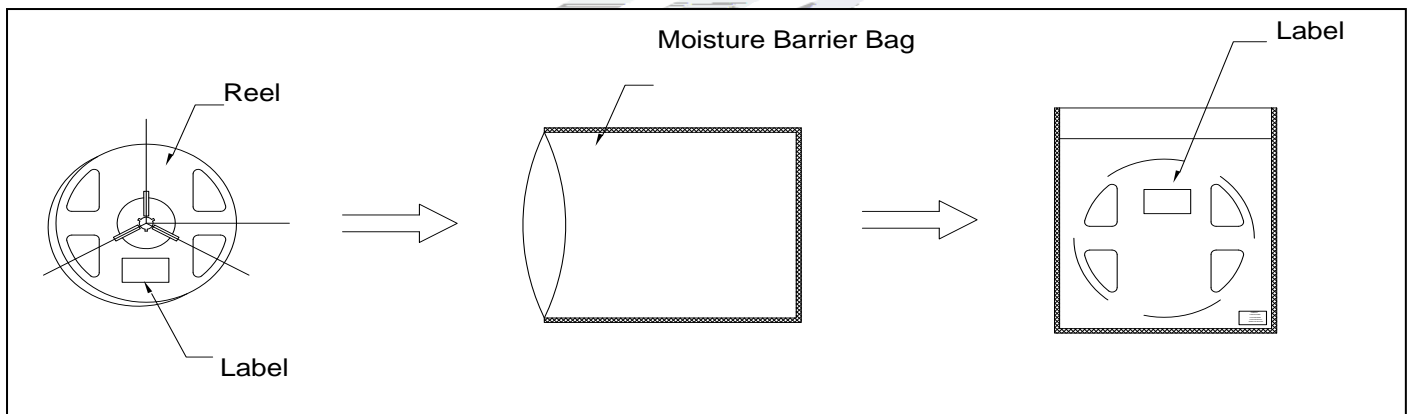

Fig.2-4Title

2.3 Cardboard Box

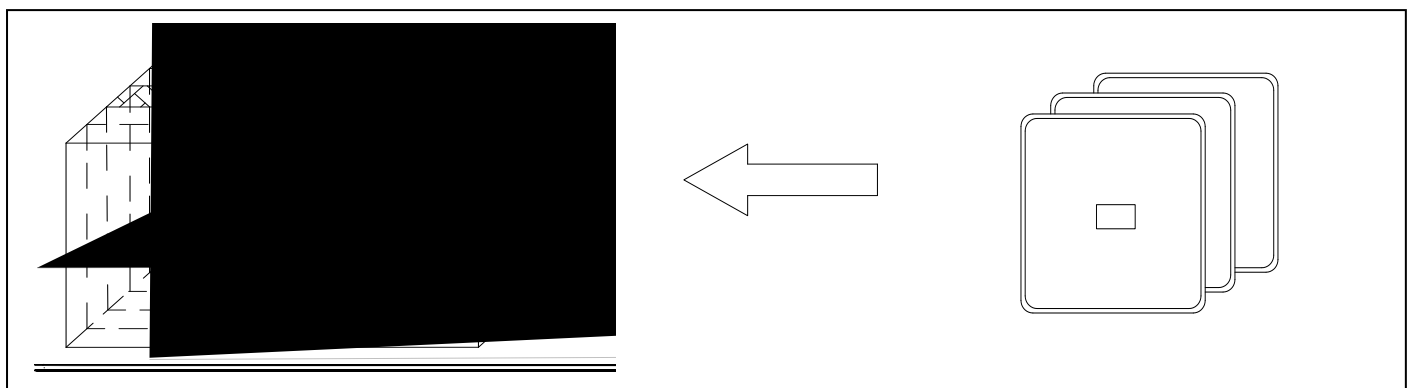

Fig.2-5Title

2.4 Reliability Test Items And Conditions

Table 2-3 Title

Test Items	Ref.Standard	Test Condition	Time	Quantity	Ac/Re /
Reflow	JESD22-B106	Temp:260 max T=10 sec	2times.	10Pcs.	0/1
Temperature Cycle	JESD22-A104	100 30 min. -40 30 min.	300Cycles	10Pcs.	0/1
Thermal Shock	JESD22-A106	-40 15min 10sec 100 15min	300Cycles	10Pcs.	0/1
High Temperature Storage	JESD22-A103	Temp.:105	1000Hrs.	10Pcs.	0/1
Low Temperature Storage	JESD22-A119	Temp.: -40	1000Hrs.	10Pcs.	0/1
Life Test	JESD22-A108	Ta=25 If =150mA	1000Hrs.	10Pcs.	0/1
High Temperature High Humidity Life Test	JESD22-A101	60 / 90%RH If=150mA	1000Hrs.	10Pcs.	0/1

2.5 Criteria For Judging Damage

Table 2-4 Title

Test Items	Symbol	Test Condition	Criteria For Judgement	Applicable project
Forward Voltage	Vf	If =150mA	10%	Reflow Temperature Cycle High and Low Temperature Storage Life Test
Luminous Flux		If =150mA	Maintenance 85%	Temperature Storage Life Test
High Temperature High Humidity Life Test	/	If =150mA	No open circuit, shortcircuit or flicke	High Temperature High Humidity Life Test

Notes

1.The Reliability tests are based on Refond existing test platform.

2.The technical information shown in the data sheets are limited to the typical characteristics and circuit examples of the referenced products. It does not constitute the warranting of industrial property nor the granting of any license. voltage distribution, heat dissipation and others.

LED



3. SMT Reflow Soldering Instructions SMT

3.1 SMT Reflow Soldering Instructions SMT

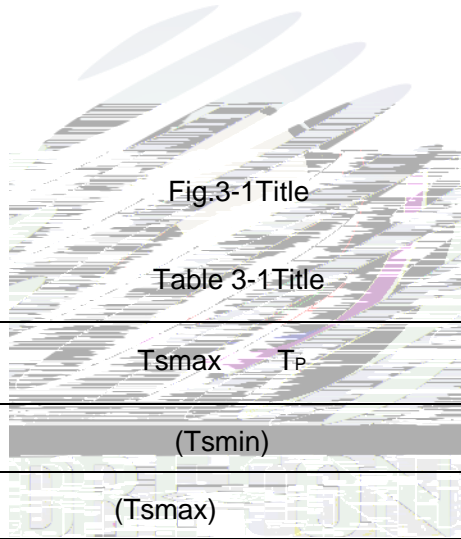

Average temperature rise speed	T_{smax} T_P	3 °C/ Max 3 °C/ s
Preheating: minimum temperature	(T_{smin})	150 °C
Preheating: Max temperature	(T_{smax})	200 °C
Preheating: Time	T_{smin} T_{smax}	60 - 120 60s-120s
Time limited to maintain high temperature: the temperature	(T_L)	217 °C

Notes

(1)Reflow soldering should not be done more than two times. In the case of more than 24 hours passed soldering after first, LEDs will be damaged. 24

LED

(2)When soldering , do not put stress on the LEDs during heating.

3.1.1 Soldering Iron

(1) When hand soldering, keep the temperature of iron below less 300°C less than 3 seconds
300 3

(2) The hand solder should be done only one time.

3.1.2 Repairing

Repair should not be done after the LEDs have been soldered. When repairing is unavoidable, a double-head soldering iron should be used (as below figure). It should be confirmed in advance whether the characteristics of LEDs will or will not be damaged by repairing.

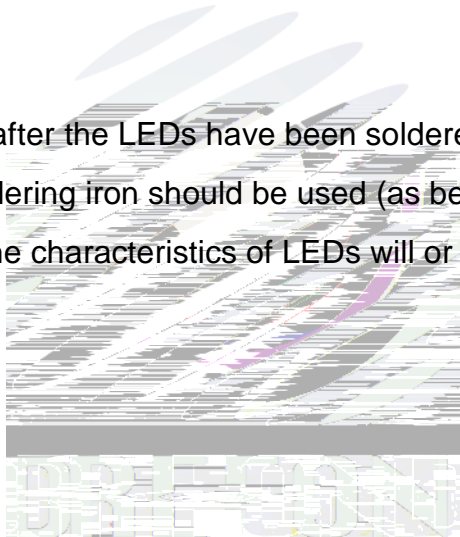

LED

LED

3.1.3 Cautions

(1) The encapsulated material of the LEDs is silicone. Therefore the LEDs have a soft surface on the top of package. The pressure to the top surface will be influence to the reliability of the LEDs. Precautions should be taken to avoid the strong pressure on the encapsulated part. So when use the picking up nozzle, the pressure on the silicone resin should be proper. LED

LED

(2) Components should not be mounted on warped (non coplanar) portion of PCB. After soldering, do not warp the circuit board.LED PCB

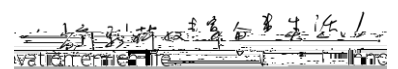

(3) Do not apply mechanical force or excess vibration during the cooling process to normal temperature after soldering. Do not rapidly cool device after soldering.



4. Handling Precautions

4.1 Handling Precautions

(1) LED operating environment and sulfur element composition cannot be over 100PPM in the LED mating usage material. This is provided for informational purposes only and is not a warranty or endorsement. LED LED 100PPM.

(2) In order to prevent external material from getting into the inside of LED, which may cause the malfunction of LED, the single content of Bromine element is required to be less than 900PPM, the single content of Chlorine element is required to be less than 900PPM, the total content of Bromine element and Chlorine element in the external materials of the application products is required to be less than 1500PPM. This is provided for informational purposes only and is not a warranty or endorsement.

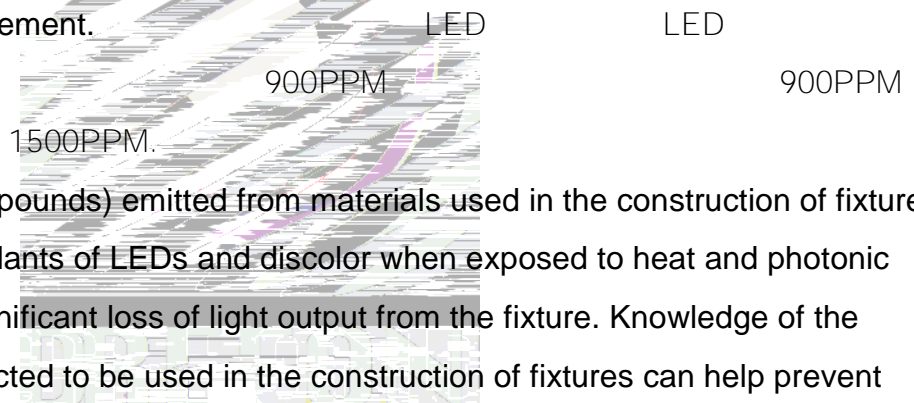

(3) VOCs (Volatile organic compounds) emitted from materials used in the construction of fixtures can penetrate silicone encapsulants of LEDs and discolor when exposed to heat and photonic energy. The result can be a significant loss of light output from the fixture. Knowledge of the properties of the materials selected to be used in the construction of fixtures can help prevent these issues. Refond advises against the use of any chemicals or materials that have been found or are suspected to have an adverse affect on device performance or reliability. To verify compatibility, Refond recommends that all chemicals and materials be tested in the specific application and environment for which they are intended to be used. Attaching LEDs, do not use adhesives that outgas organic vapor. LED

LED

LED

LED

(4) Handle the component along the side surface by using forceps or appropriate tools; do not directly touch or Handle the silicone lens surface, it may damage the internal circuitry.

Fig 4-1 Title

(5) In designing a circuit, the current through each LED can not exceed the absolute maximum rating specified for each LED. In the mean while, resistors for protection should be applied,

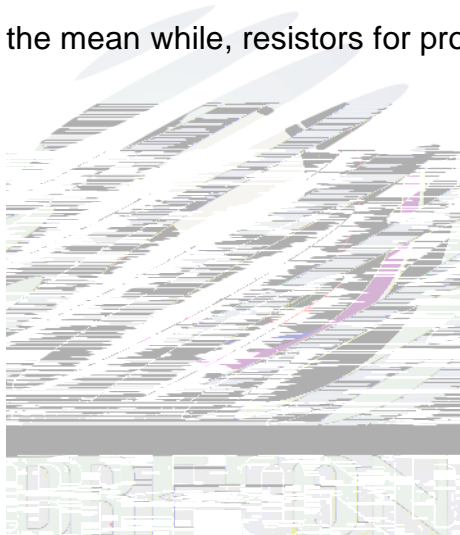

LED

Table 4-1 Storage

Conditions		Temperature	Humidity	Time
Storage	Before Opening Aluminum Bag	30	75%	Within 1 Year From Date
	After Opening Aluminum Bag	30	60%	24hours 24







www.refond.com



Declare

This specification is written both in English and in Chinese and the latter is formal.