

# SPECIFICATION 产品规格书

REFOND P/N 产品型号

RF-P\*\*MI32DS-AF-N-Y

R&D 研发

Mass Product 量产供货

## Contents 目录

1. Description 产品介绍	
1.1 General Description 产品描述	
1.2 Features 产品特征	
1.3 Application 产品应用	
1.4 Package Dimension 封装尺寸	
1.5 Product Parameters 产品参数	
1.6 Bin Range Of Forward Voltage and Luminous Flux (IF=60mA) 电压与流明分 BIN 范围 (IF=60mA)	
1.7 Typical optical characteristics curves 典型光学特性曲线	
2. Packaging 产品包装	
2.1 Packaging Specification 包装规格	
2.1.1 Carrier Tape Dimension 载带尺寸 .....	12
2.1.2 Reel Dimension 卷盘尺寸 .....	12
2.1.3 Label Form Specification 标签规格 .....	13
2.2 Moisture Resistant Packing 防潮包装	
2.3 Cardboard Box 包装纸箱	
2.4 Reliability Test Items And Conditions 信赖性测试项目及条件	
2.5 Criteria For Judging Damage 失效判定标准	
3. SMT Reflow Soldering Instructions SMT 回流焊说明	
3.1 SMT Reflow Soldering Instructions SMT 回流焊说明	
4. Handling Precautions 产品使用注意事项	
4.1 Handling Precautions 产品使用注意事项	

## 1. Description 产品介绍

### 1.1 General Description 产品描述

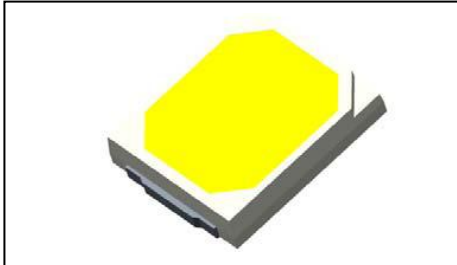

The White LED which was fabricated using a blue chip and the phosphor

Product Package: 2.75mmX3.5 7mm.

该产品为白光 LED，是由蓝光芯片激发荧光粉而形成。 2.75mmX3.5mmX0.7mm。

### 1.2 Features 产品特征

PLCC-2 Package.封装

Extremely wide viewing angle.发光角度大

Suitable for all SMT assembly and solder process.适用于所有的SMT组装和焊接工艺

Available on tape and reel.适用于载带及卷轴

Moisture sensitivity level: Level 3.防潮等级 Level 3

RoHS compliant.满足RoHS要求

### 1.3 Application 产品应用

Optical indicator.光电指示

Indoor display.室内显示

Tubular light application.用于日光灯管

General use.其他应用

Not suitable for lexible strip.不适用于软灯条

## 1.4 Package Dimension 封装尺寸

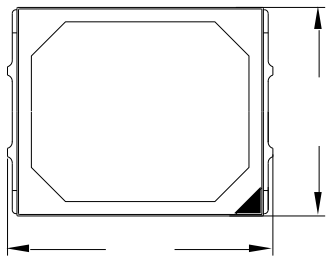

Fig.1-1 Top view 正面视图

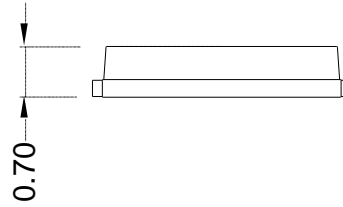

Fig.1-2 Side view 侧面视图

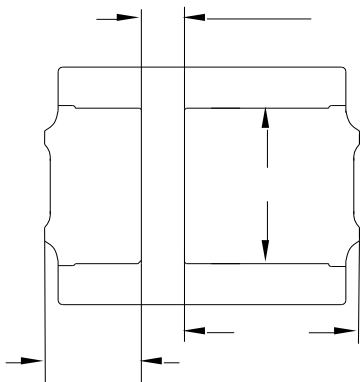

Fig.1-3 Bottom view 背面视图

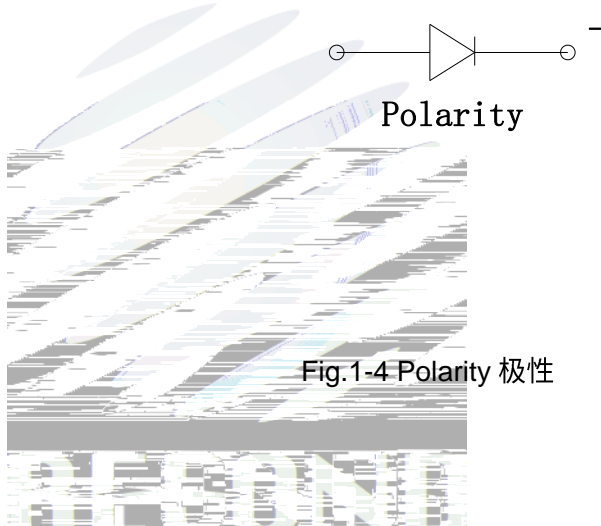

Fig.1-4 Polarity 极性

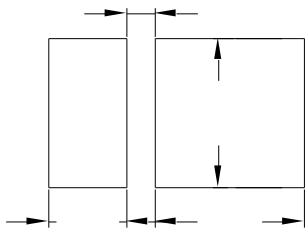

Fig.1-5 Soldering patterns 堆蓋焊盘

### Notes 备注:

1. All dimensions units are millimeters. 所有尺寸标注单位为毫米
2. All dimensions tolerances are  $\pm 0.05\text{mm}$  unless otherwise noted. 除特别标注外, 所有尺寸公差为  $\pm 0.05$  毫米

## 1.5 Product Parameters 产品参数

Table 1-1 Electrical / Optical Characteristics at Ts=25°C 电性与光学特性

Item 项目	Symbol 符号	Test Condition 测试条件	Value			Unit 单位
			Min. (最小值)	Typ (典型值)	Max. (最大值)	
Forward Voltage (正向电压)	VF	IF=60mA	3.0	3.12	3.4	V
Reverse Current (漏电流)	IR	VR=5V	---	---	10	uA
RF-P30MI32DS-AF-N-Y ERP 2780-3110K		IF=60mA	24	25.5	28	lm
RF-P40MI32DS-AF-N-Y ERP 3770-4330K		IF=60mA	26	26.5	28	lm
RF-P57MI32DS-AF-N-Y ANSI 5350-6050K		IF=60mA	26	26.5	28	lm
RF-P60MI32DS-AF-N-Y ERP 5740-6530K		IF=60mA	26	26.5	28	lm
RF-P65MI32DS-AF-N-Y ERP 6050-6950K		IF=60mA	26	26.5	28	lm
Viewing Angle (发光角度)	2θ1/2	IF=60mA	---	120	---	deg
Color Rendering Index (显色指数)	C					

Table 1-2 Absolute Maximum Ratings at Ts=25°C 绝对最大值

Notes 备注:

1. 1/10 Duty cycle, 0.1ms pulse width. 脉宽0.1ms,占空比1/10.
2. The above forward voltage measurement allowance tolerance is  $\pm 0.05V$ . 以上所示电压测量误差  $\pm 0.05V$ .
3. The above color coordinates measurement allowance tolerance is  $\pm 0.005$ . 以上所示坐标测量误差 $\pm 0.005$
4. The above luminous intensity measurement allowance tolerance  $\pm 10\%$ . 上述发光强度的测试允许公差为  $\pm 10\%$ .
5. Care is to be taken that power dissipation does not exceed the absolute maximum rating of the product. 使用功率不能超过规定的最大值。
6. All measurements were made under the standardized environment of Refond. 标准测试平台。
7. When the LEDs are in operation the maximum current should be decided after measuring the package temperature, junction temperature should not exceed the maximum rate. LED 使用的最大电流需要根据散热条件确定，结温不能超过最大值。
8. ESD yield is over 90% at 2000V ESD (HBM). ESD protection during products handing is needed. 90%的LED 通过人体模式ESD2000V 测试，在操作时请注意静电防护。

## 1.6 Bin Range Of Forward Voltage and Luminous Flux (IF=60mA)电压与流明分BIN 范围(IF=60mA)

Table 1-3

V <sub>F</sub> V	H1	H2	I1	I2
	3.0-3.1	3.1-3.2	3.2-3.3	3.3-3.4
Im	QIA			
	26-28			



## 1.7 Typical optical characteristics curves 典型光学特性曲线

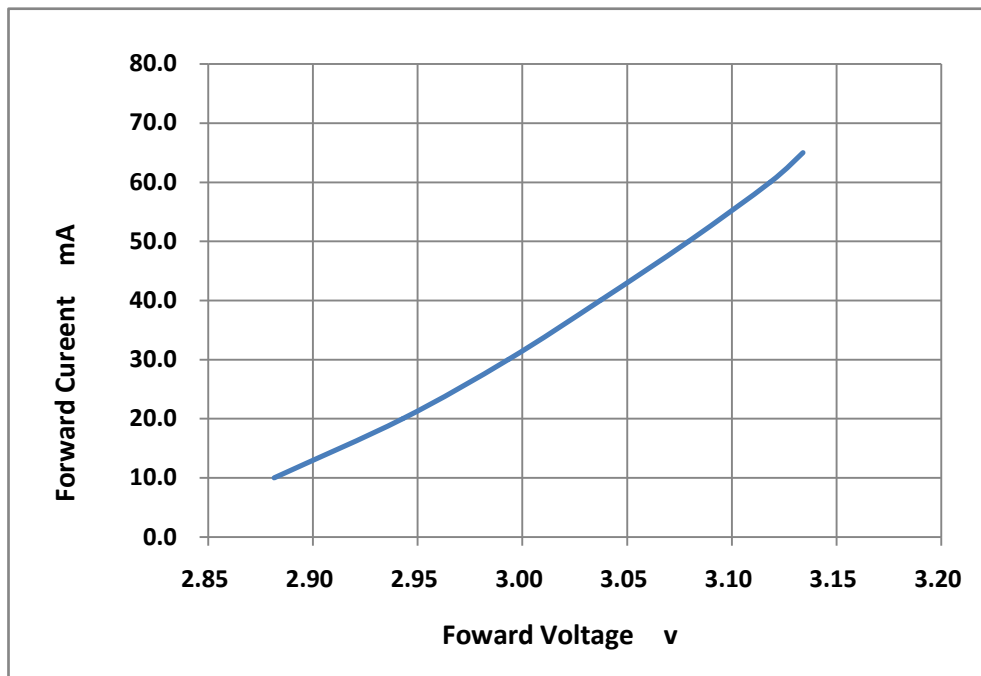

Fig 1-7 Forward Voltage Vs. Forward Current 伏安特性曲线

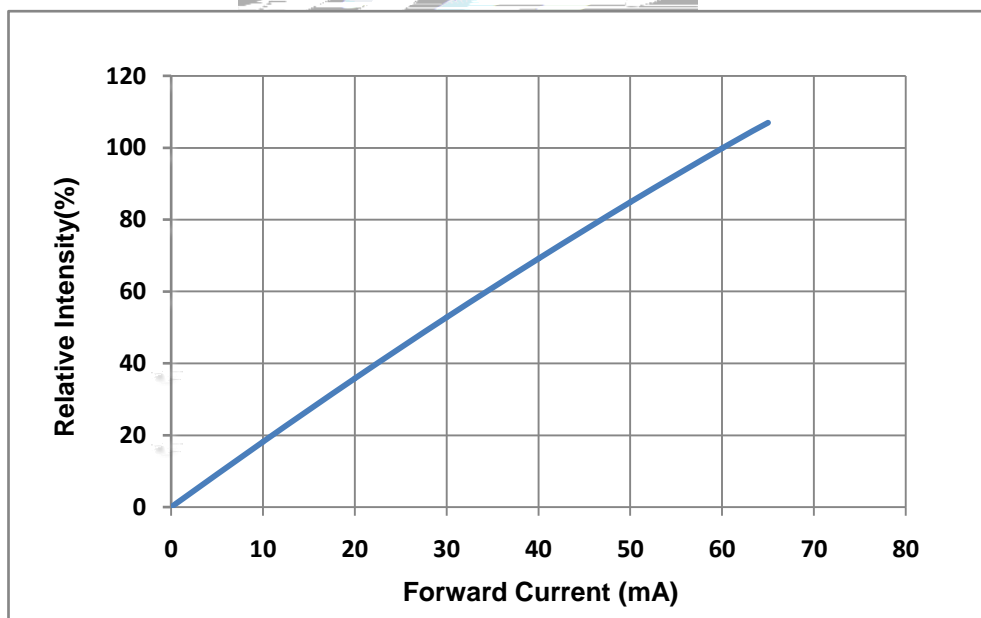

Fig 1-8 Forward Current Vs. Relative Intensity 正向电流与相对光强特性



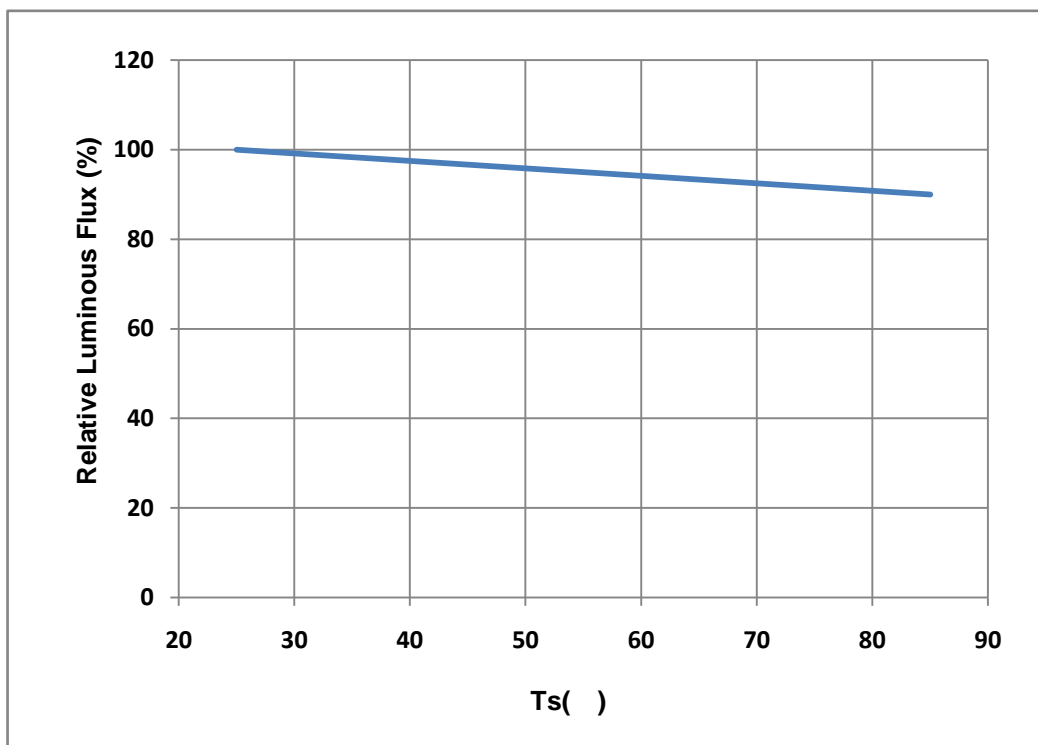

Fig 1-9 Pin Temperature Vs Relative Intensity 管脚温度与相对光强特性曲线

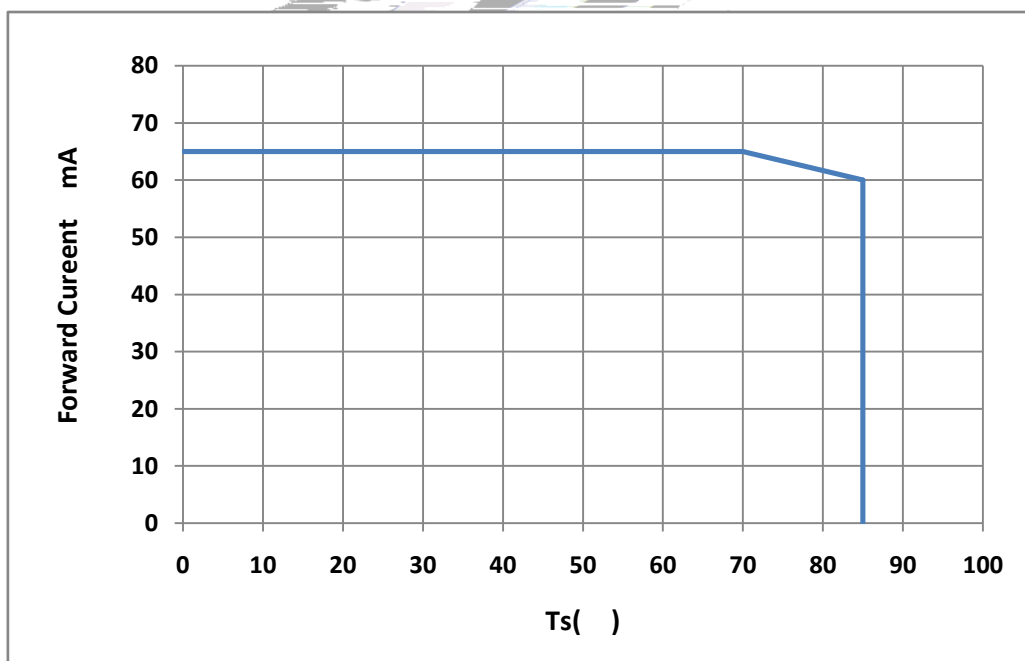

Fig 1-10 Pin Temperature Vs. Forward Current 管脚温度与正向电流特性曲线

$T_j \leq 110^\circ\text{C}$

Fig 1-11 Forward Voltage Vs Pin Temperature 正向电压与管脚温度特性曲线

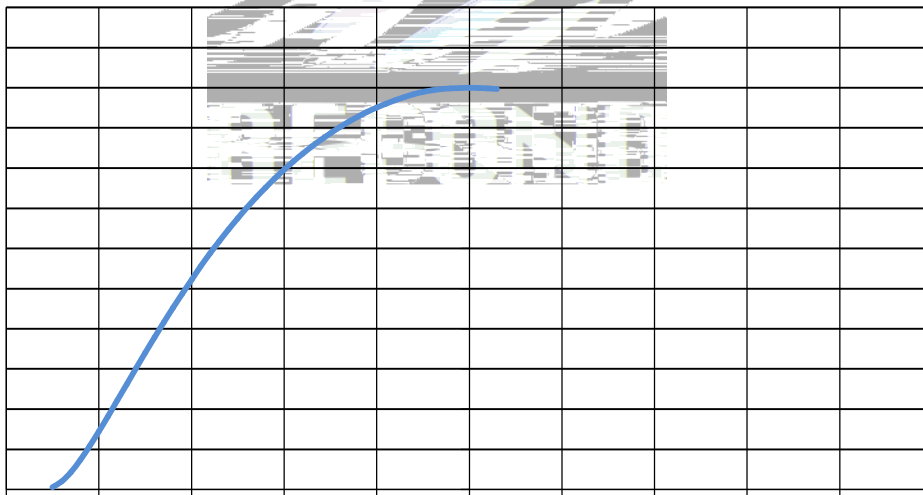

Fig 1-12 Radiation diagram 辐射特性曲线

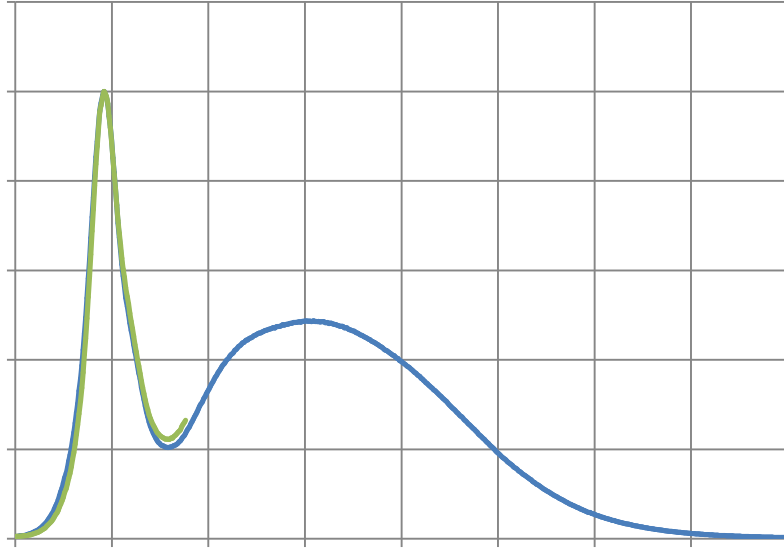

Fig 1-13 Spectrum Distribution 光谱分布特性曲线



## 2. Packaging 产品包装

### 2.1 Packaging Specification 包装规格

Package: 23000pcs/reel. 包装每卷 。

#### 2.1.1 Carrier Tape Dimension 载带尺寸

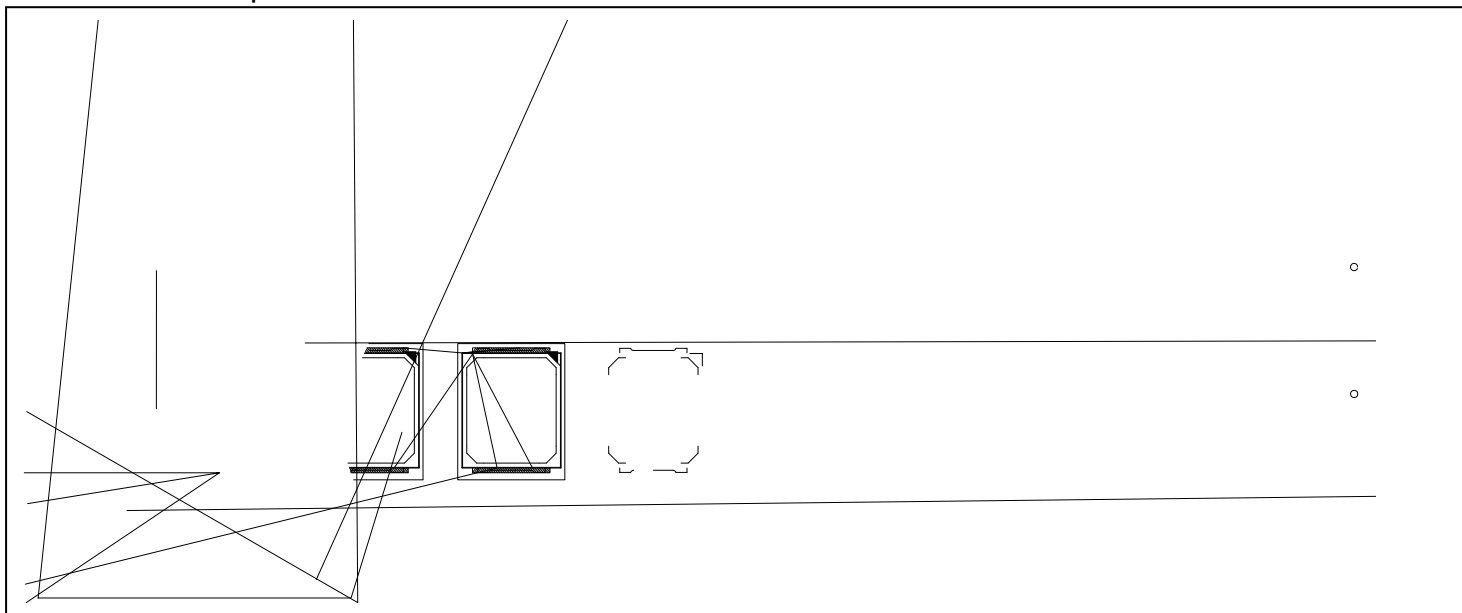

Fig.2-1 Carrier Tape Dimension 载带尺寸

#### 2.1.2 Reel Dimension 卷盘尺寸

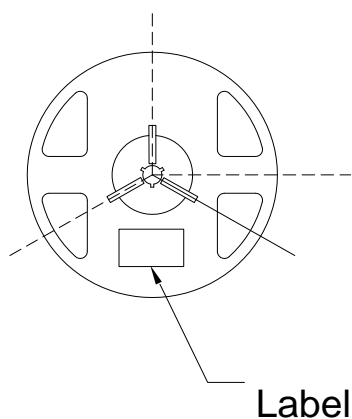

Fig.2-2 Title

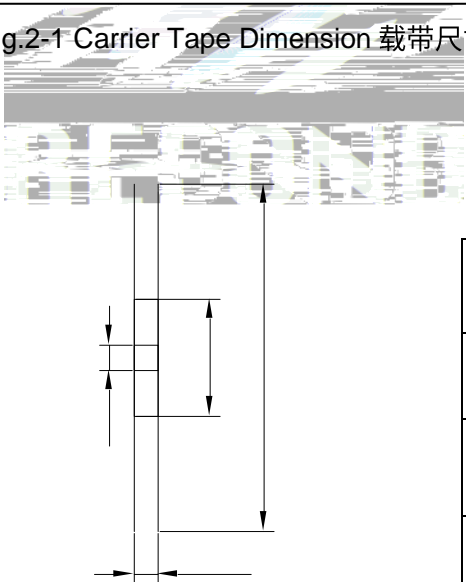

Table 2-1 卷盘尺寸

A	12.4±0.3mm
B	400±2mm
C	100±0.4mm
D	14.3±0.3mm

Notes 备注:

The tolerances unless mentioned ±0.1mm. Unit : mm 注：未注公差为±0.1毫米，尺寸单位：毫米。

### 2.1.3 Label Form Specification 标签规格

Table 2-2 Title

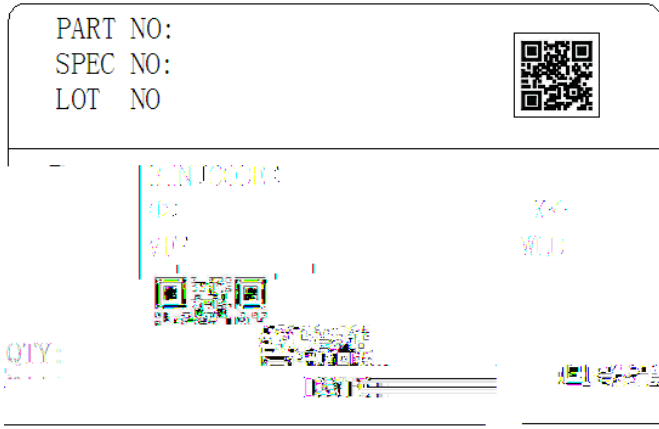

Fig 2-3 Title

PART NO.	Part Number 品名
SPEC NO.	Spec Number 规格
LOT NO.	Lot Number 批次号
BIN CODE	Bin Code 参数代码
	Luminous flux 光通量
XY	Chromaticity Bin 色区
V <sub>F</sub>	Forward Voltage 正向电压
WLD	Wavelength 波长代码
QTY	Packing Quantity 数量
DATE	Made Date 生产日期

### 2.2 Moisture Resistant Packing 防潮包装

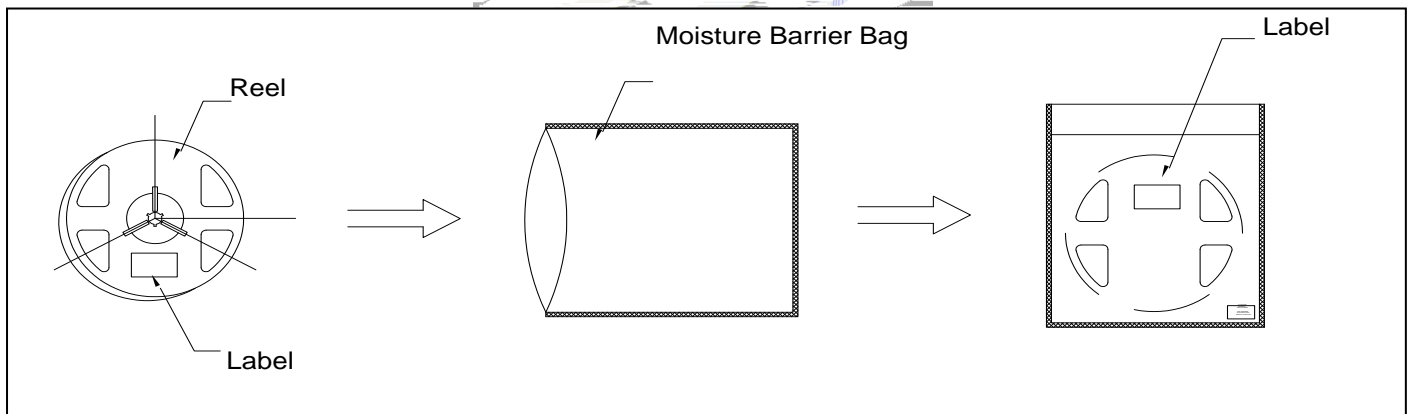

Fig.2- Title

### 2.3 Cardboard Box 包装纸箱

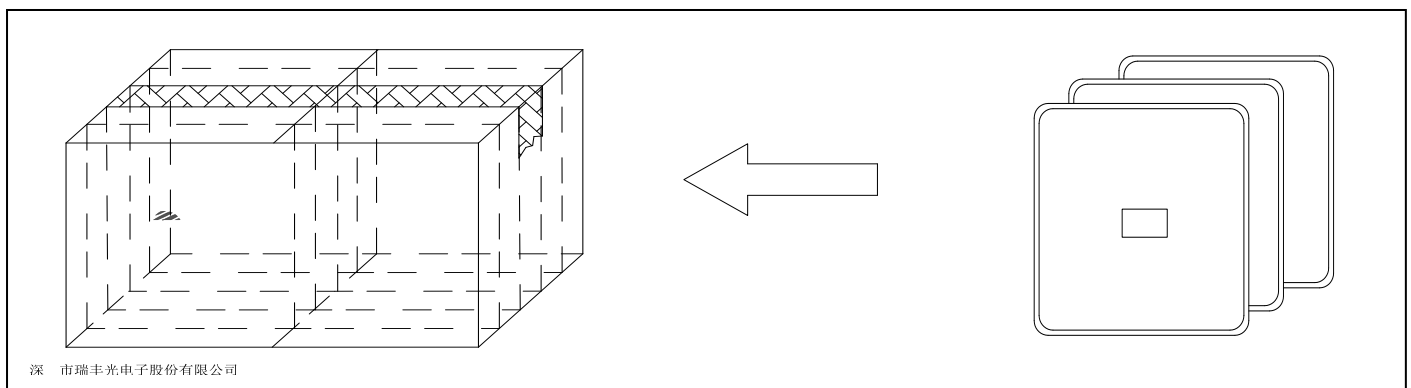

Fig.2- Title

深 市瑞丰光电子股份有限公司

## 2.4 Reliability Test Items And Conditions 信赖性测试项目及条件

Table 2-3 Title

Test Items 项目	Ref. Standard 参考标准	Test Condition 测试条件	Time 时间	Quantity 数量	Ac/Re 接收/拒收
Reflow 回流焊	JESD22-B106	Temp:260°Cmax T=10 sec	2times	20pcs	0/1
Thermal Shock 冷热冲击	JEITAED-4701 300307	-40°C 15min 10s 100°C 15min	160cycles	20pcs	0/1
High Temperature Storage 高温保存	JEITAED-4701 200 201	Temp:100°C	1000hrs	20pcs	0/1
Low Temperature Storage 低温保存	JEITA ED-4701 200 202	Temp:-40°C	1000hrs	20pcs	0/1
Life Test 常温通电	JESD22-A108	Ta=25°C I <sub>F</sub> =60mA	1000hrs	20pcs	0/1
High Temperature High Humidity Life Test 高温高湿通电	JESD22-A101	60°C/ 90%RH I <sub>F</sub> =60mA	500hrs	20pcs	0/1
Temperature Humidity Storage 高温高湿储存	JEITA ED-4701 100 103	T <sub>A</sub> =85°C R <sub>H</sub> =85%	500hrs	20pcs	0/1

## 2.5 Criteria For Judging Damage 失效判定标准

Table 2-4 Title

Test Items 项目	Symbol 符号	Test Condition 测试条件	Criteria For Judgement 判定标准	
			Min. 最小	Max. 最大
Forward Voltage 正向电压	$V_F$	$I_F=60mA$	-	$(U.S.L^*) \times 1.1$
Reverse Current 反向电流	$I_R$	$V_R = 5V$	-	$(U.S.L^*) \times 2.0$
Luminous Flux 光通量		$I_F=60mA$	$(L.S.L^*) \times 0.7$	-

Notes 备注:

1. U.S.L: Upper standard level 规格上限 L.S.L: Lower standard level 规格下限

2. The above reliability tests is based on the verification of a single/strip LED of Refond's existing (ex )Tisti

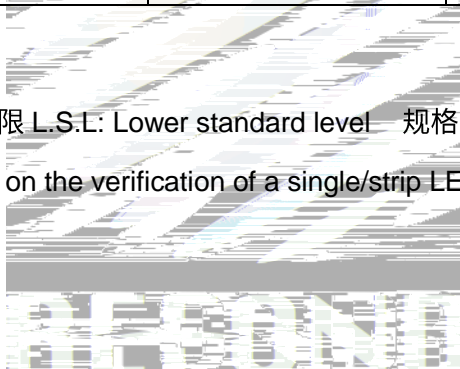

### 3. SMT Reflow Soldering Instructions SMT 回流焊说明

#### 3.1 SMT Reflow Soldering Instructions SMT 回流焊说明

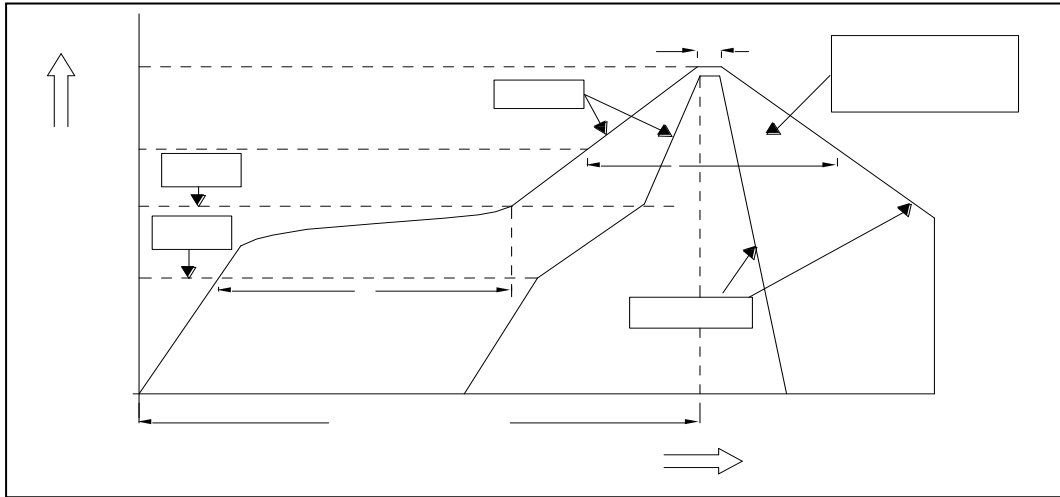

Fig.3-1Title

Table 3-1Title

Average temperature rise speed 平均升温速度 (T <sub>max</sub> 至 T <sub>P</sub> )	最高3 °C/秒 Max 3 °C/ s
Preheating: minimum temperature 预热: 最低温度 (T <sub>min</sub> )	150 °C
Preheating: Max temperature 预热: 最高温度 (T <sub>max</sub> )	200 °C
Preheating: Time 预热: 时间 (T <sub>min</sub> 至 T <sub>max</sub> )	60 - 120秒 60s-120s
Time limited to maintain high temperature: the temperature 限时维持高温: 温度 (T <sub>L</sub> )	217 °C
Time limited to maintain high temperature: The Time 限时维持高温: 时间 (t <sub>L</sub> )	最多60秒 Max 60s
Peak /Classification of temperature: 峰值 / 分类温度 (T <sub>P</sub> )	260 °C
Time limit classification of peak temperature time 限时峰值温度: 时间 (t <sub>p</sub> )	最多10秒 Max 10s
Hold time within 5 °C with the actual peak temperature (T <sub>P</sub> ) 与实际峰值温度 (T <sub>P</sub> ) 相差 5 °C 以内的保持时间	最多30秒 Max 30s
Cooling speed 降温速度	最高6 °C/秒 Max 6 °C/ s
Needed time from 25 °C to T <sub>P</sub> 25 °C 升至峰值温度所需时间	最多8分钟 Max 8 minutes



Notes 备注:

(1) Reflow soldering should not be done more than two times. In the case of more than 24 hours passed soldering after first, LEDs will be damaged. 回流焊次数不可以超过两次，两次回流焊的时间间隔如果超过24小时，LED可能由于吸湿而损坏。

(2) When soldering, do not put stress on the LEDs during heating. 当焊接时，不要在材料受热时用力压胶体表面。

### 3.1.1 Soldering Iron 烙铁焊接

(1) When hand soldering, keep the temperature of iron below less 300°C less than 3 seconds 当手工焊接时，烙铁的温度必须小于300°C，时间不可超过3秒。

(2) The hand solder should be done only one time. 手工焊接只可焊接一次。

### 3.1.2 Repairing 维修

Repair should not be done after the LEDs have been soldered. When repairing is unavoidable, a double-head soldering iron should be used (as below figure). It should be confirmed in advance whether the characteristics of LEDs will or will not be damaged by repairing.

LED 一旦焊后不可再进行维修，维修会损坏LED本身的特性。

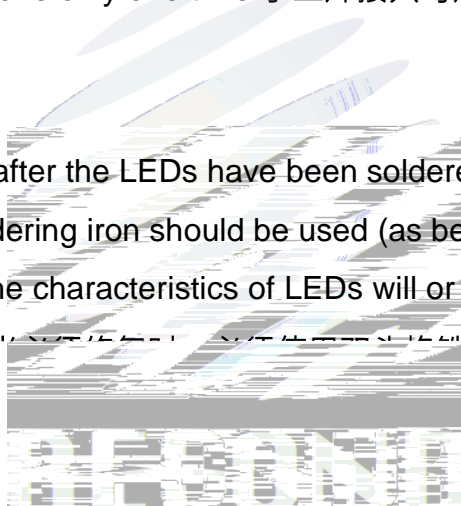

### 3.1.3 Cautions 注意事项

The encapsulated material of the LEDs is silicone. Therefore the LEDs have a soft surface on the top of package. The pressure to the top surface will be influence to the reliability of the LEDs. Precautions should be taken to avoid the strong pressure on the encapsulated part. So when use the picking up nozzle, the pressure on the silicone resin should be proper. LED封装胶为硅胶，表面较软，用力按压时会影响LED可靠性，因此应采取预防措施避免在按压元件，光发射管嘴时，胶体表面的压力应是恰当的。

(2) Components should not be mounted

(3) Do not apply mechanical force or excess vibration during the cooling process to normal temperature after soldering. Do not rapidly cool device after soldering. 回流焊之后冷却过程中，不要对材料施加外力，也不要震动，回流焊后，不要采用激剧冷却的方式。

## 4. Handling Precautions 产品使用注意事项

### 4.1 Handling Precautions 产品使用注意事项

(1) LED operating environment and sulfur element composition cannot be over 100PPM in the LED mating usage material. This is provided for informational purposes only and is not a warranty or endorsement. LED 工作环境及与 LED 适配的材料中硫元素及化合物成份不可超过 100PPM. 这只是一个建议，不作任何品质担保。

(2) In order to prevent external material from getting into the inside of LED, which may cause the malfunction of LED, the single content of Bromine element and Chlorine element in the external materials of the application products is required to be less than 900PPM, the single content of Chlorine element is required to be less than 900PPM, the total content of Bromine element and Chlorine element in the external materials of the application products is required to be less than 1500PPM. This is provided for informational purposes only and is not a warranty or endorsement.

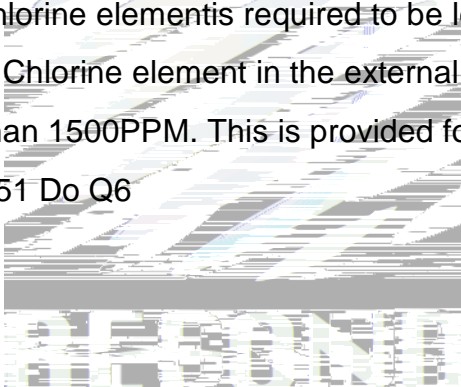

还是仅仅怀疑有需。针对特定的用途和使用环境，瑞丰建议对所有的物质和材料进行相容性的测试。在贴装 LED 时候，不要使用能产生有机挥发性气体的粘结剂。

(4) Handle the component along the side surface by using forceps or appropriate tools; do not directly touch or Handle the silicone lens surface, it may damage the internal circuitry. 通过使用适当的工具从材料侧面夹取，不可直接用手或尖锐金属压胶体表面，它可能会损坏内部电路。

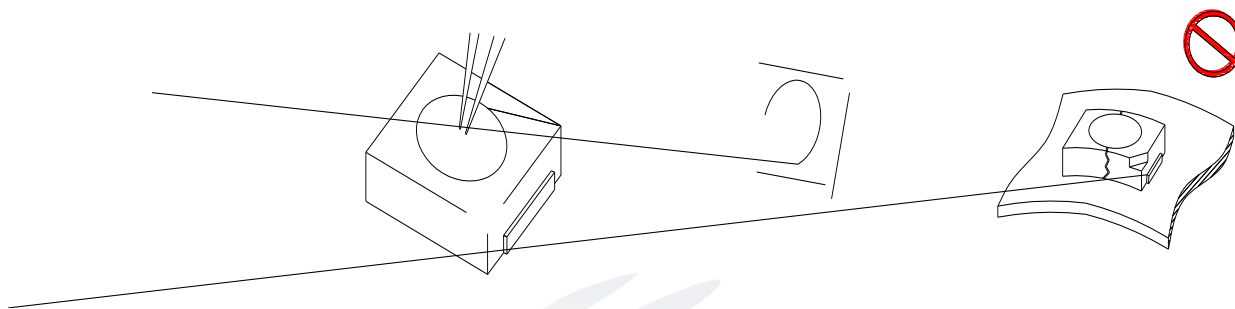

Fig 4-1 Title

(5) In designing a circuit, the current through each LED can not be exceed the absolute maximum rating specified for each LED. In the mean while, resistors for protection should be applied, otherwise slight voltage shift will cause big current change, burn out may happen. The driving circuit must be designed to allow forward voltage only when it is ON or OFF. If the reverse voltage is applied to LED, migration can be generated resulting in LED damage. 设计电路时，通过 LED 的电流不能超过规定的最大值，同时，还需使用保护电阻，否则，微小的电压变化将会引起较大电流变化，可能导致产品损毁。变化，不要施加反压，否则会损坏 LED。

(6) Thermal Design is paramount importance because heat generation may result in the Characteristics decline, such as brightness decreased, Color change and so on. Please consider the heat generation of the LEDs when making the system design. LED 容易因为自身的发热和环境温度的改变而改变，温度升高会降低 LED 发光效率，影响发光颜色，所以在设计时应充分考虑散热问题。

(7) Compared to standard encapsulants, silicone is generally softer, and the surface is more likely to attract dust, requiring special care during processing. In cases where a minimal level of dirt and dust particles cannot be guaranteed, a suitable cleaning solution must be applied to the surface after the soldering of components. Refond suggests using isopropyl alcohol for cleaning. In case

other solvents are used, it must be assured that these solvents do not dissolve the package or resin. Ultrasonic cleaning is not recommended. Ultrasonic cleaning may cause damage to the LED. 在其他封装材料相比，硅胶通常较软，表面易吸附脏物，应用时应特别注意。当对产品洁净度有严格要求时，可采用超声波清洗，但必须确保清洗液不会对硅胶封装材料造成腐蚀。超声波清洗可能会导致硅胶封装材料破裂，从而造成LED封装失效。不建议使用超声波清洗LED封装材料。清洗时应使用适当的溶剂，并确保清洗液不会对硅胶封装材料造成腐蚀。清洗后应彻底干燥，并确保封装材料完好无损。

Table 4-1 Storage 储存

Conditions 种类		Temperature 温度	Humidity 湿度	Time 时间
Storage	Before Opening Aluminum Bag 拆包前	≤30°C	≤75%	Within 1 Year From Date 一年内
	After Opening Aluminum Bag 拆包后	≤30°C	≤60%	24hours 24小时
Baking 烘烤		60±5°C	-	≥24hours 大于24小时

(8) If the package is flatulence or damaged, please notify the sales staff to assist. 如果包装膨胀或破裂，请通知销售人员协助处理。

(9) Similar to most Solid state devices; LEDs are sensitive to Electro-Static Discharge (ESD) and Electrical Over Stress (EOS). 像其他的半导体电子器件一样，LED对静电过流击穿非常敏感，需要做好防护。

(10) Other points for attention, please refer to our relevant information. 其它注意事项请参照瑞丰相关资料。

Date日期	Revisor修订者	Version版本	Verifier审核	Remarks备注
2020-11-19		E0		





www.refond.com



Declare 申明

This specification is written both in English and in Chinese and the latter is formal.

产品规格书以中英文方式书写，若有冲突以中文版本为准。