



.....	3
.....	3
.....	3
.....	3
.....	4
.....	4
.....	7
.....	10
.....	11
.....	11
.....	11
.....	10
.....	12
.....	13
.....	13
.....	14
.....	15
.....	15
.....	17
.....	17





						mcd
						mcd
						mcd
						mcd
						mcd
						μ



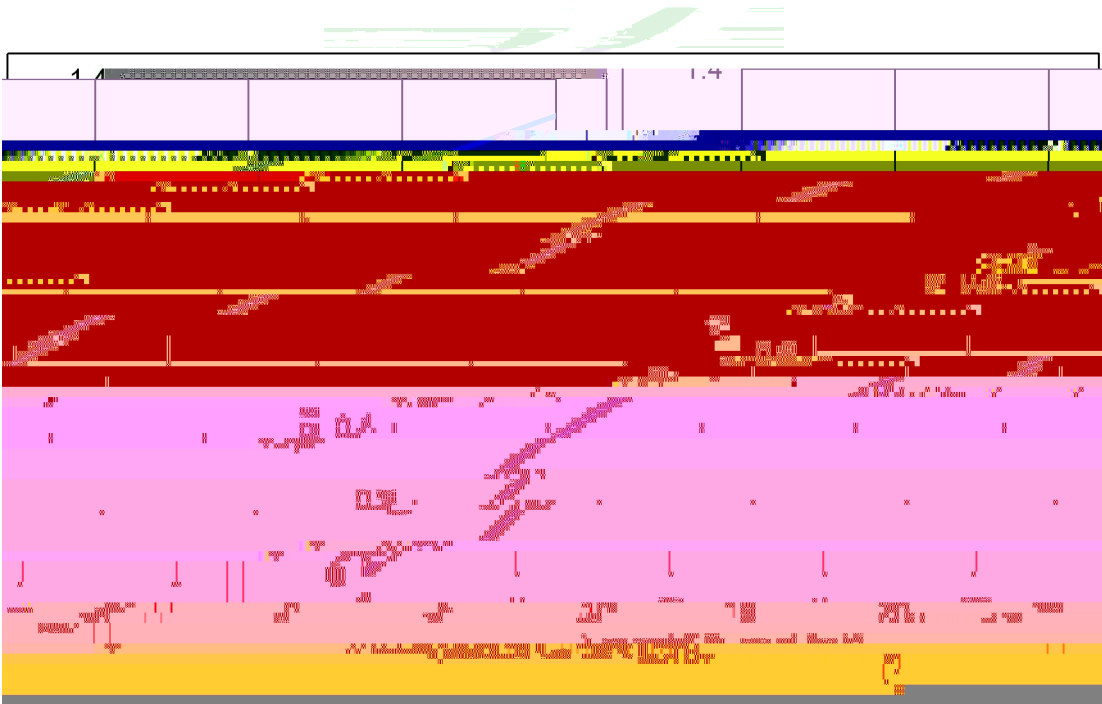
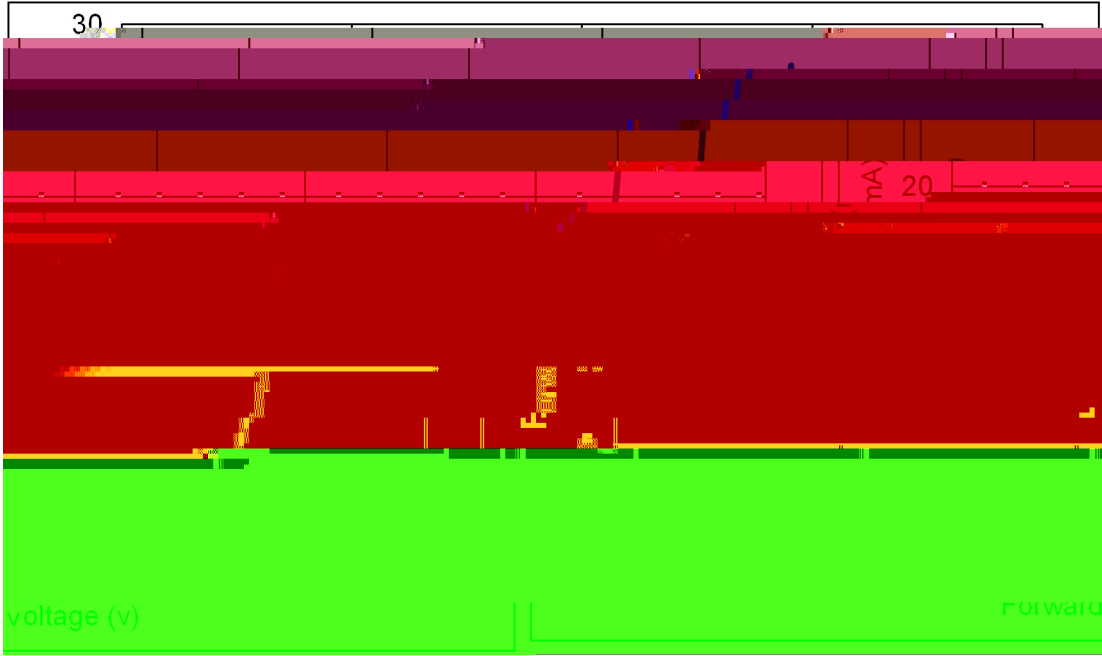

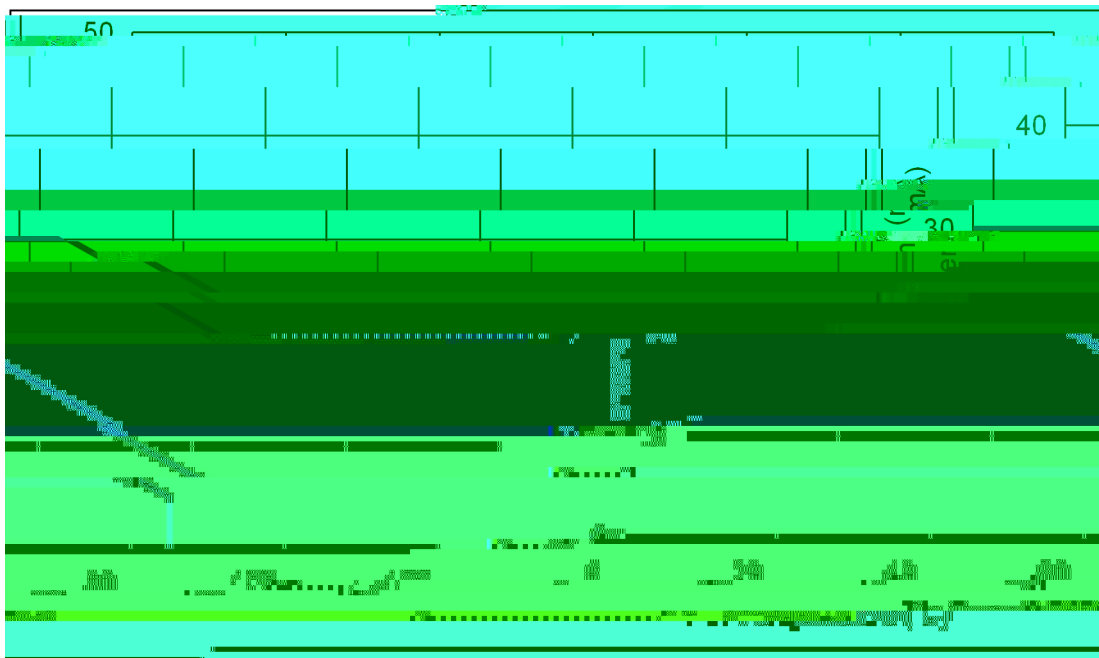
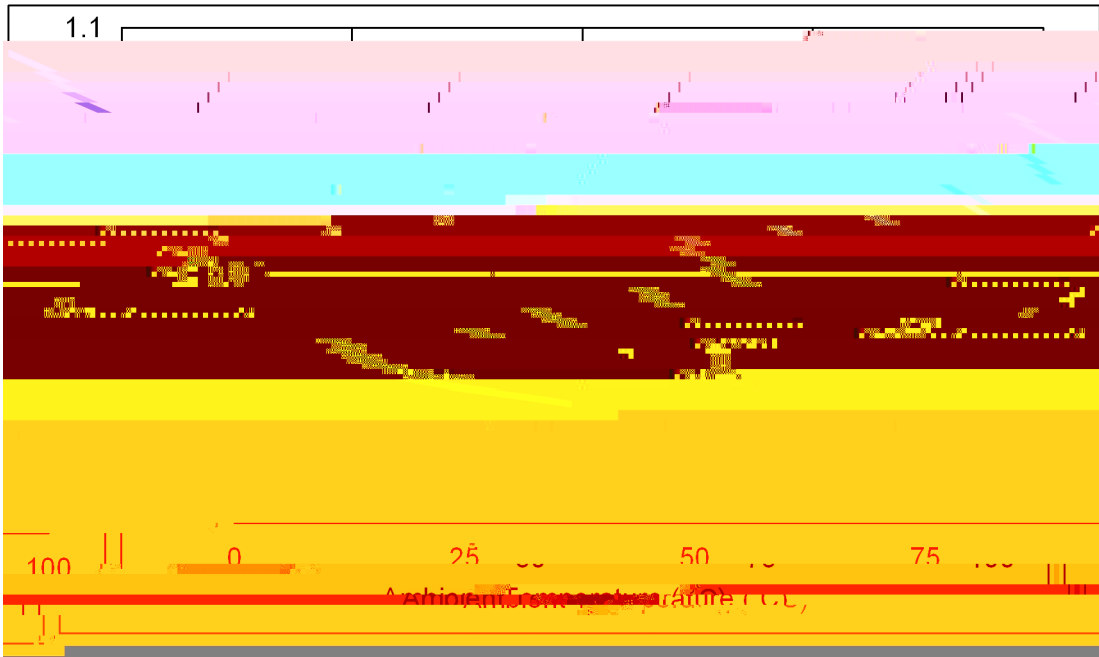
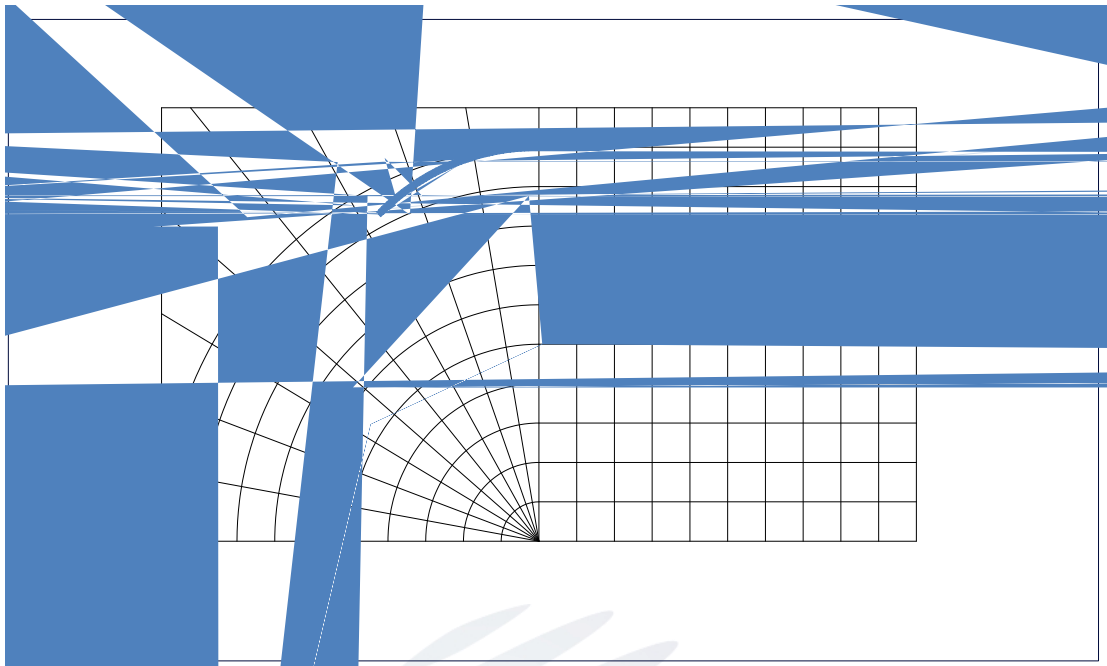

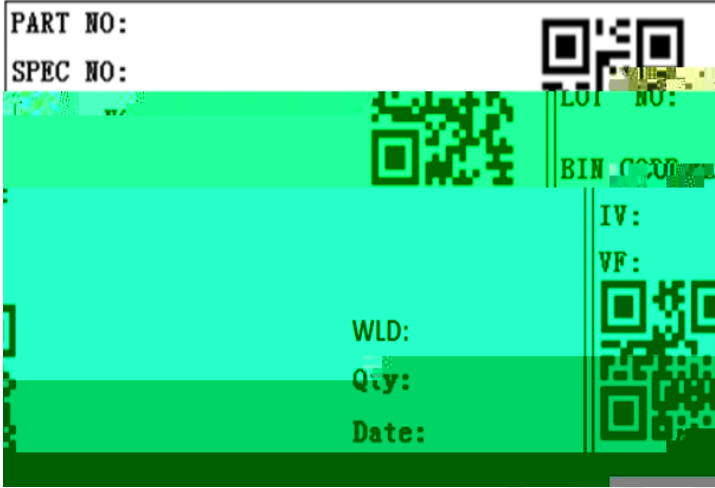

Fig 1-10 Forward Current r









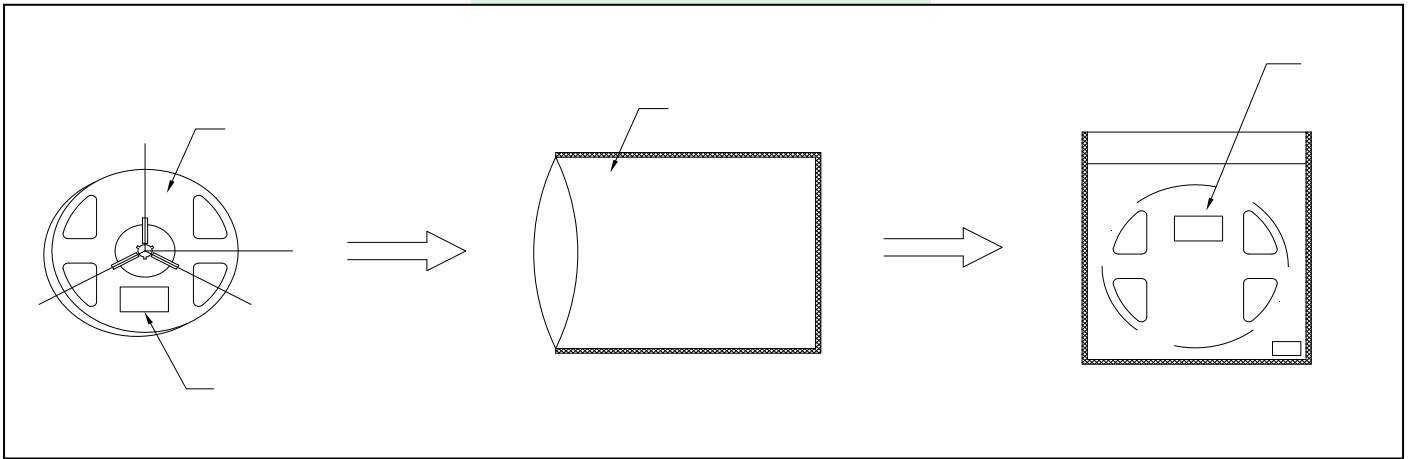

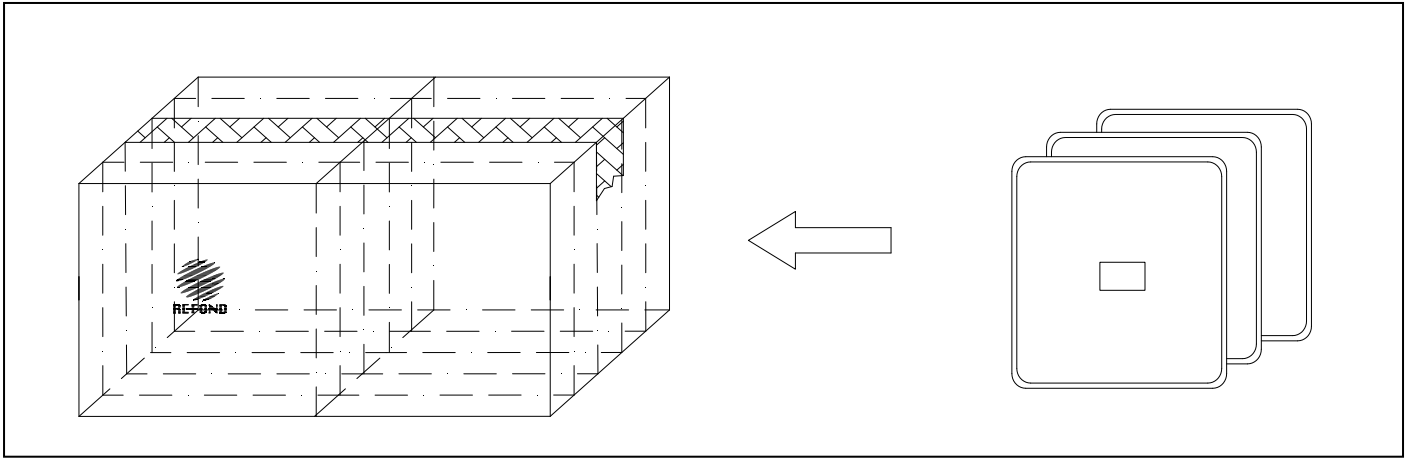







E H

U WHU



