

SPECIFICATION

产品规格书

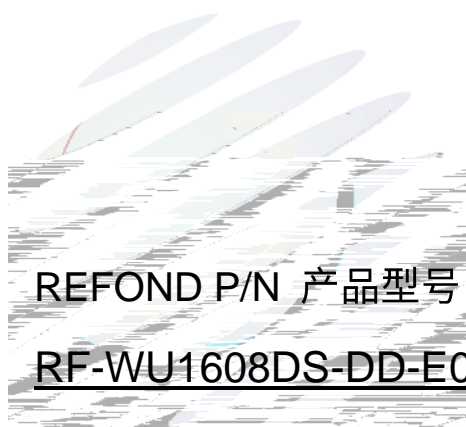

REFOND P/N 产品型号
RF-WU1608DS-DD-E0

R&D 研发

Mass Product 量产供货

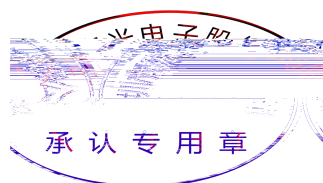



1. Description 产品介绍

1.1 General Description 产品描述

The White LED, which was fabricated by using a blue chip and the phosphor.
Product Package:1.6mmX0.8mmX0.

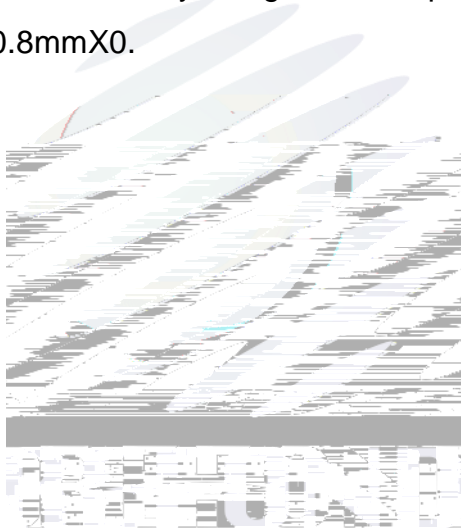

1.4 Package Dimension 封装尺寸

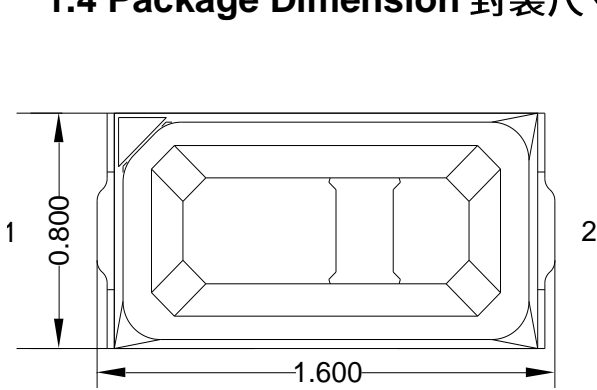

Fig.1-1 Top view 正面视图

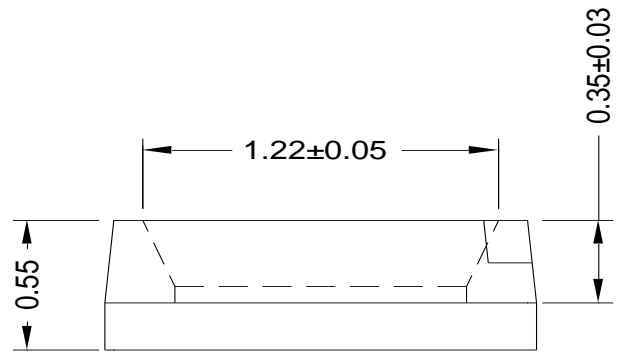

Fig.1-2 Side view 侧面视图

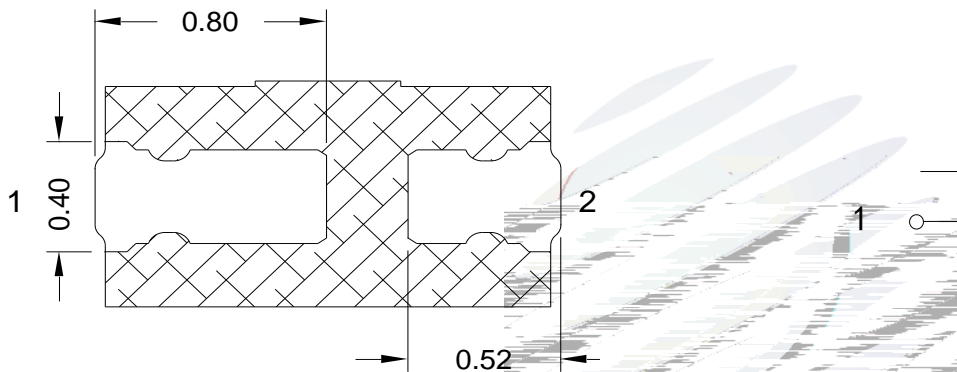

Fig.1-3 Bottom view 背面视图

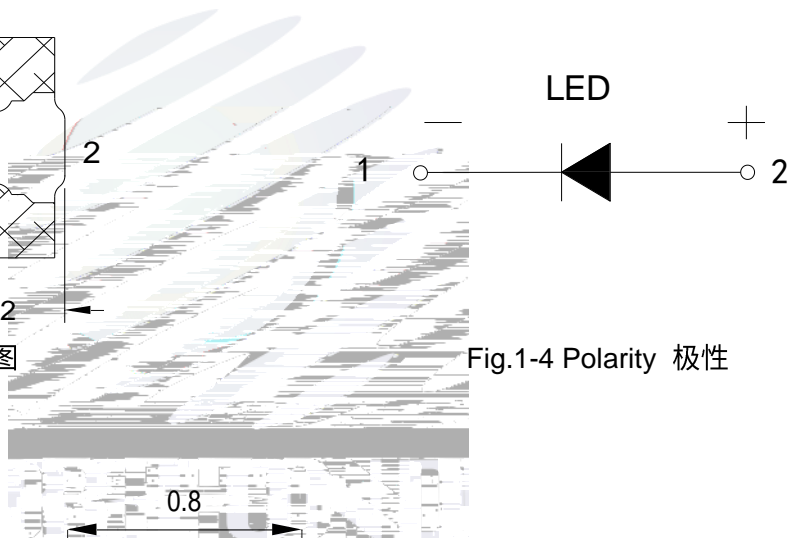

Fig.1-4 Polarity 极性

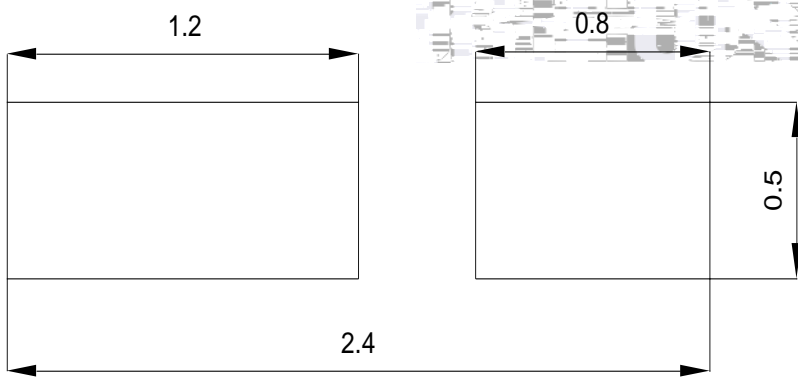
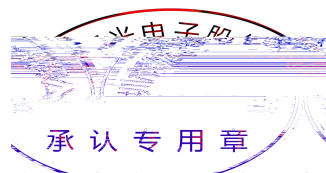

Fig.1-5 Soldering patterns 推荐焊盘

Notes 备注:

1. All dimensions units are millimeters. 所有尺寸标注单位为毫米
2. All dimensions tolerances are $\pm 0.2\text{mm}$ unless otherwise noted. 除特别标注外, 所有尺寸公差为 ± 0.2 毫米



1.5 Product Parameters 产品参数

Table 1-1 Electrical / Optical Characteristics at Ts=25°C 电性与光学特性

Item 项目	Test Condition 测试条件	Symbol 符号	Value			Unit 单位	
			Min. (最小值)	Typ. (典型值)	Max. (最大值)		
Forward Voltage 正向电压	I _F =20mA	V _F	F2	2.7	--	2.8	V
			G1	2.8	--	2.9	V
			G2	2.9	--	3.0	V
			H1	3.0	--	3.1	V
			H2	3.1	--	3.2	V
			I1	3.2	--	3.3	V
			I2	3.3	--	3.4	V
			J1	3.4	--	3.5	V
Luminous Intensity 发光强度	I _F =20mA	I _v	L20	1000	--	1200	mcd
			M10	1200	--	1500	mcd
			M20	1500	--	1800	mcd
			N10	1800	--	2300	mcd
			N20	2300	--	2800	mcd
			O10	2800	--	3500	mcd
Viewing Angle 发光角度	I _F =20mA		--	140	--	deg	
Reverse Current 漏电流	V _R =5V/10ms	I _R	--	--	10	μA	
Thermal Resistance. 热阻	I _F =20mA	R _{THJ-S}	--	--	450	°C/W	

 Notes 备注: V_R=5V For test conditions. V_R=5V 为测试条件.

Table 1-2 Absolute Maximum Ratings at Ts=25°C 绝对最大值

Parameter (参数)	Symbol (符号)	Rating (值)	Units (单位)
Power Dissipation (功耗)	Pd	105	mW
Forward Current (正向电流)	IF	30	mA
Peak Forward Current Of Pulse (脉冲峰值电流)	IFP	60	mA
Electrostatic Discharge (HBM) (静电)	ESD	1000	V
Operating Temperature (操作温度)	Topr	-40 ~ +85	°C
Storage Temperature (储存温度)	Tstg	-40 ~ +85	°C
Junction Temperature (结温)	Tj	95	°C

Notes 备注:

- 1/10 Duty cycle, 0.1ms pulse width. 脉宽0.1ms,占空比1/10.
- The above forward voltage measurement allowance tolerance is $\pm 0.1V$. 以上所示电压测量误差 $\pm 0.1V$.
- The above color coordinates measurement allowance tolerance is ± 0.005 . 以上所示坐标测量误差 ± 0.005 .
- The above luminous intensity measurement allowance tolerance $\pm 10\%$. 上述发光强度的测试允许公差为 $\pm 10\%$.
- Care is to be taken that power dissipation does not exceed the absolute maximum rating of the product. 使用功率不能超过规定的最大值。
- All measurements were made under the standardized environment of Refond. 所有测试都是基于瑞丰现有的标准测试平台。
- When the LEDs are in operation the maximum current should be decided after measuring the package temperature, junction temperature should not exceed the maximum rate. LED使用的最大电流需要根据散热条件确定, 结温不能超过最大值。

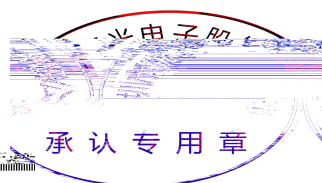
1.6 Bin Range Of Forward Voltage and Luminous Flux (IF=20mA)电压与流明分BIN 范围(IF=20mA)

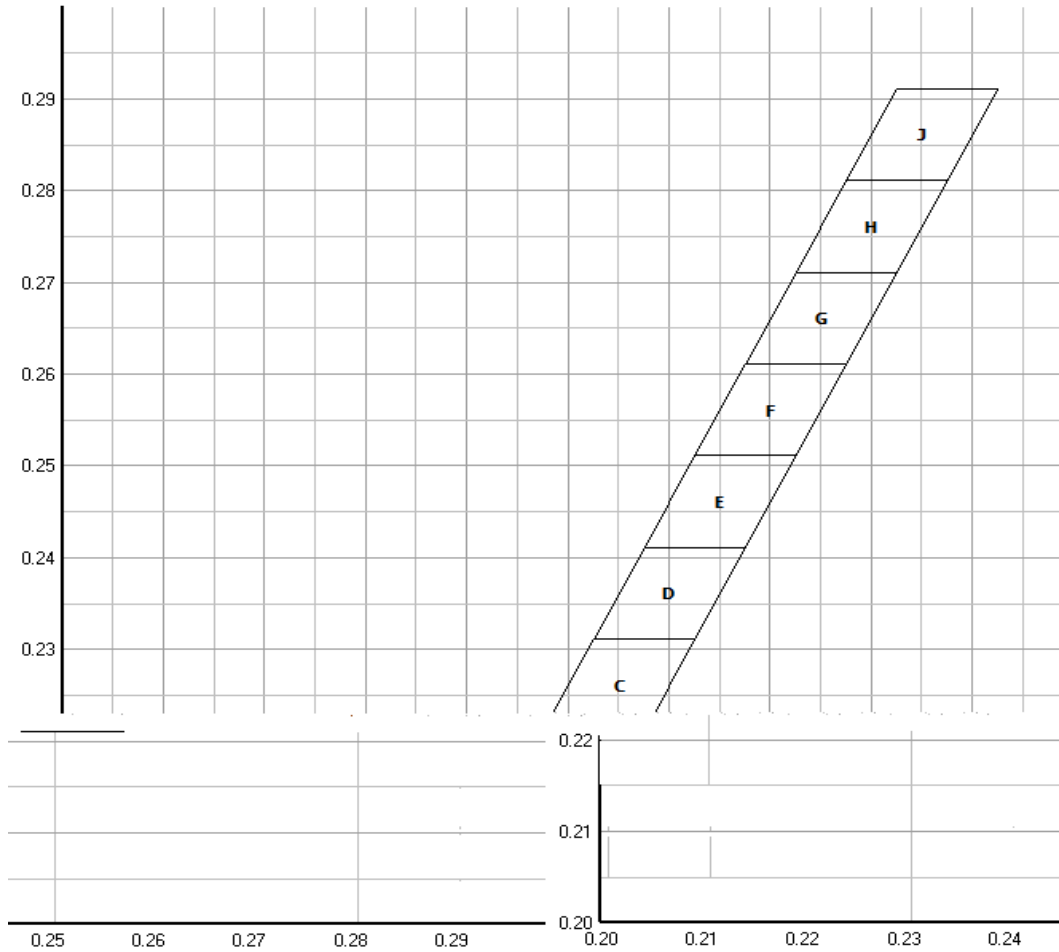

Fig. 1-6 The C.I.E Chromaticity Diagram CIE色度图

Table 1-3 Bin Date Bin数据

BIN	X1	Y1	X2	Y2	X3	Y3	X4	Y4
J	0.2775	0.281	0.2825	0.291	0.2925	0.291	0.2875	0.281
H	0.2725	0.271	0.2775	0.281	0.2875	0.281	0.2825	0.271
G	0.2675	0.261	0.2725	0.271	0.2825	0.271	0.2775	0.261
F	0.2625	0.251	0.2675	0.261	0.2775	0.261	0.2725	0.251
E	0.2575	0.241	0.2625	0.251	0.2725	0.251	0.2675	0.241
D	0.2525	0.231	0.2575	0.241	0.2675	0.241	0.2625	0.231
C	0.2475	0.221	0.2525	0.231	0.2625	0.231	0.2575	0.221

1.7 Typical Optical Characteristics Curves 典型的光学特性曲线

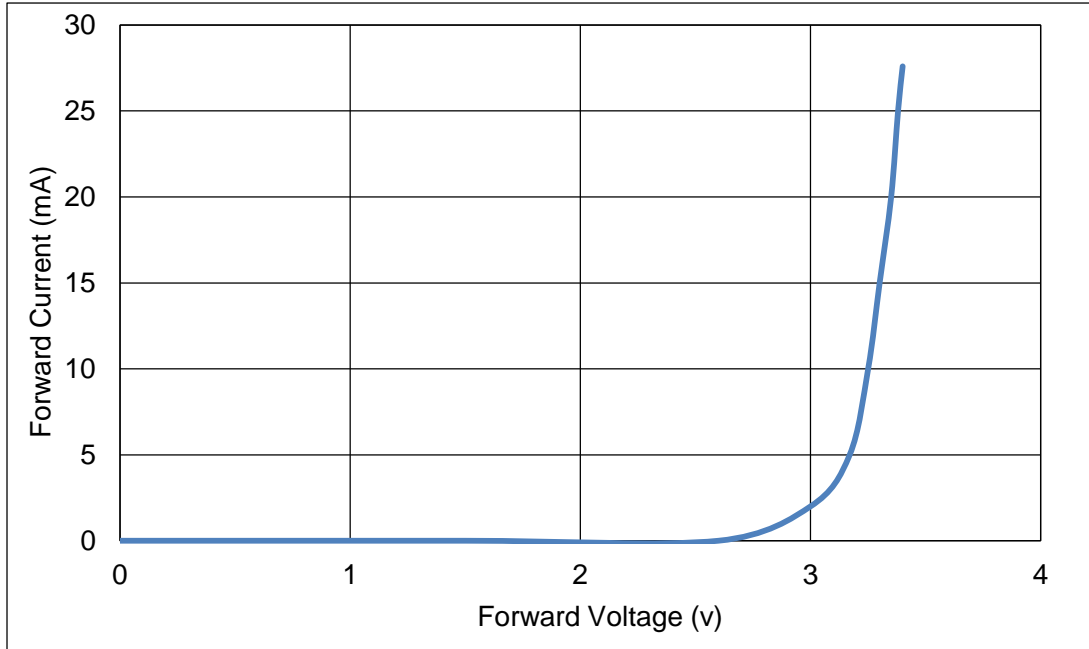

Fig. 1-7 Forward Voltage Vs Forward Current 伏安特性曲线

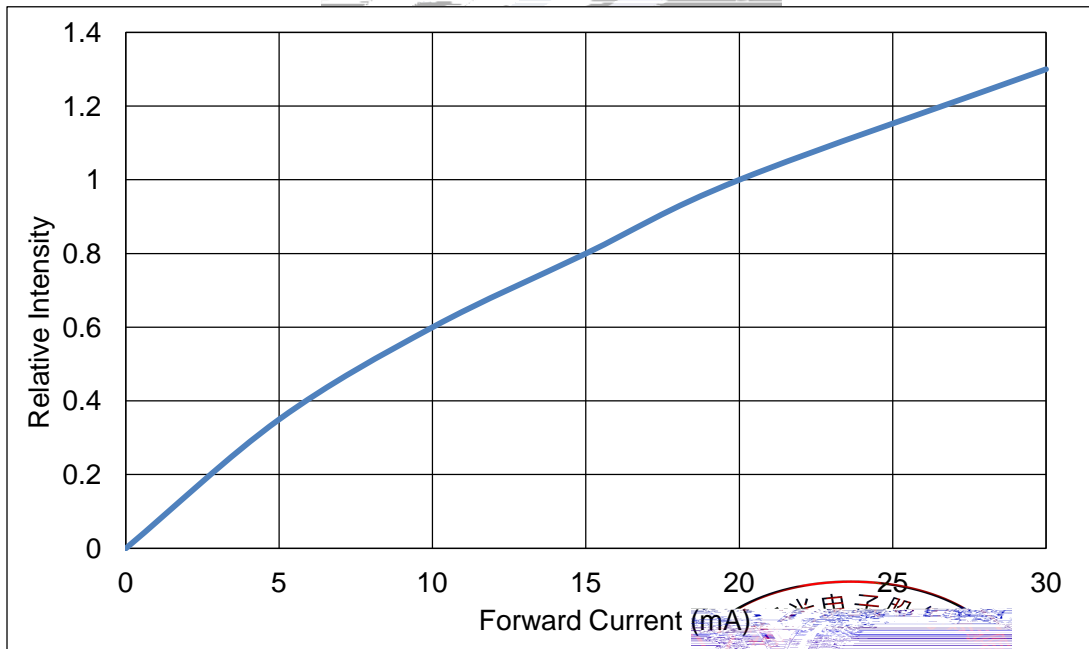

Fig. 1-8 Forward Current Vs Relative Intensity 正向电流与相对光强特性曲线

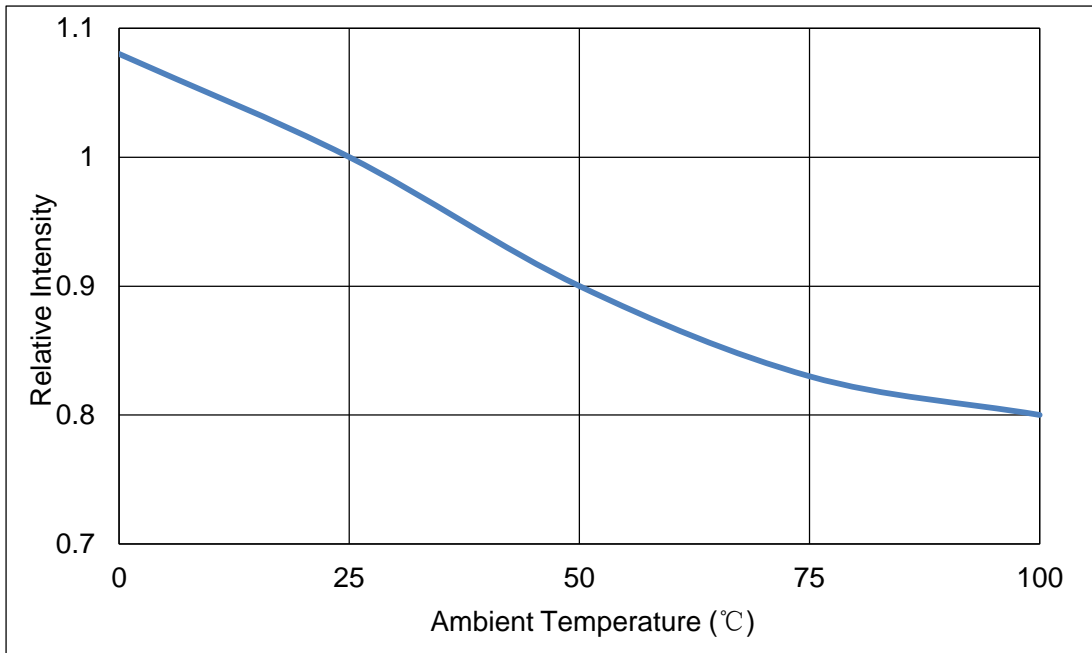

Fig. 1-9 Pin Temperature Vs Relative Intensity 引脚温度与相对光强特性曲线

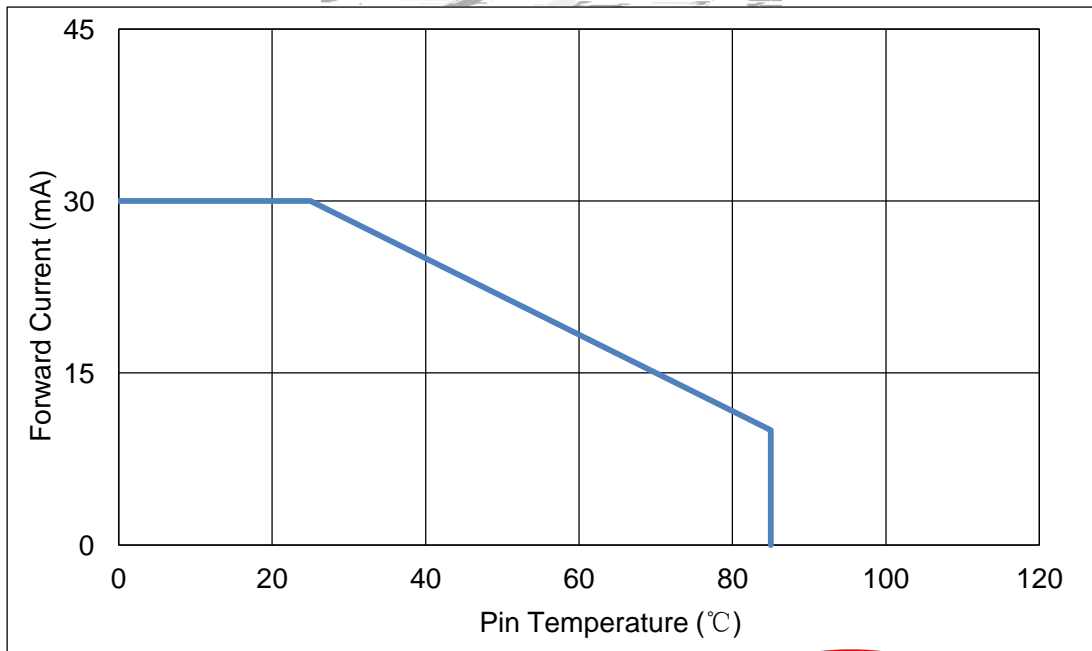
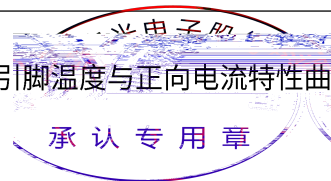

Fig. 1-10 Pin Temperature Vs Forward Current 引脚温度与正向电流特性曲线



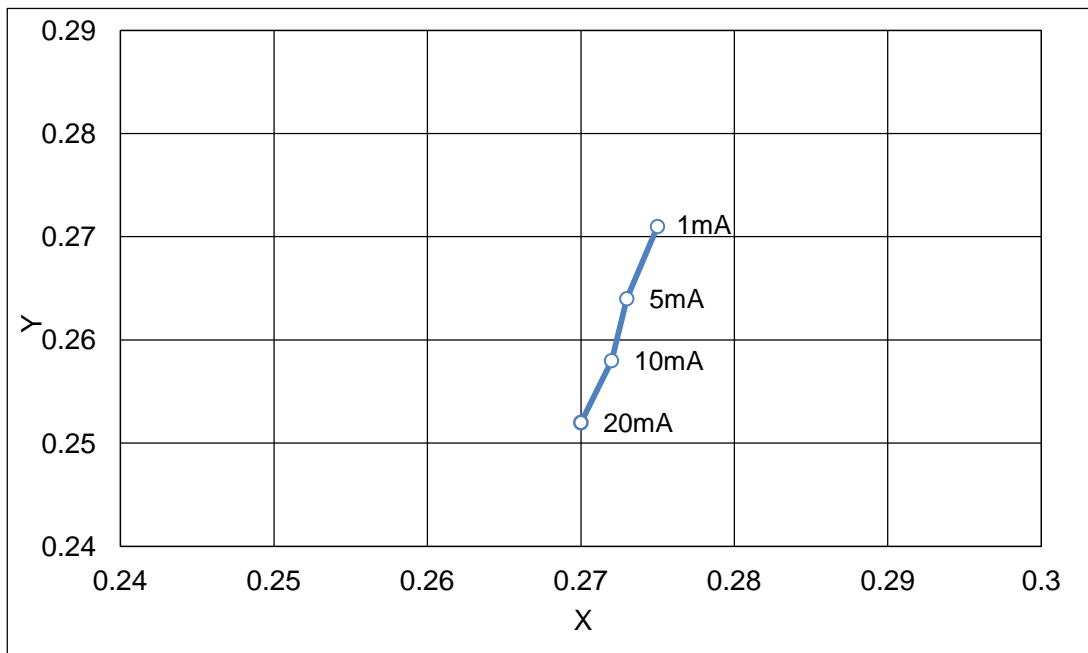

Fig. 1-11 Forward Current Vs Dominate Wavelength (Ta=25°C) 正向电流与主波长关系曲线

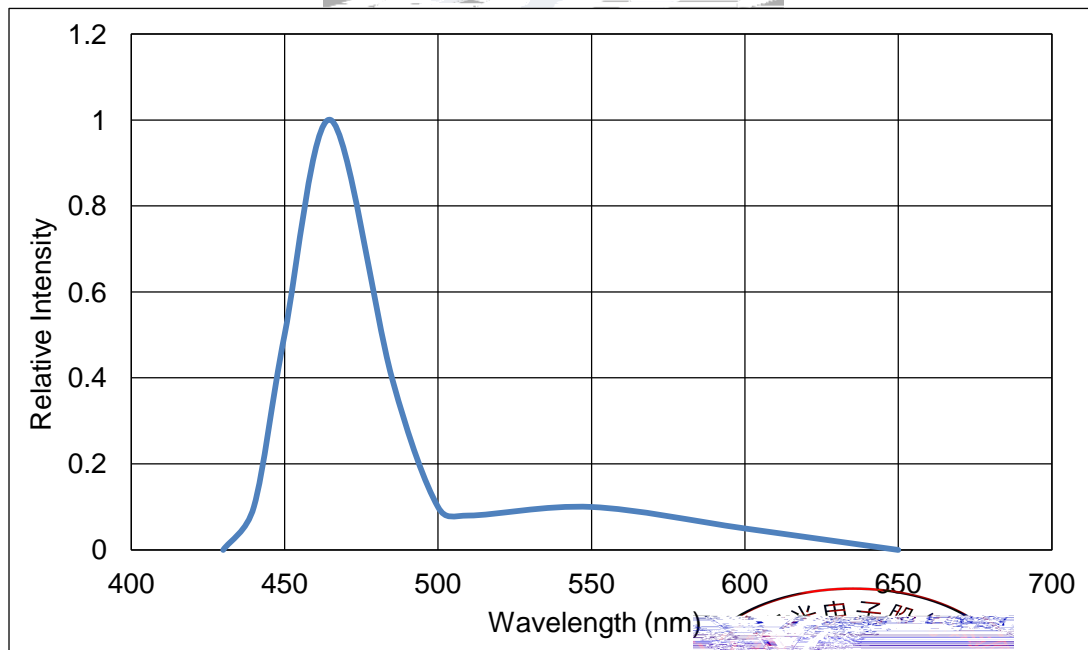
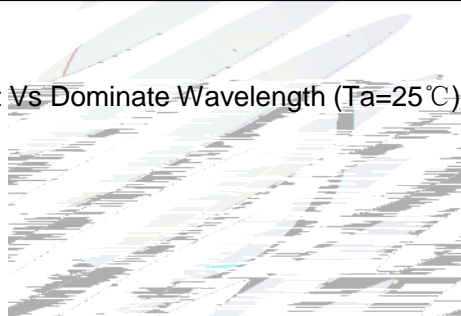
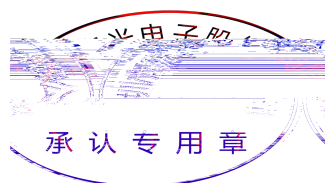

Fig. 1-12 Relative Intensity Vs Wavelength (Ta=25°C) 相对光强与波长关系曲线



2. Packaging 产品包装

2.1 Packaging Specification 包装规格

Package:4000pcs/reel.包装每卷 4000pcs。

2.1.1 Carrier Tape Dimension 载带尺寸

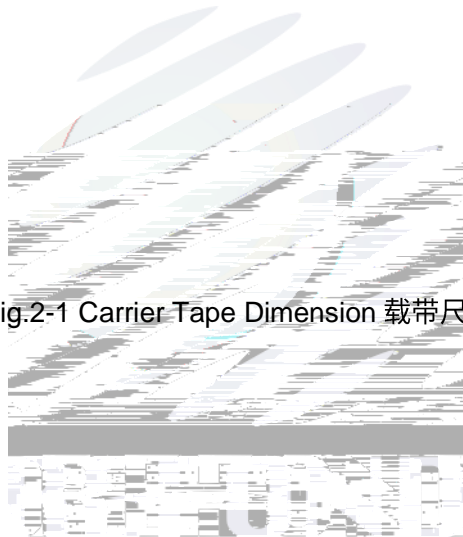

Fig.2-1 Carrier Tape Dimension 载带尺寸

2.1.2 Reel Dimension 卷盘尺寸

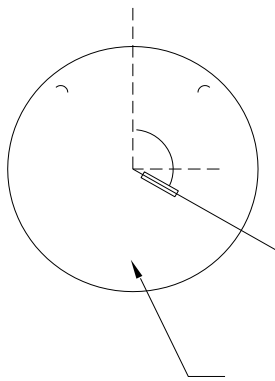

Fig.2-2 Reel Dimension 卷盘尺寸

Table 2-1 Dimension 尺寸

A	8.0±0.1mm
B	178±1mm
C	60±1mm
D	13.0±0.5mm

Notes 备注:

The tolerances unless mentioned ±0.1mm. Unit : mm. 注：未注公差为±0.1毫米，尺寸单位：毫米。

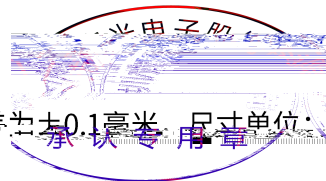

2.1.3 Label Form Specification 标签规格

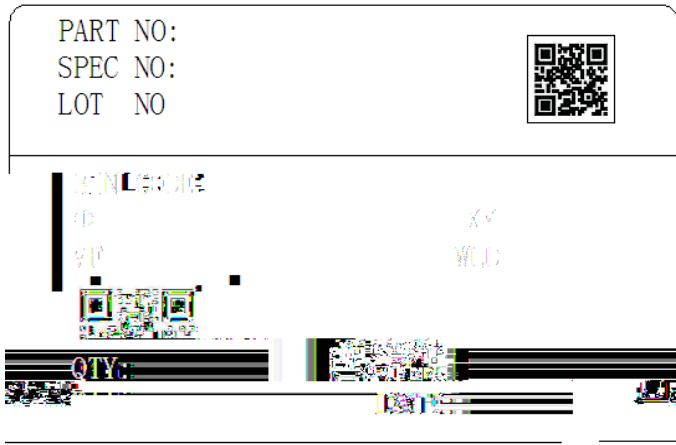

Fig. 2-3 Label Form Specification 标签规格

Table 2-2 Parameter 参数

PART NO.	Part Number 品名
SPEC NO.	Spec Number 规格
LOT NO.	Lot Number 批次号
BIN CODE	Bin Code 参数代码
	Luminous flux 光通量
XY	Chromaticity Bin 色区
V _F	Forward Voltage 正向电压
WLD	Wavelength 波长代码
QTY	Packing Quantity 数量
DATE	Made Date 生产日期

2.2 Moisture Resistant Packing 防潮包装

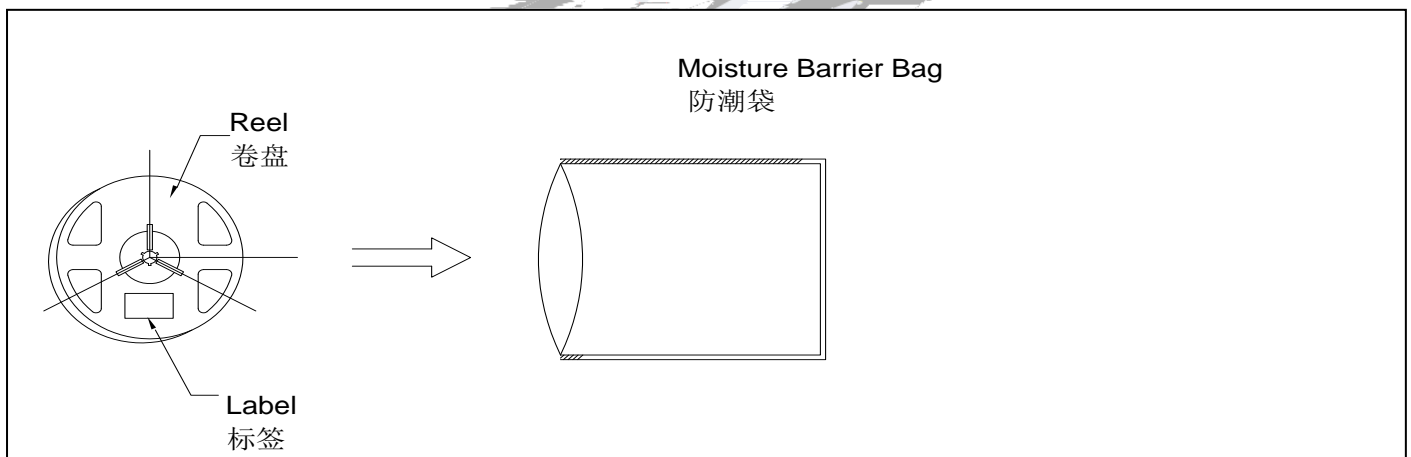
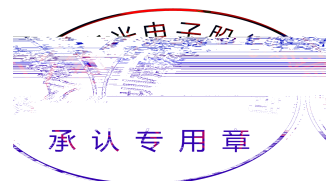

Fig.2-4 Moisture Resistant Packing 防潮包装



2.5 Criteria For Judging Damage 失效判定标准

Table 2-4 Criteria For Judging Damage 失效判定标准

Test Items 项目	Symbol 符号	Test Condition 测试条件	Criteria For Judgement 判定标准	
			Min. 最小	Max. 最大
Forward Voltage 正向电压	V_F	$I_F=20mA$	-	U.S.L*)x1.1
Reverse Current 漏电流	I_R	$V_R= 5V$	-	U.S.L*)x2.0
Luminous Flux 光通量		$I_F=20mA$	L.S.L*)x0.7	-

Notes 备注:

1.U.S.L: Upper standard level 规格上限 L.S.L: Lower standard level 规格下限

2.The above reliability tests is based on the verification of a single/strip LED of Refond's existing experimental platform,the reliability experiment was taken under good heat dissipation conditions. When customers applies the LED to the series and parallel circuit,should take consideration of all the factors such as the current, voltage distribution, heat dissipation and others. 以上可靠性测试是基于瑞丰现有实验平台单颗/条 LED 在良好散热条件验证下的结果。客户端将 LED 应用于串、并联线路时,需自行评估电流、电压分配、散热等问题。

3.The technical information shown in the data sheets is limited to the typical characteristics and circuit examples of the referenced products. It does not constitute the warranting of industrial property nor the granting of any license. 以上技术数据仅为产品的典型值,只作为参考,不作为任何应用条件及应用方式的保证。

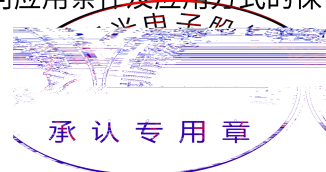

3. SMT Reflow Soldering Instructions SMT

3.1 SMT Reflow Soldering Instructions SMT 回流焊说明

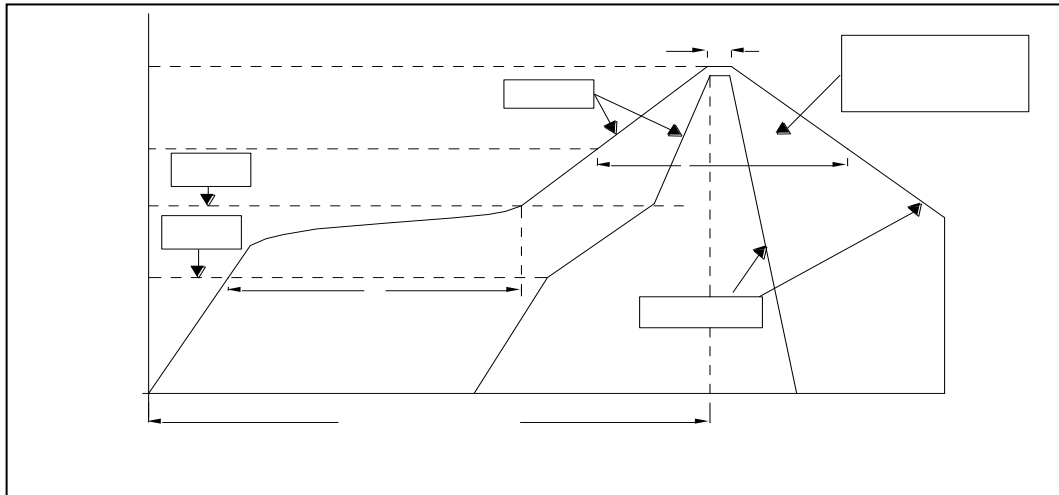

Fig.3-1 SMT Reflow Soldering Instructions SMT 回流焊说明

Table 3-1 Parameter 参数

Average temperature rise speed 平均升温速度 (T _{max} 至 T _P)	最高3 °C/秒 Max 3 °C/ s
Preheating: minimum temperature 预热: 最低温度 (T _{min})	150 °C
Preheating: Max temperature 预热: 最高温度 (T _{max})	200 °C
Preheating: Time 预热: 时间 (T _{min} 至 T _{max})	60 - 120秒 60s-120s
Time limited to maintain high temperature: the temperature 限时维持高温: 温度 (T _L)	217 °C
Time limited to maintain high temperature: The Time 限时维持高温: 时间 (t _L)	最多60秒 Max 60s
Peak /Classification of temperature: 峰值 / 分类温度 (T _P)	260 °C
Time limit classification of peak temperature time 限时峰值分类温度: 时间 (t _p)	最多10秒 Max 10s
Hold time within 5 °C with the actual peak temperature (TP) 与实际峰值温度 (TP) 相差 5 °C 以内的保持时间	最多30秒 Max 30s
Cooling speed 降温速度	最高6 °C/秒 Max 6 °C/ s
Needed time from 25 °C to T _p 25 °C 升至峰值温度所需时间	最多8分钟 Max 8 minutes

Notes 备注

(1) Reflow soldering should not be done more than twice. If more than 24 hours between the two solderings, LED will be damaged. 回流焊次数不可以超过两次，两次回流焊的时间间隔如果超过24小时，LED可能由于吸湿而损坏。

(2) When soldering, do not put stress on the LEDs during heating. 当焊接时，不要在材料受热时用外力压胶体表面。

3.1.1 Soldering Iron 烙铁焊接

(1) When do soldering by hand, keep the temperature of iron below less 300°C less than 3 seconds 当手工焊接时，烙铁的温度必须小于300°C，时间不可超过3秒。

(2) Soldering by hand should be done only one time. 手工焊接只可焊接一次。

3.1.2 Repairing 维修

Repairing should not be done after the LEDs have been soldered. When repairing is unavoidable, a double-head soldering iron should be used (as below figure). It should be confirmed in advance whether the characteristics of LEDs will or not be damaged by repairing.

LED 回流焊后不可再进行维修，当维修不可避免时，应使用双头烙铁（如下图所示），维修前应先确认维修是否会损坏LED本身的特性。

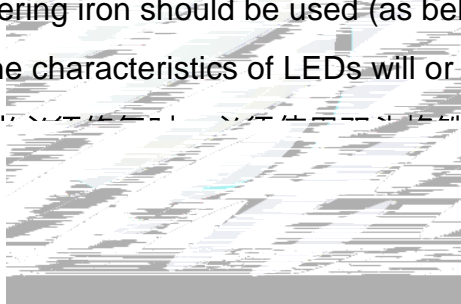

3.1.3 Cautions 注意事项

(1) Components should not be mounted on warped (non coplanar) portion of PCB. After soldering, do not warp the circuit board. LED 灯珠不要焊接在弯曲的PCB板上，焊接之后，也不要弯折线板。

(2) Do not apply mechanical force or excess vibration during the cooling process to normal temperature after soldering. Do not rapidly cool device after soldering. 回流焊之后冷却过程中，不要对材料施加外力，也不要震动，回流焊后，不要采用激剧冷却的方式。

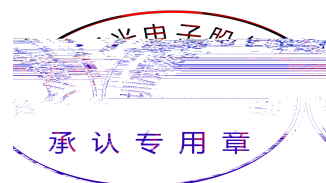

4. Handling Precautions 产品使用注意事项

4.1 Handling Precautions 产品使用注意事项

(1) LED operating environment and sulfur element composition cannot be over 100PPM in the LED mating usage material. This is provided for informational purposes only and is not a warranty or endorsement. LED 工作环境及与 LED 适配的材料中硫元素及化合物成份不可超过 100PPM. 这只是一个建议，不作任何品质担保。

(2) In order to prevent external material from getting into the inside of LED, which may cause the malfunction of LED, the single content of Bromine element is required to be less than 900PPM, the single content of Chlorine element is required to be less than 900PPM, the total content of Bromine element and Chlorine element in the external materials of the application products is required to be less than 1500PPM. This is provided for informational purposes only and is not a warranty or endorsement. 为了防止外界物质进入 LED 内部以造成 LED 的损伤，所处环境及所用套件等等，单一的溴元素含量要求小于 900PPM，单一氯元素含量要求小于 900PPM，溴元素与氯元素总含量必须小于 1500PPM. 这只是一个建议，不作任何品质担保。

(3) VOCs (Volatile organic compounds) emitted from materials used in the construction of fixtures can penetrate silicone encapsulants of LEDs and discolor when exposed to heat and photonic energy. The result can be a significant loss of light output from the fixture. Knowledge of the properties of the materials selected to be used in the construction of fixtures can help prevent these issues. Refond advises against the use of any chemicals or materials that have been found or are suspected to have an adverse affect on device performance or reliability. To verify compatibility, Refond recommends that all chemicals and materials be tested in the specific application and environment for which they are intended to be used. Attaching LEDs, do not use adhesives that outgas organic vapor.

LED 内部，在通电产生光子及热的条件下，会导致 LED 变色，进而造成严重光衰，提前了解套件材料能够避免产生这些问题。瑞丰反对使用任何对 LED 器件的性能或者可靠性有害的物质或材料，不管这些材料是已经证实了的，还是仅仅怀疑有害。针对特定的用途和使用环境，瑞丰建议对所有物质和材料进行相容性的测试。在贴装 LED 时候，不要使用能产生有机挥发性气体的粘结剂。

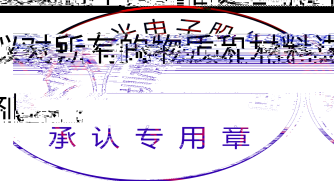





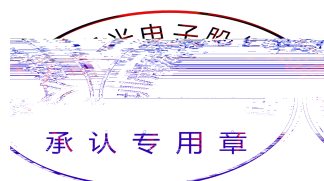

Declare 申明

This specification is written both in English and in Chinese and the latter is formal.

产品规格书以中英文方式书写，若有冲突以中文版本为准。