

.....

.....

.....

.....

.....

.....

.....

.....

.....

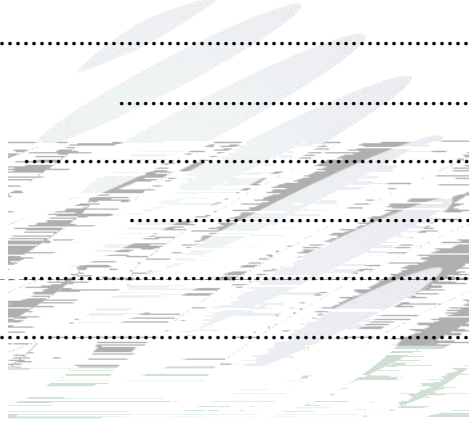

..... 11

..... 11

..... 12

A D U S E R D U G

7 8 1 2 3 4

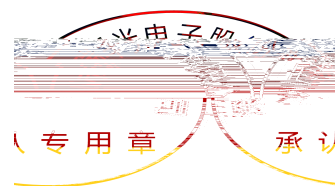
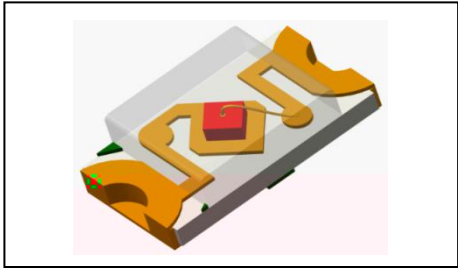

150X200

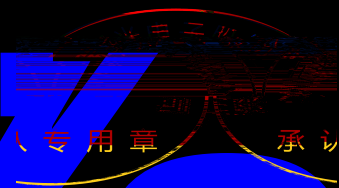



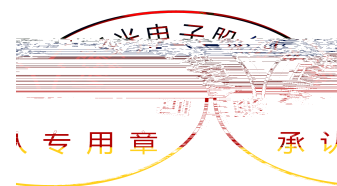

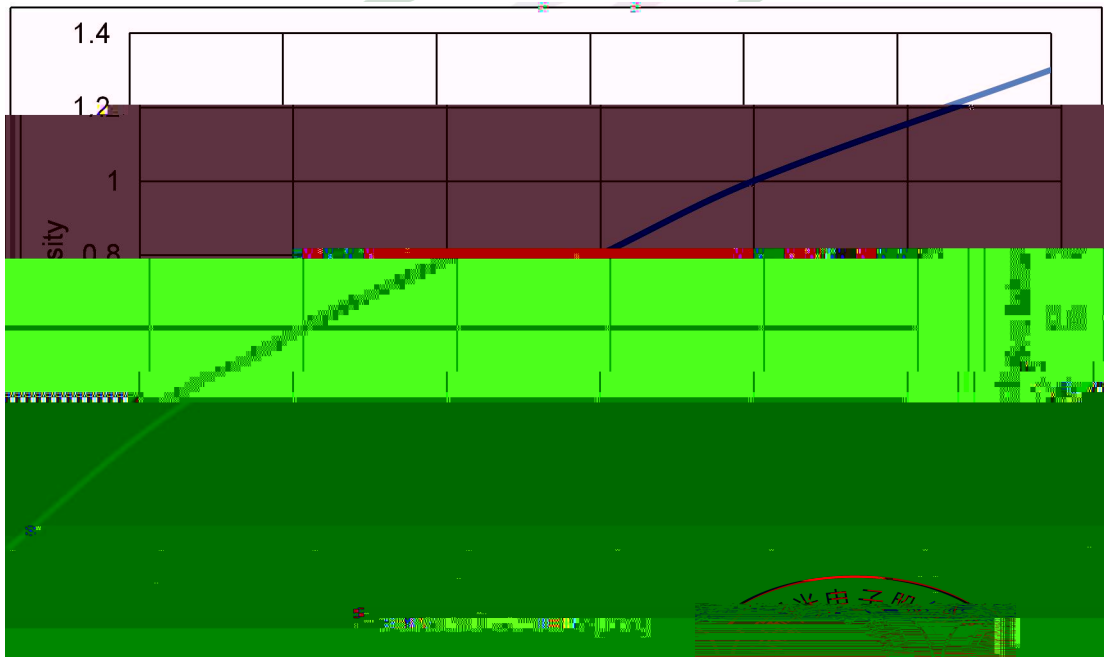
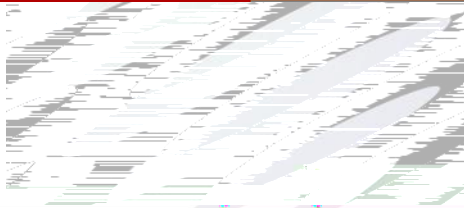
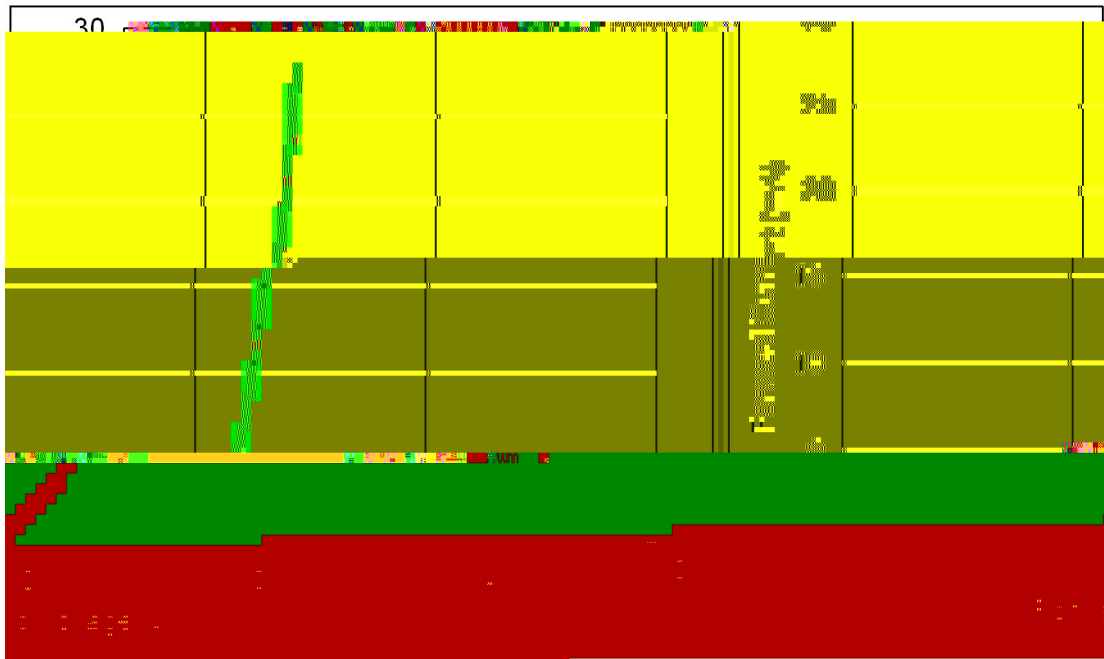

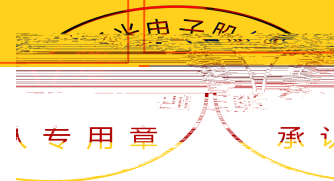
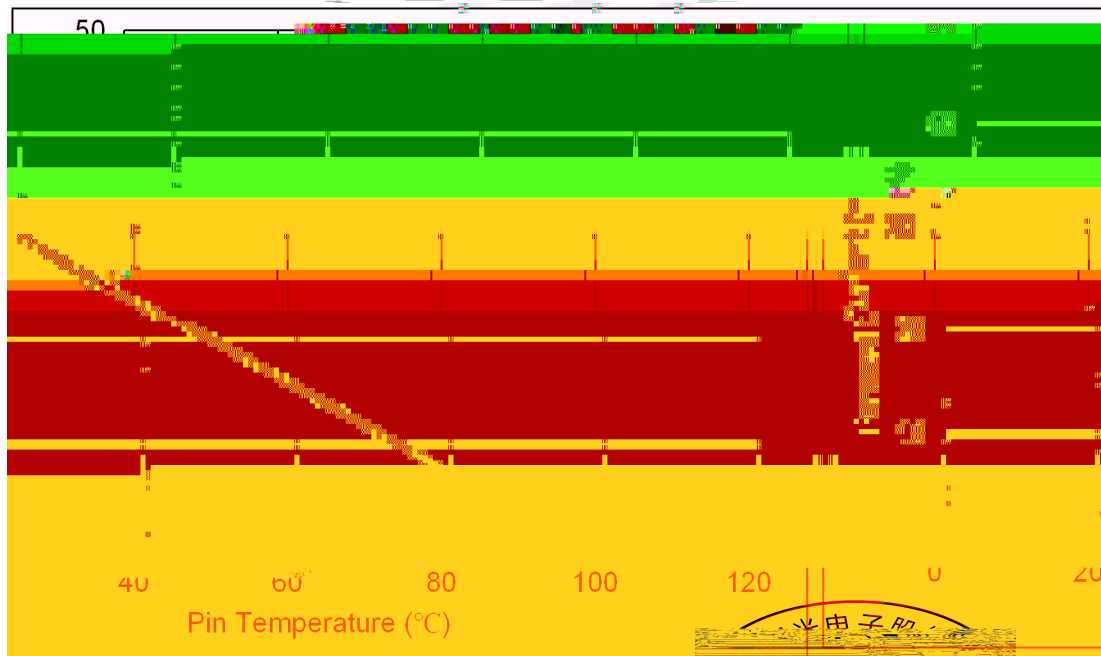
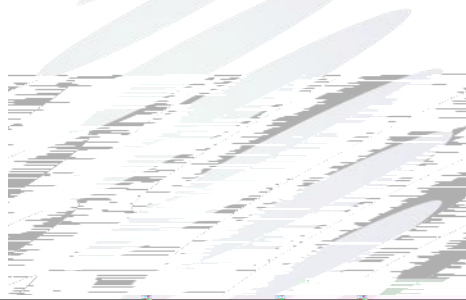
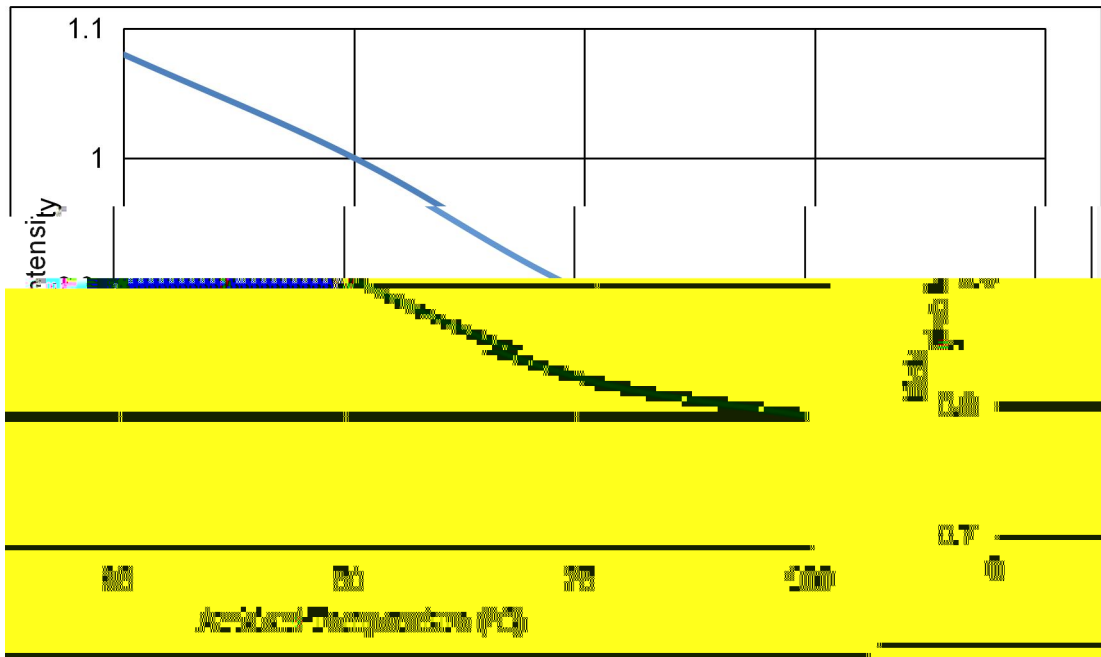

瑞豐光電  
 (專用章 承認)



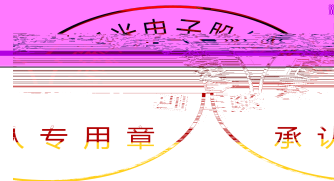
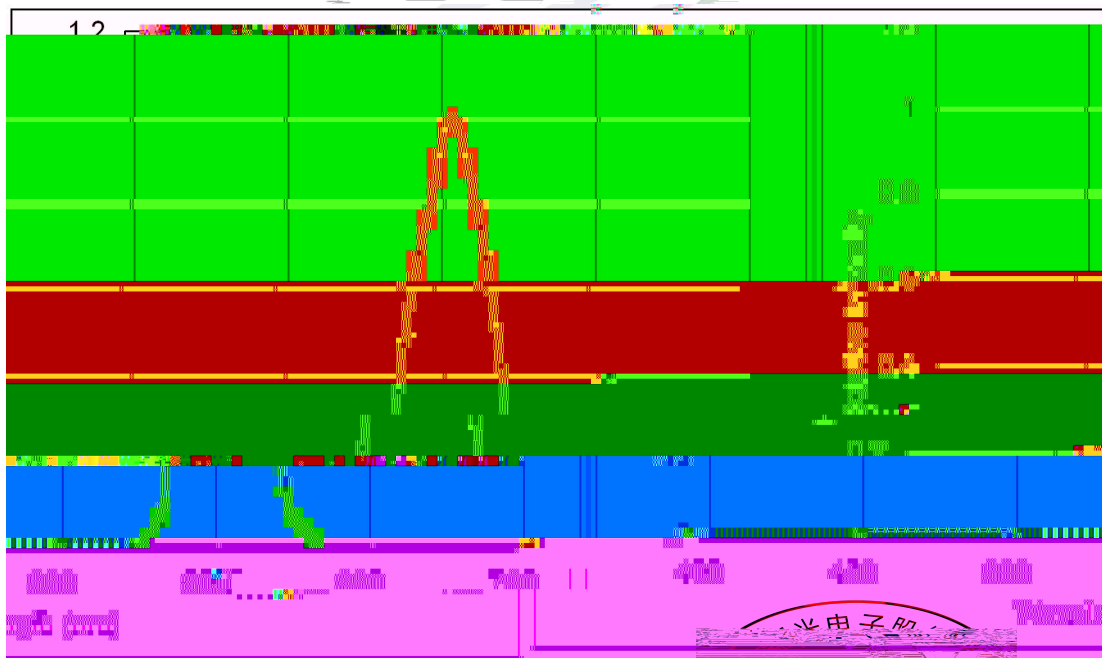
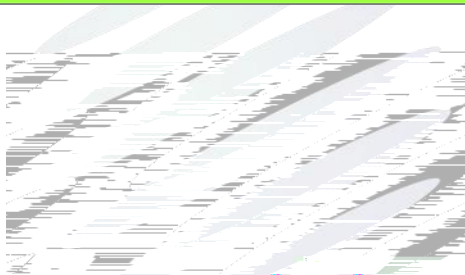
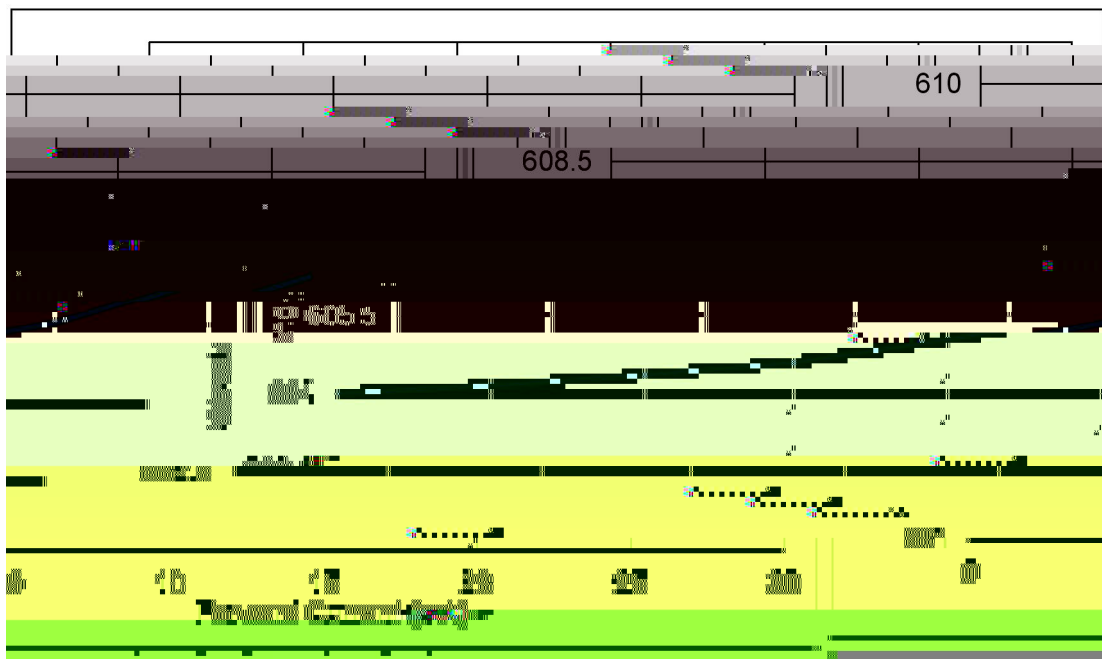



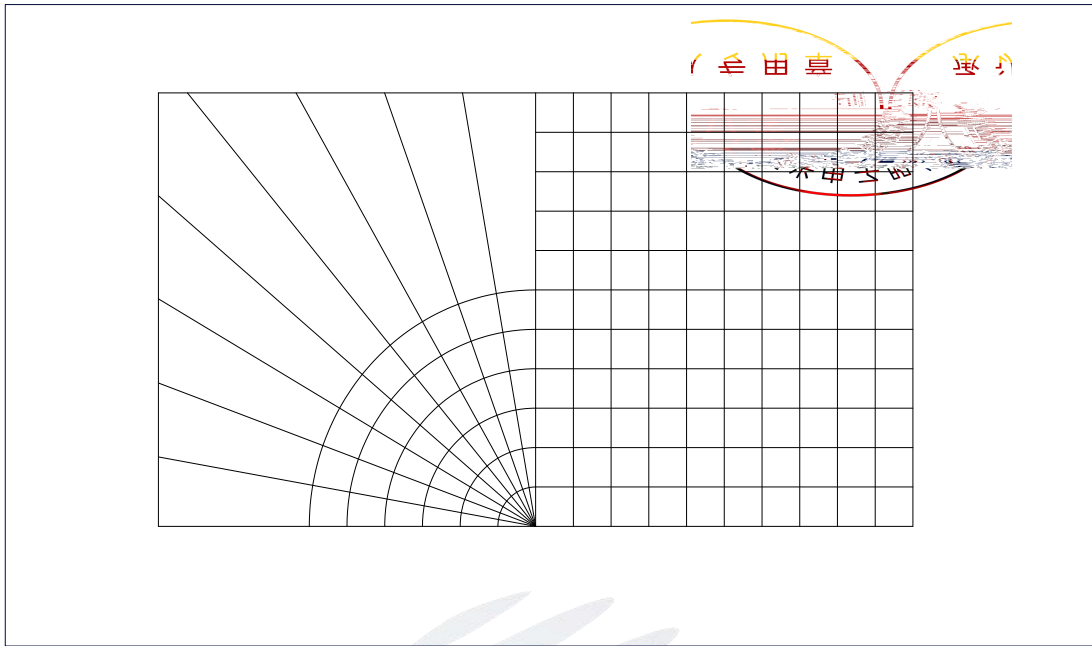

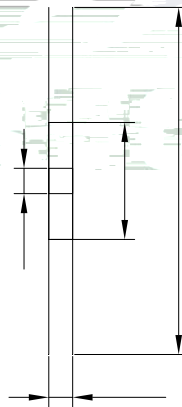
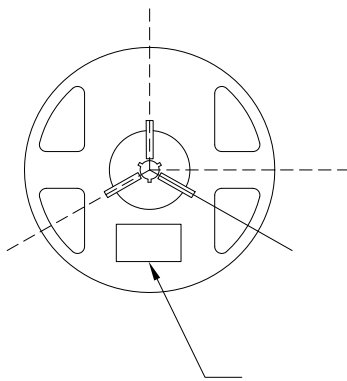
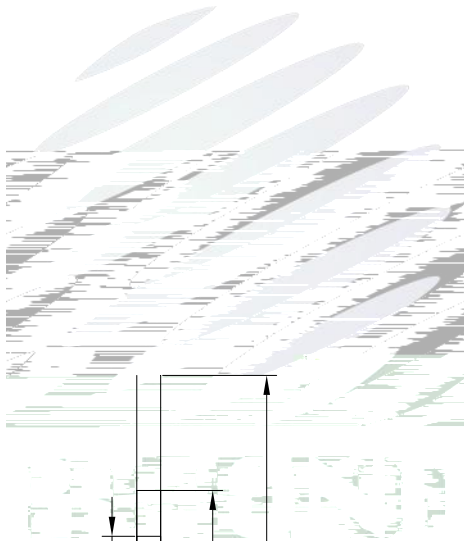





			Min.	

