

±

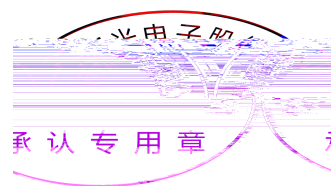



| | | | |
|--|--|--|--|
| | | | |
| | | | |
| | | | |
| | | | |
| | | | |
| | | | |
| | | | |
| | | | |
| | | | |





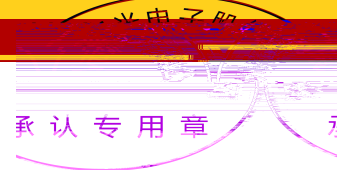
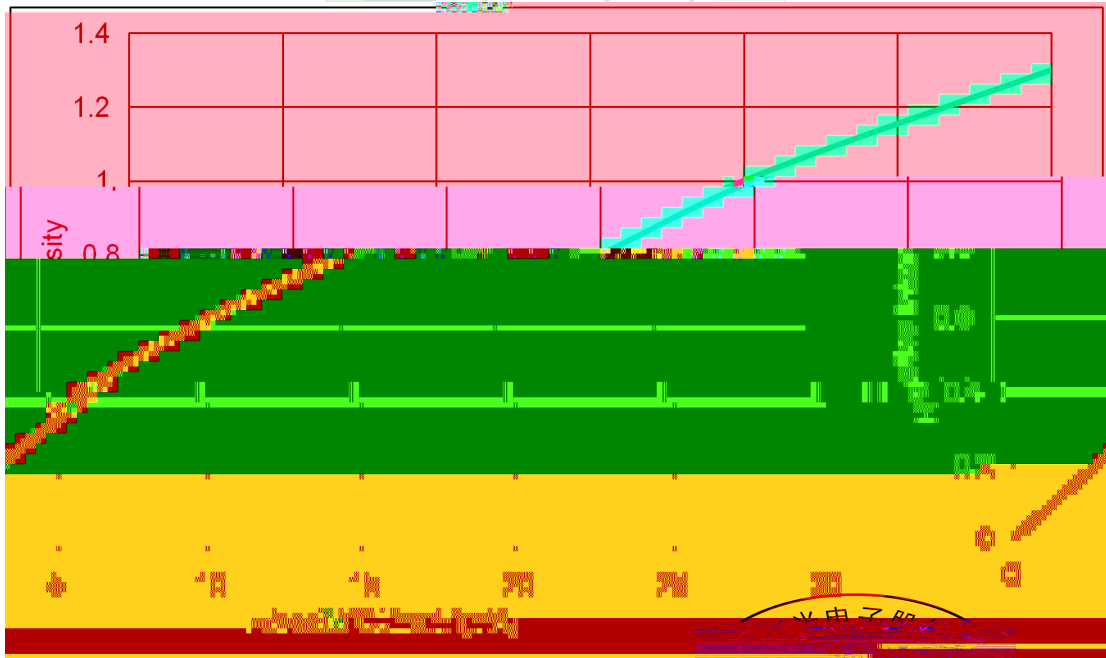
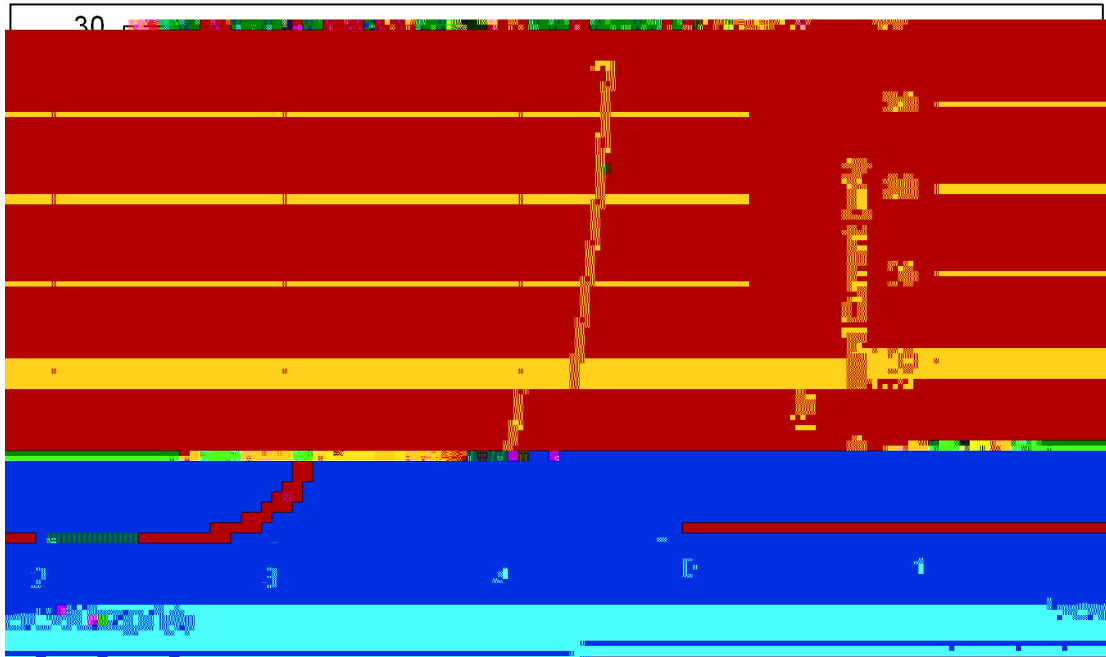

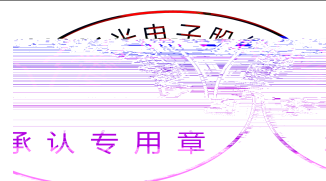
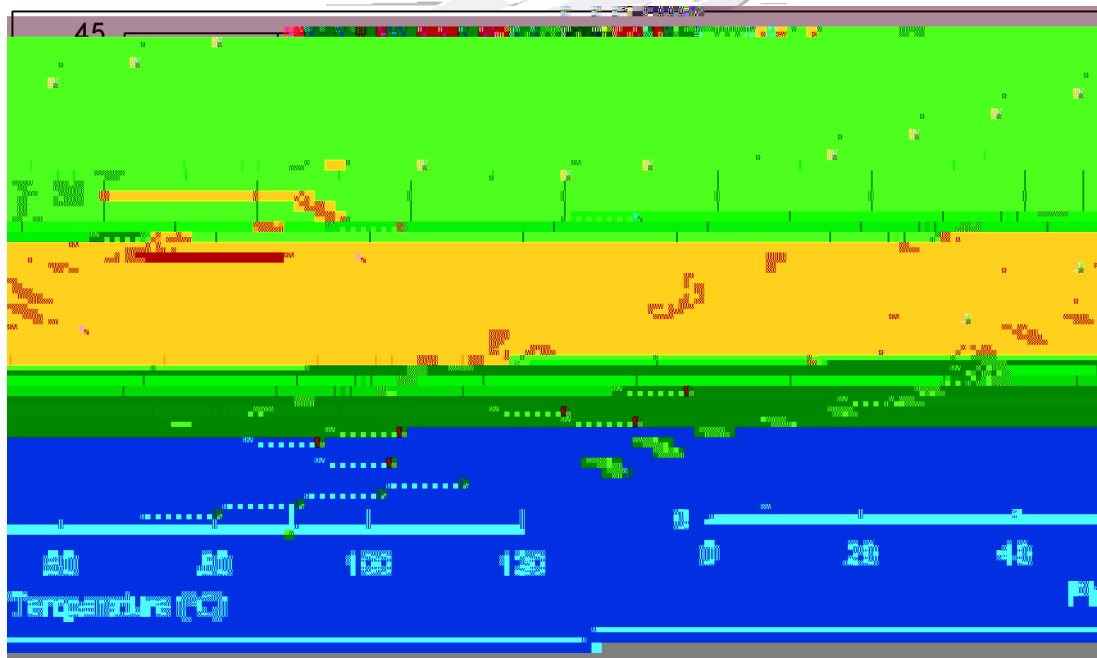
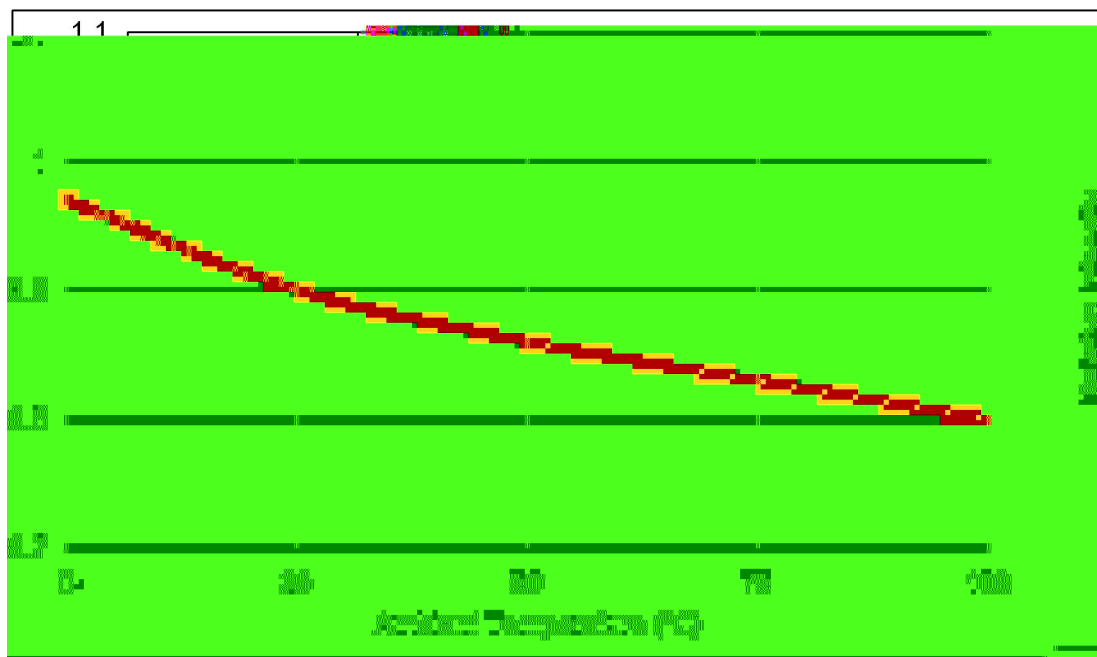

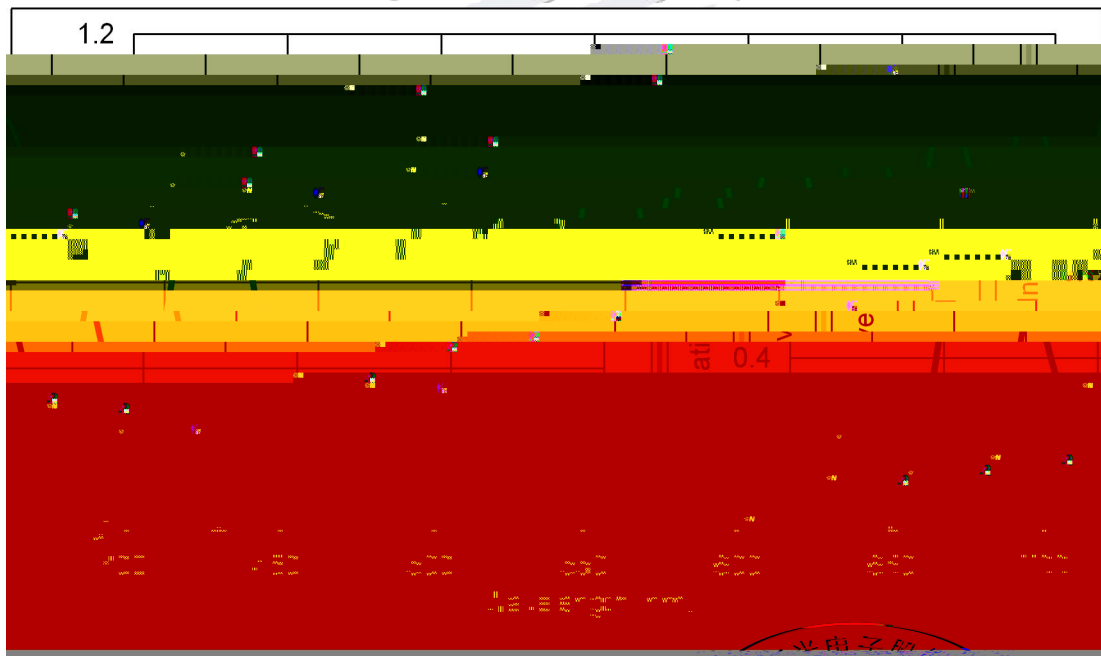
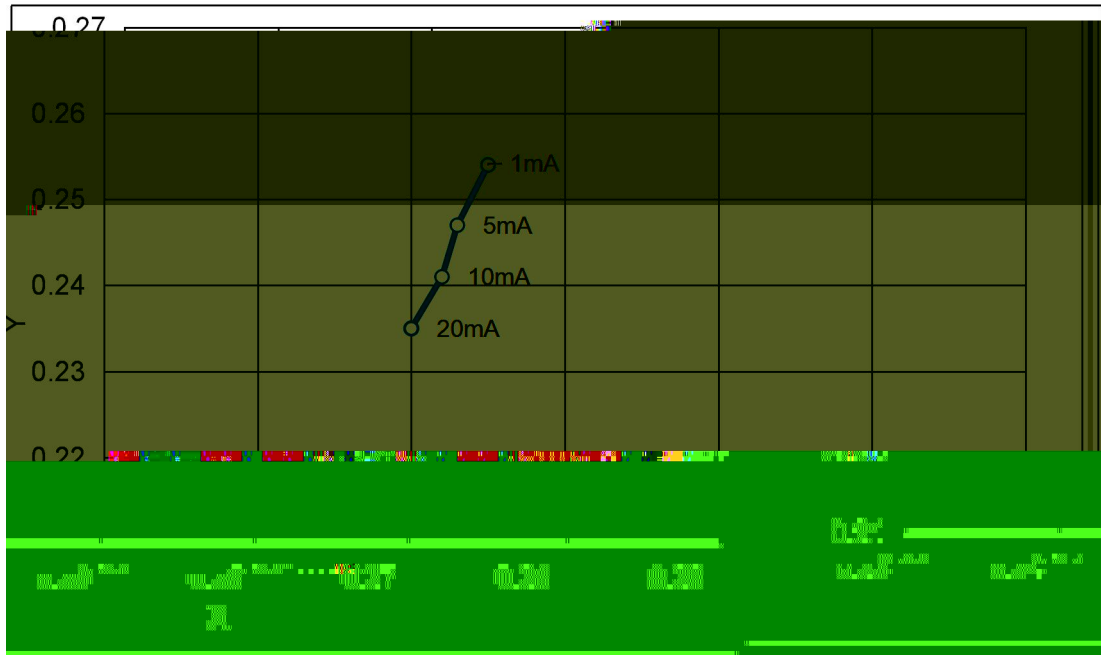

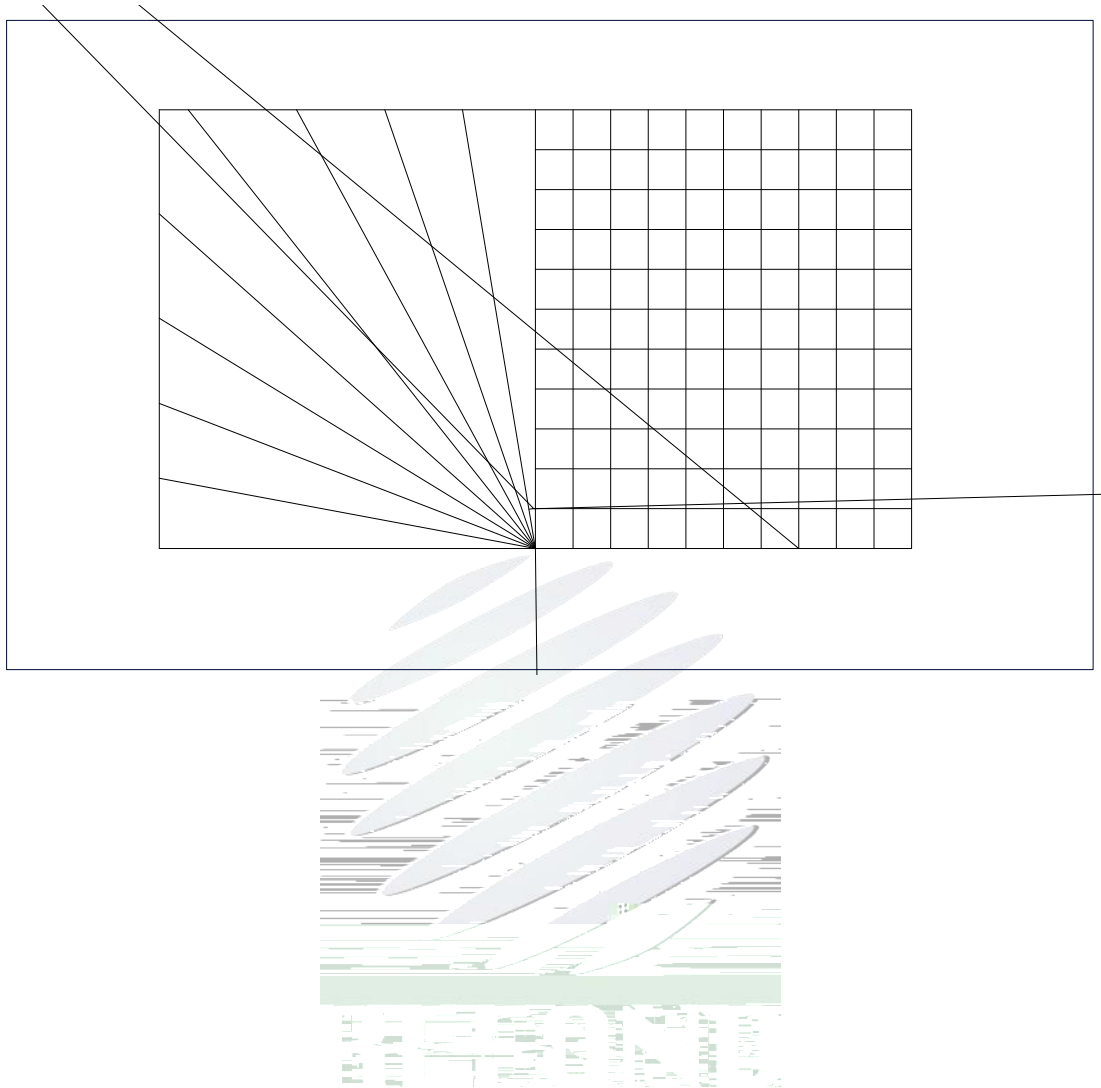

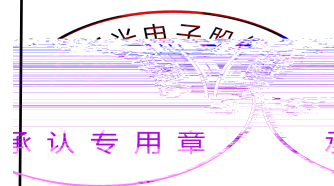
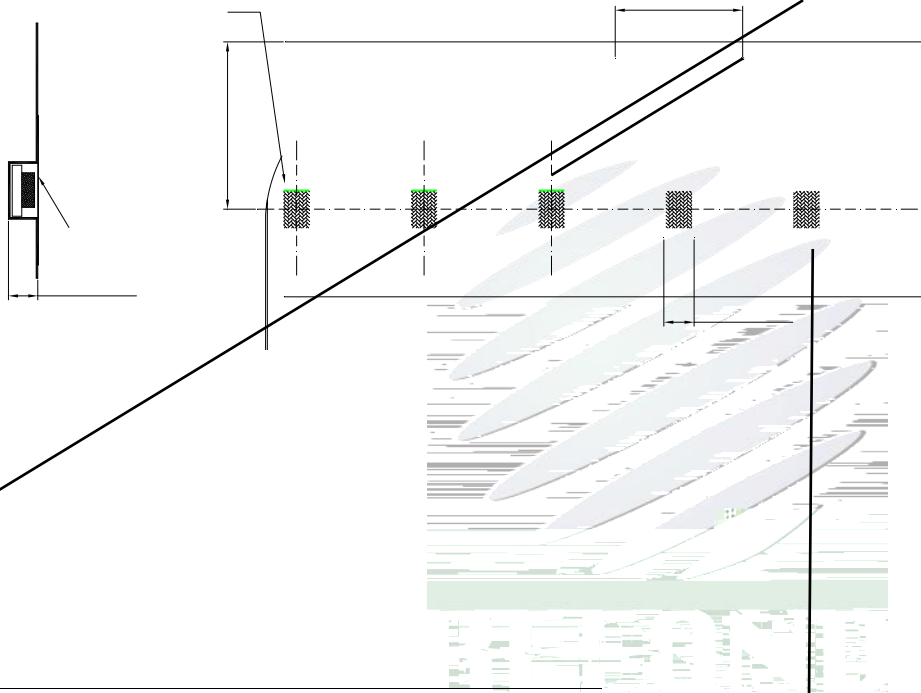

PART NO: _____
 SPEC NO: _____
 LOT NO: _____

BIN CODE:
 Φ: _____ XY: _____
 VF: _____ WLD: _____

QTY: _____
 DATE: _____

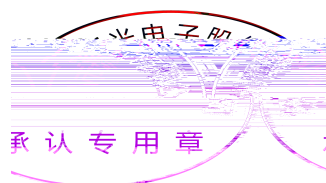
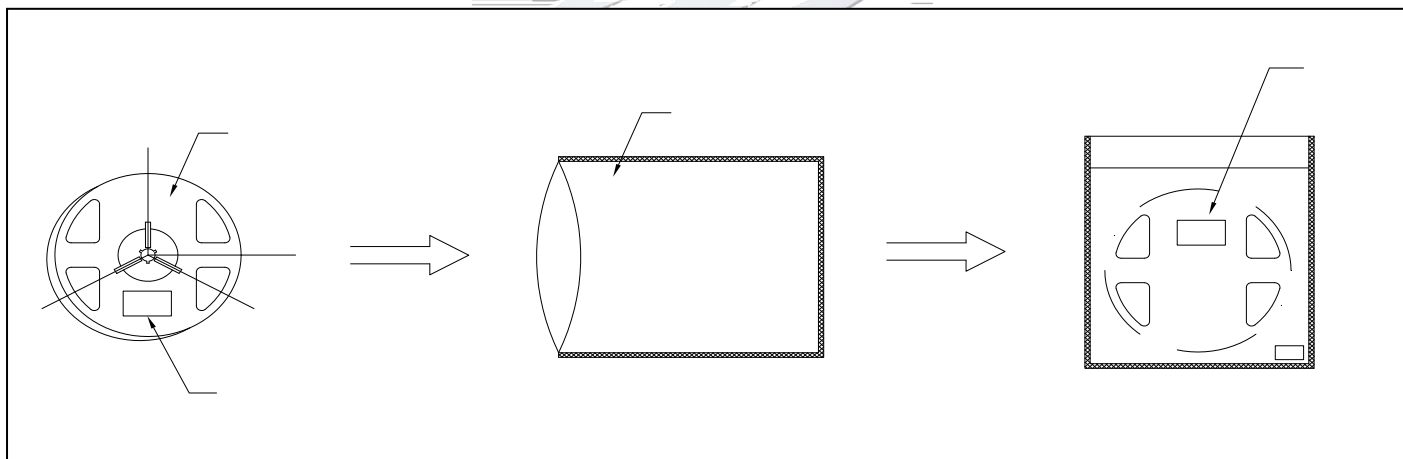



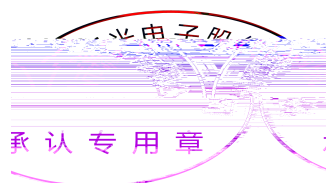
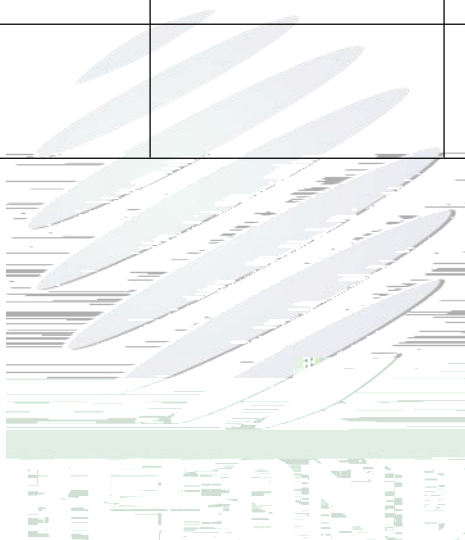

| | | | | |
|--|--|--|--|--|
| | | | | |
| | | | | |
| | | | | |
| | | | | |



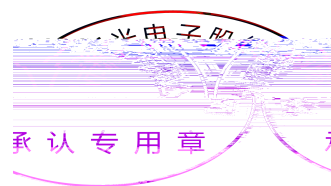

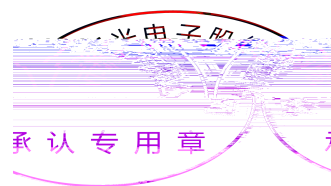





| | | | | |
|--|--|--|--|--|
| | | | | |
| | | | | |
| | | | | |
| | | | | |

