

# SPECIFICATION 产品规格书

REFOND P/N 产品型号

RF-E30Q0-IRZ-FR

R&D 研发

Mass Product 量产供货

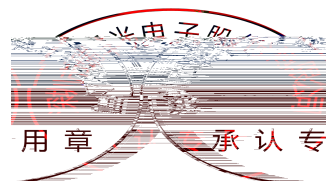

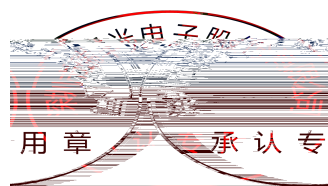

# 1. Description

## 1.1 产品描述

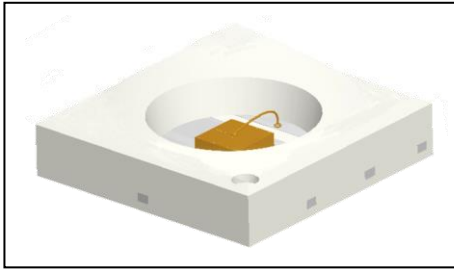

This product uses the EMC package, it has a high reliability. it also be widely application for security monitoring and senso.

Size(mm): 3.00mmX3.00mmX0.52mm.

本产品采用EMC封装结构，可靠性高。广泛运用于各种安防监控和传感器的电子产品中。

产品尺寸：3.00mmX3.00mmX0.52mm

## 1.2 Features

Low forward voltage.

峰值波长 850nm

Pb-free reflow soldering application. 无铅回流焊应用

Moisture sensitive level:Level3. 防潮等级：Level 3

RoHS compliant. 符合RoHS

## 1.3 Application 产品应用

Surveillance systems. 监视系统

Infrared Illumination for cameras. 红外相机

Machine vision systems. 机器视觉系统

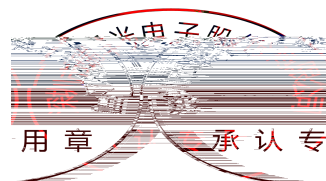

## 1.4 Package Dimension 封装尺寸

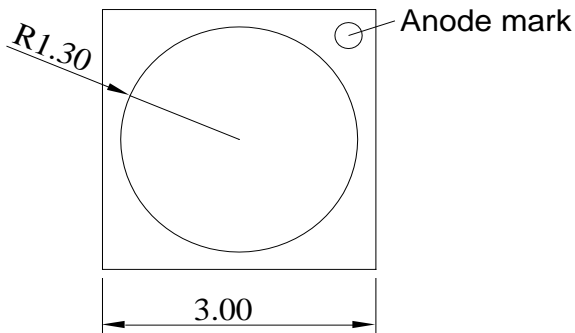

Fig.1-1 Top view 正面视图

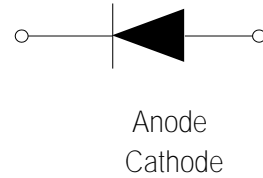

Fig.1-2 Polarity 极性

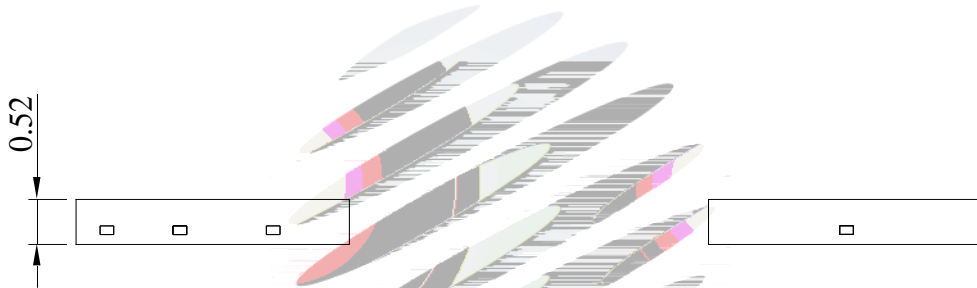

Fig.1-3 Side view 侧面视图

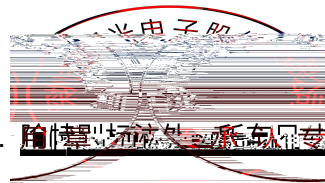

Fig.1-4 Bottom view 背面视图

Fig.1-5 Soldering patterns 推荐焊盘

### Notes 备注:

1. All dimensions units are millimeters. 所有尺寸标注单位为毫米
2. All dimensions tolerances are  $\pm 0.2\text{mm}$  unless otherwise noted. 除另有标注外, 所有尺寸公差均为  $\pm 0.2$  毫米



## 1.5 Product Parameters 产品参数

Table 1-1 Electrical / Optical Characteristics at Ts=25°C 电性与光学特性

| Item<br>项目                | Symbol<br>符号 | Test Condition<br>测试条件 | Value         |              |               | Unit<br>单位 |
|---------------------------|--------------|------------------------|---------------|--------------|---------------|------------|
|                           |              |                        | Min.<br>(最小值) | Typ<br>(典型值) | Max.<br>(最大值) |            |
| Reverse Current<br>(漏电流)  | $I_R$        | $V_R=5V$               | ---           | ---          | 10            | $\mu A$    |
| Forward Voltage<br>(正向电压) | $V_F$        | $I_F=650mA$            | ---           | 1.7          | 1.8           | V          |
| Peak Wavelength<br>(峰值波长) | $\lambda_p$  | $I_F=650mA$            | 830           | 850          | ---           | nm         |

Spectrum Radiation  
Bandwidth

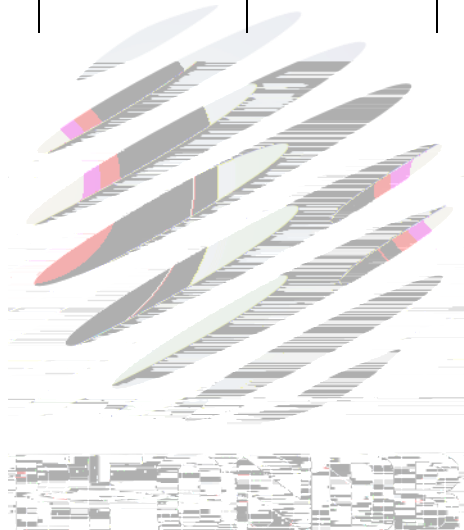

Table 1-2 Absolute Maximum Ratings at Ts=25°C 绝对最大值

| Parameter (参数)                     | Symbol (符号)      | Rating (值) | Units (单位) |
|------------------------------------|------------------|------------|------------|
| Power Dissipation (功耗)             | P <sub>D</sub>   | 1.3        | W          |
| Forward Current (正向电流)             | I <sub>F</sub>   | 650        | mA         |
| Reverse Voltage (反向电压)             | V <sub>R</sub>   | 5          | V          |
| Electrostatic Discharge (HBM) (静电) | E <sub>SD</sub>  | 2000       | V          |
| Operating Temperature (操作温度)       | T <sub>OPR</sub> | -40 ~ +85  |            |
| Storage Temperature (储存温度)         | T <sub>STG</sub> | -40 ~ +85  |            |
| Junction Temperature (结温)          | T <sub>J</sub>   | 105        |            |

Notes 备注:

- 1.1/10 Duty cycle, 0.1ms pulse width. 脉宽0.1ms,占空比1/10.
- 2.The above forward voltage measurement allowance tolerance is ±0.1V. 以上所示电压测量误差 ±0.1V.
3. Tolerance of measurement of Total radiant flux/ Radiant Intensity:±10%.辐射功率/强度测量公差: ±10%.
4. Care is to be taken that power dissipation does not exceed the absolute maximum rating of the product. 使用功率不能超过规定的最大值。
5. All measurements were made under the standardized environment of Refond. 所有测试都是基于瑞丰光电标准测试平台。
- 6.When the LEDs are in operation the maximum current should be decided after measuring the package temperature , junction temperature should not exceed the maximum rate. LED使用的最大电流需要根据散热条件确定, 结温不能超过最大值。
7. ESD yield is over 90% at 2000V ESD (HBM). ESD protection during products handling is needed. 90%的LED通过人体模式ESD2000V 测试, 在操作时请注意静电防护。



## 1.6 Typical optical characteristics curves 典型光学特性曲线

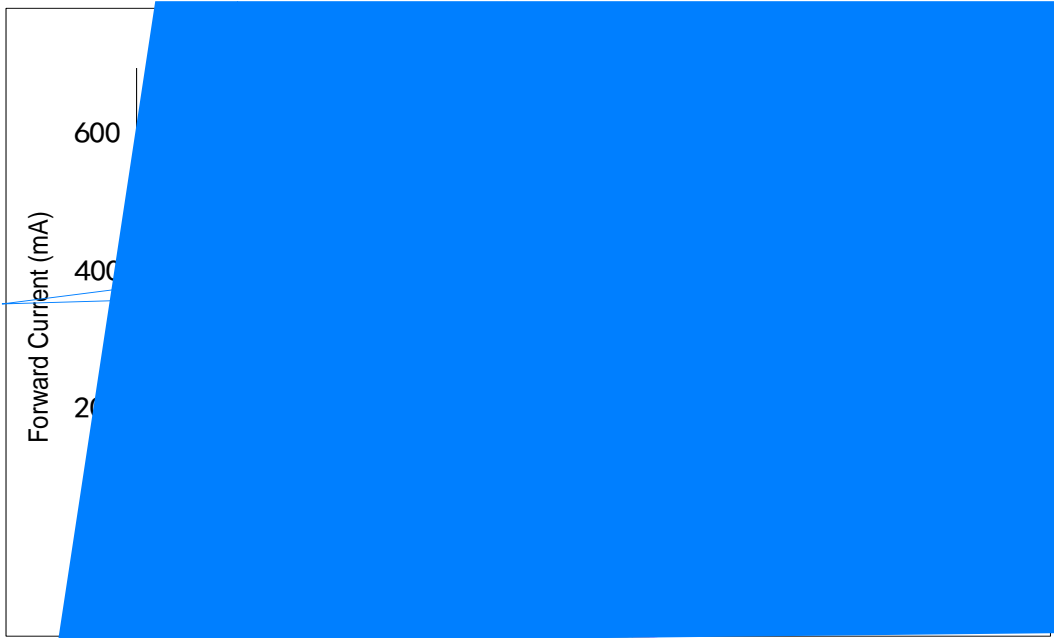

Fig 1-6 Forward Voltage Vs. Forward Current 伏安特性曲线

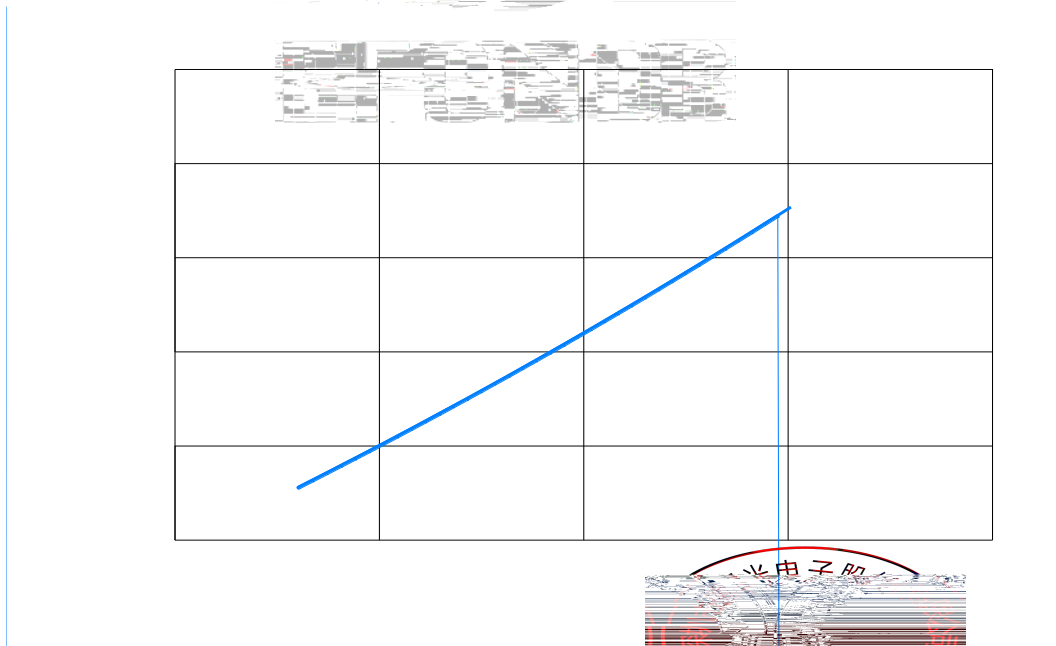

Fig 1-7 Forward Current Vs. Relative Intensity 正向电流与相对光强特性曲线

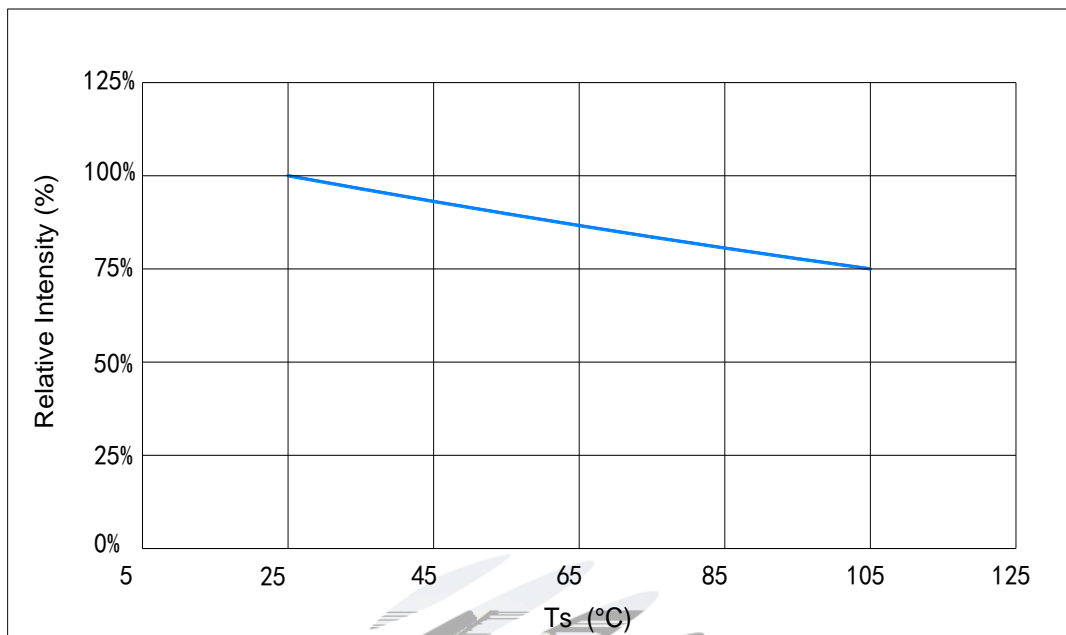

Fig 1-8 Ts Temperature Vs Relative Intensity 管脚温度与相对光强特性曲线

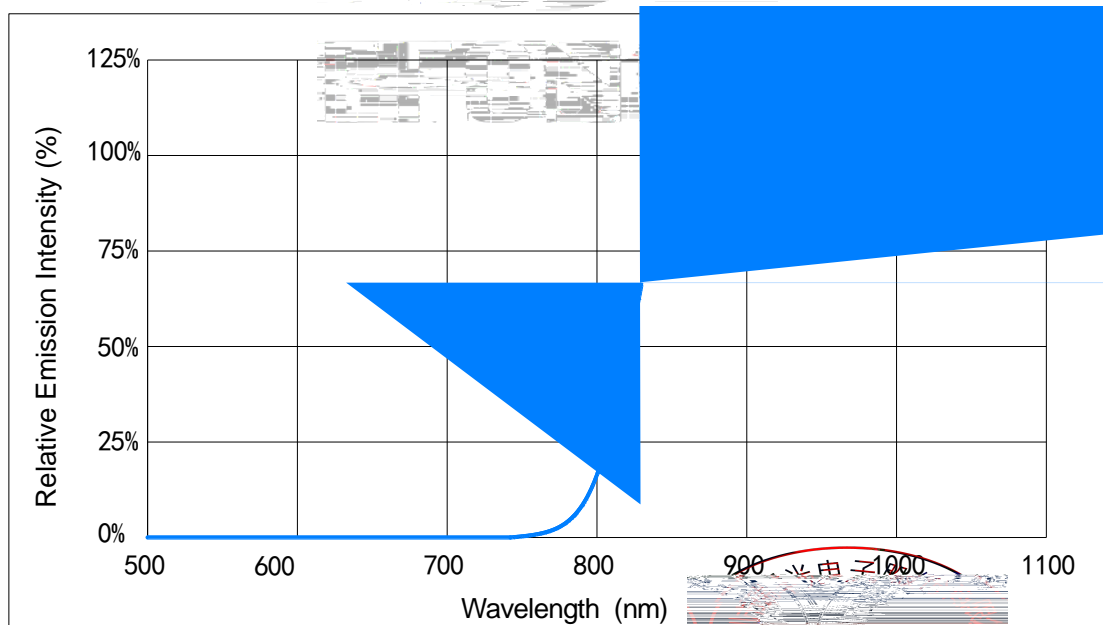

Fig 1-9 Spectrum Distribution 光谱分布特性曲线



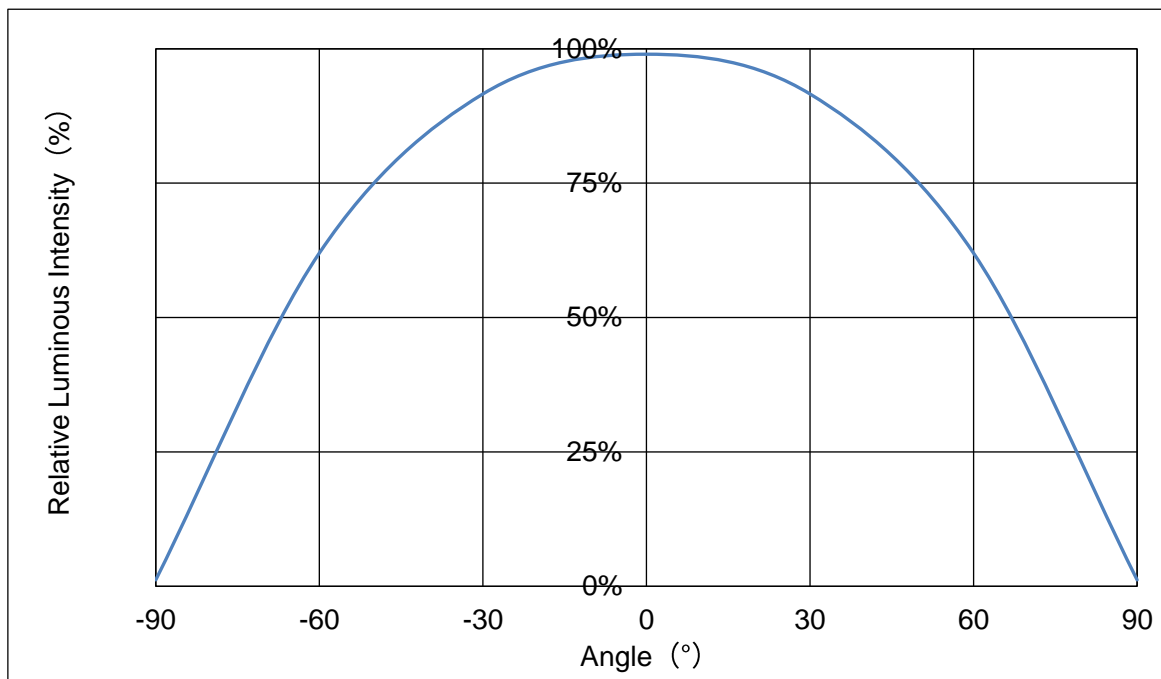

Fig 1-10 Radiation diagram 辐射特性曲线

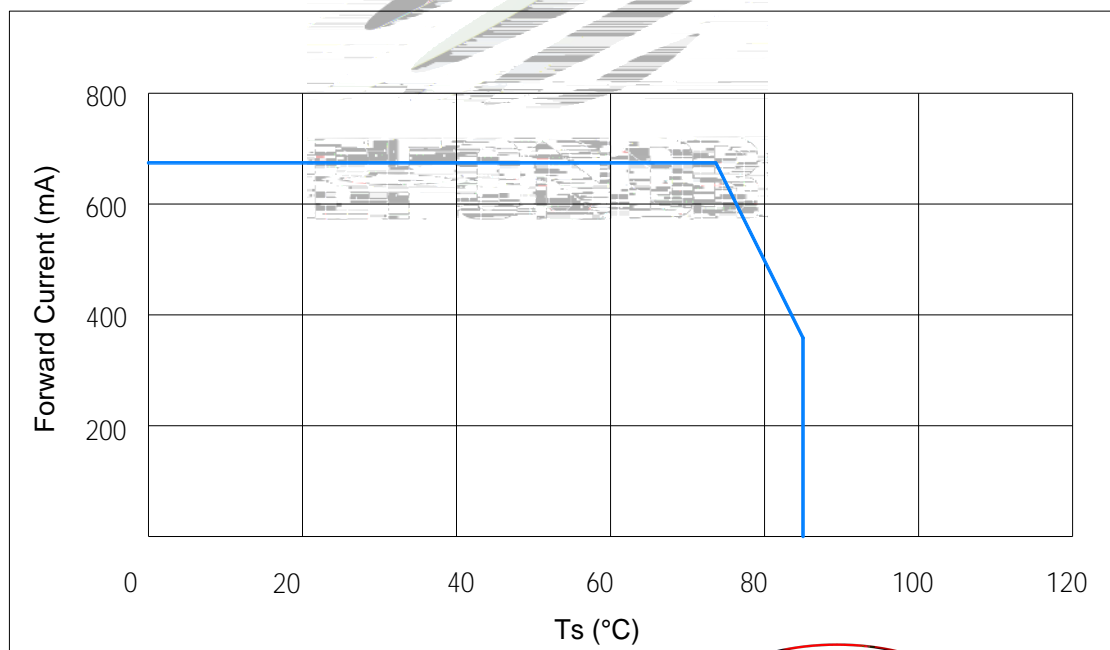

Fig 1-11 Ts Temperature Vs Forward Current 管脚温度与正向电流特性曲线



## 2. Packaging 产品包装

### 2.1 Packaging Specification 包装规格

Package:5000pcs/reel.包装每卷 5000pcs。

#### 2.1.1 Carrier Tape Dimension 载带尺寸

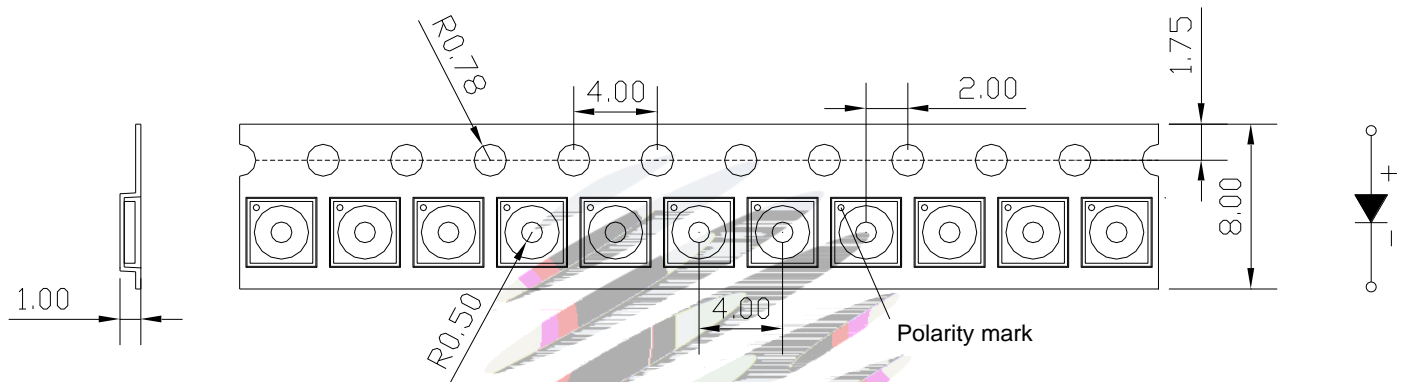

Fig.2-1 Carrier Tape Dimension 载带尺寸

#### 2.1.2 Reel Dimension 卷盘尺寸

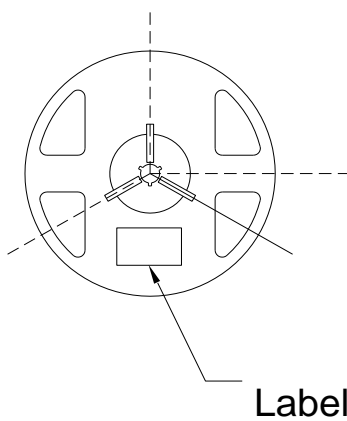

Fig.2-2 Reel Dimension 卷盘

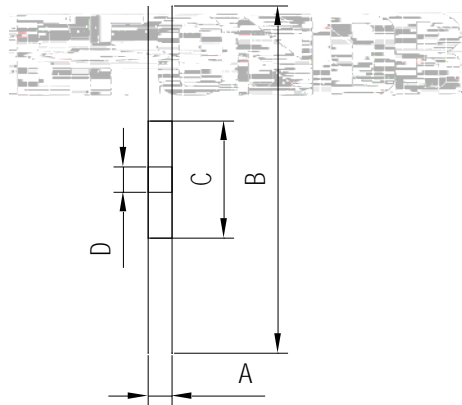
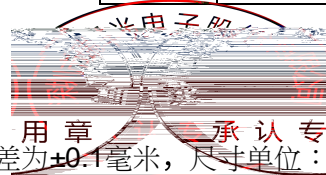

Table 2-1 Dimension 尺寸

|   |            |
|---|------------|
| A | 8.5±0.3mm  |
| B | 178.0±2mm  |
| C | 59.0±1mm   |
| D | 13.3±0.2mm |

Notes 备注:

The tolerances unless mentioned ±0.1mm. Unit : mm 注：未注公差为±0.1毫米，尺寸单位：毫米。



### 2.1.3 Label Form Specification 标签规格

Table 2-2 Label Form Specification 标签规格

Fig 2-3 Label Form Specification 标签规格

## 2.2

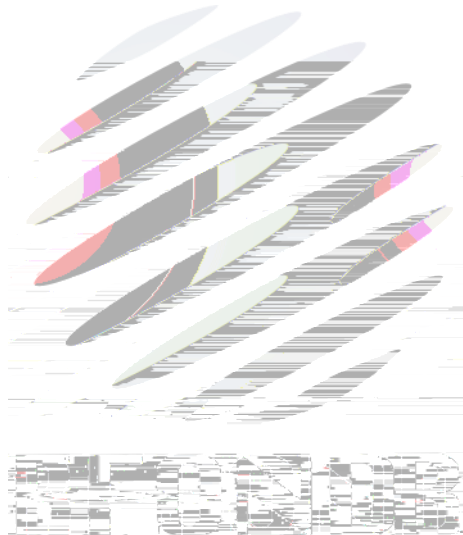

## 2.4 Reliability Test Items And Conditions 信赖性测试项目及条件

Table 2-3 Reliability Test Items And Conditions 信赖性测试项目及条件

| Test Items<br>项目                 | Ref.Standard<br>参考标准 | Test Condition<br>测试条件            | Time<br>时间 | Quantity<br>数量 | Ac/Re<br>接收/拒收 |
|----------------------------------|----------------------|-----------------------------------|------------|----------------|----------------|
| Reflow<br>回流焊                    | JESD22-B106          | Temp:260°Cmax<br>T=10 sec         | 3times.    | 10pcs          | 0/1            |
| Temperature Cycle<br>温度循环        | JESD22-A106          | 100°C 30 min.<br>-40°C 30 min.    | 100 cycles | 10Pcs.         | 0/1            |
| Thermal Shock<br>冷热冲击            | JESD22-A104          | -40°C 15min<br>10s<br>100°C 15min | 300 cycles | 10pcs.         | 0/1            |
| High Temperature Storage<br>高温保存 | JESD22-A103          | Temp:100°C                        | 1000hrs.   | 10pcs          | 0/1            |
| Low Temperature Storage<br>低温保存  | JESD22-A119          | Temp:-40°C                        | 1000hrs.   | 10pcs.         | 0/1            |
| Life Test<br>常温通电                | JESD22-A108          | Ta=25°C<br>If=650mA               | 1000hrs.   | 10pcs.         | 0/1            |



## 2.5 Criteria For Judging Damage 失效判定标准

Table Criteria For Judging Damage 失效判定标准

| Test Items<br>项目           | Symbol<br>符号 | Test Condition<br>测试条件 | Criteria For Judgement<br>判定标准 |             |
|----------------------------|--------------|------------------------|--------------------------------|-------------|
|                            |              |                        | Min. 最小                        | Max. 最大     |
| Forward Voltage<br>正向电压    | $V_F$        | $I_F=650\text{mA}$     | -                              | U.S.L*)x1.1 |
| Reverse Current<br>反向电流    | $I_R$        | $V_R = 5V$             | -                              | U.S.L*)x2.0 |
| Total radiant flux<br>辐射功率 | e            | $I_F=650\text{mA}$     | L.S.L*)x0.7                    | -           |

Notes 备注:

1.U.S.L: Upper standard level

### 3. SMT Reflow Soldering Instructions SMT 回流焊说明

#### 3.1 SMT Reflow Soldering Instructions SMT 回流焊说明

Fig.3-1

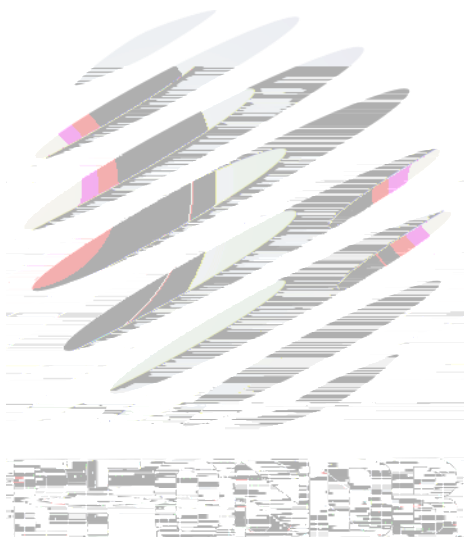

Notes 备注:

- (1) Reflow soldering should not be done more than two times.回流焊次数不可以超过两次。
- (2) When soldering , do not put stress on the LEDs during heating.当焊接时,不要在材料受热时用力压胶体表面。

### 3.1.1 Soldering Iron 烙铁焊接

- (1) When hand soldering, keep the temperature of iron below less 300°C less than 3 seconds  
当手工焊接时,烙铁的温度必须小于300°C,时间不可超过3秒。
- (2) The hand solder should be done only one time.手工焊接只可焊接一次。

### 3.1.2 Repairing 修补

Repair should not be done after the LEDs have been soldered. When repairing is unavoidable,a double-head soldering iron should be used (as below figure). It should be confirmed in advance whether the characteristics of LEDs will or will not be damaged by repairing.

LED回流焊后,如需修补,必须使用双头烙铁,而且需事先确认此烙铁是否会损坏LED本身的特性。

### 3.1.3 Cautions 注意事项

- (1) The encapsulated material of the LEDs is silicone. Therefore the LEDs have a soft surface on the top of package. The pressure to the top surface will be influence to the reliability of the LEDs. Precautions should be taken to avoid the strong pressure on the encapsulated part. So when use the picking up nozzle, the pressure on the silicone resin should be proper. LED封装胶为硅胶,表面较软,用力按压胶体表面会影响LED可靠性,因此应有预防措施避免在按压器件。当使用吸嘴时,胶体表面的压力应是恰当的。
- (2) Components should not be mounted on warped (non coplanar) portion of PCB. After soldering, do not warp the circuit board.LED 灯珠不要焊接在弯曲的 PCB 板上,焊接之后,也不要弯折线路板。
- (3) Do not apply mechanical force or excess vibration during the cooling process to normal temperature after soldering. Do not rapidly cool device after soldering. 回流焊之后冷却过程中,不要对材料实加外力,也不要震动,回流焊后,不要采用激剧冷却的方式。

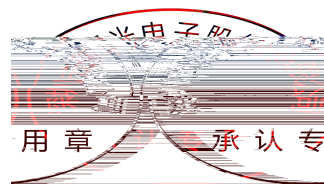

## 4. Handling Precautions 产品使用注意事项

### 4.1 Handling Precautions 产品使用注意事项

(1) LED operating environment and sulfur element composition cannot be over 100PPM in the LED mating usage material. This is provided for informational purposes only and is not a warranty or endorsement. LED 工作环境及与 LED 适配的材料中硫元素含量不得超过100PPM.这只是一个建议，不作任何品质担保。

(2) In order to prevent external material from getting into the inside of LED, which may cause the malfunction of LED, the single content of Bromine element is required to be less than 900PPM, the single content of Chlorine element is required to be less than 900PPM, the total content of Bromine element and Chlorine element in the external materials of the application products is required to be less than 1500PPM. This is provided for informational purposes only and is not a warranty or endorsement. 为了防止外界物质进入LED内部以造成LED的损伤，所处环境及所用套件等等，单一的溴元素含量要求小于900PPM，单一氯元素含量要求小于900PPM，溴元素与氯元素总含量必须小于1500PPM。这只是一个建议，不作任何品质担保。

(3) VOCs (Volatile organic compounds) emitted from materials used in the construction of fixtures can penetrate silicone encapsulants of LEDs and discolor when exposed to heat and photonic energy. The result can be a significant loss of light output from the fixture. Knowledge of the properties of the materials selected to be used in the construction of fixtures can help prevent these issues. Refond advises against the use of any chemicals or materials that have been found or are suspected to have an adverse affect on device performance or reliability. To verify compatibility, Refond recommends that all chemicals and materials be tested in the specific application and environment for which they are intended to be used. Attaching LEDs, do not use adhesives that outgas organic vapor. 应用套件中的挥发性物质会渗透到LED内部，在通电产生光子及热的条件下，会导致LED产生这些问题。瑞丰反对使用任何对LED有害，进而造成严重光衰，提前了解套件材料能够LED器件的性能或者可靠性有害的物质或材料，不管这些材料是已经证实了的还是仅仅怀疑有害。针对特定的用途和使用环境，瑞丰建议对所有的物质和材料进行相容性的测试。在贴装LED时候，不要使用能产生有机挥发性气体的粘结剂。

(4) Handle the component along the side surface by using forceps or appropriate tools; do not directly touch or Handle the silicone lens surface, it may damage the internal circuitry. 通过侧面适当的工具材料侧面取取，避免直接触碰硅透镜表面，可能会损坏内部电路。

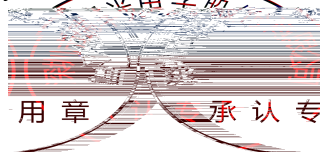



Fig 4-1

(5) In designing a circuit, the current through each LED can not be exceed the absolute maximum rating specified for each LED. In the meanwhile, resistors for protection should be applied, otherwise slight voltage shift will cause big current change, burn out may happen. The driving circuit must be designed to allow forward voltage only when it is ON or OFF. If the reverse voltage is applied to LED, migration can be generated resulting in LED damage. 设计电路时，通过 LED 的电流不能超过规定的最大值，同时，还需使用保护电阻，否则，微小的电压变化引起较大电流变化可能烧毁 LED。电路设计必须保证只有在开启或者关闭的时候出现正向电压的变化，不要施加反压，否则会损坏 LED。

(6) Thermal Design is paramount importance because heat generation may result in the Characteristics decline, such as brightness decreased, Color change and so on. Please consider the heat generation of the LEDs when making the system design. LED 容易因为自身的发热和环境的温度改变而改变，温度升高会降低 LED 发光效率，影响发光颜色，所以在设计时应充分考虑散热问题。

(7) Compared to standard encapsulants, silicone is generally softer, and the surface is more likely to attract dust, requiring special care during processing. In cases where a minimal level of dirt and dust particles cannot be guaranteed, a suitable cleaning solution must be applied to the surface after the soldering of components. Refond suggests using isopropyl alcohol for cleaning. In case other solvents are used, it must be assured that these solvents do not dissolve the package or resin. Ultrasonic cleaning is not recommended. Ultrasonic cleaning may cause damage to the LED. 与其他封装胶相比，硅胶通常较软，表面易吸附脏物，应用时应特别注意。当对产品洁净度要求较高时，回流焊以后需要采用恰当的清洗方式，我们推荐用异丙醇作清洗剂。如需用



Table 4-1 Storage 儲存

| Conditions<br>种类 |                                    | Temperature | Humidity<br>湿度 | Time<br>时间              |
|------------------|------------------------------------|-------------|----------------|-------------------------|
| Storage          | Before Opening Aluminum Bag<br>拆包前 | 30°C        | 75%            | Within 1 Year From Date |
|                  | After Opening Aluminum Bag<br>拆包后  | 30°C        | 60%            | 168hours<br>168小时       |
| Baking<br>烘烤     |                                    | 60±5°C      | -              | ≥24hours<br>大于24小时      |

(8) If the moisture absorbent material (silica gel) has faded away or the LEDs have exceeded the storage time, baking treatment should be performed after unpacking and based on the following condition (60±5) °C for above 24 hours. 如果干燥剂或包装失效，或者产品不符合以上有效储存条件，需拆包后进行烘烤，烘烤条件：60±5°C，大于24小时。

If the package is flatulence or damaged, please notify the sales staff to assist. 如果包装胀气或者破损，请通知销售人员协助处理。

(9) Similar to most Solid state devices; LEDs are sensitive to Electro-Static Discharge (ESD) and Electrical Over Stress (EOS). 像其他的半导体电子器件一样，LED对静电过流击穿非常敏感，需要做好防护。

(10) Other points for attention, please refer to our relevant information.

